

Managing Your Woodland

A Non-forester's Guide To Small-scale Forestry in British Columbia

March 2002

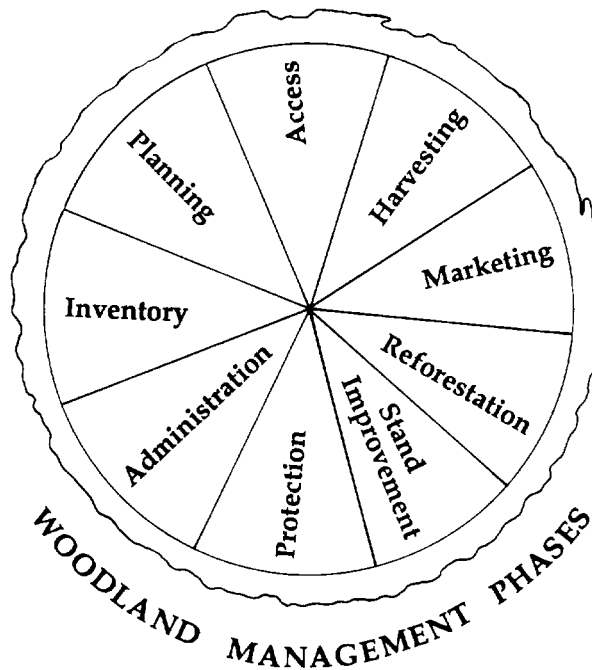

Supporting Management of Forest Resources on Private Land in BC



Natural Resources Canada
Canadian Forest Service

Ressources naturelles Canada
Service canadien des forêts

National Library of Canada Cataloguing in Publication Data

Main entry under title:

Managing you woodland : a non-forester's guide to small-scale forestry in British Columbia. – 2002 ed.

“Updated and revised by ECON Consulting.”–

Acknowledgements.

Co-published by Small Woodlands Program of BC and Canadian Forest Service.

Previously published by Forestry Canada, 1992.

Includes bibliographical references: p.

ISBN 0-7726-4776-3

1. Woodlots – British Columbia – Management. 2. Forests and forestry – British Columbia. 3. Forest management – British Columbia. 4. Agroforestry – British Columbia. I. British Columbia. Ministry of Forests. II. ECON Consulting. III. Small Woodlands Program of BC. IV. Canadian Forest Service.

SD146.B7M38 2002

634.9'9'09711

C2002-960100-2

© Her Majesty the Queen in Right of Canada, 2002
Province of British Columbia, 2002

Co-published by Small Woodlands Program of BC
and the Canadian Forest Service

Acknowledgements

The *Managing Your Woodland* was revised by the Small Woodlands Program of BC, an initiative of Forest Renewal BC. The program is designed to encourage owners of private forest lands in BC to manage their properties in an economically and environmentally sustainable manner.

The first version of this guide was written by Reid, Collins and Associates Limited under the Canada-BC Forest Resource Development Agreement (FRDA) in 1988. It was reprinted in 1992 under FRDA II. The guide was then updated and revised in 2002 by ECON consulting under the Small Woodlands Program of BC. Funding for final editing and production of the 2002 edition, and creation of the web version was provided by Canadian Forest Service. This work was carried out on behalf of the Small Woodlands Program of BC by TM Communications Inc.

For additional copies of this guide, or more information about the Small Woodlands Program of BC, visit the program web site:

SMALL WOODLANDS PROGRAM OF BC
Email: info@swp.bc.ca, (www.swp.bc.ca)



Natural Resources
Canada

Ressources naturelles
Canada

Canadian Forest
Service

Service canadien
des forêts

Pacific Forestry Centre
506 West Burnside Road
Victoria, BC V8Z 1M5
Phone: (250) 363-0600
Fax: (250) 363-0775

Web: <http://www.pfc.cfs.nrcan.gc.ca>



Web: <http://www.swp.bc.ca>

Disclaimer

Mention in this document of specific commercial products or services does not constitute endorsement of such by the Canadian Forest Service or the Government of Canada.

Medical Warning

This work contains some information on the uses of plants as foods and medicines. Some plant foods can be toxic if the wrong plant part (such as fruit, leaves, stems, or roots) is harvested, or if it is not properly prepared, or if too much is eaten. Some toxic plants look similar to edible plants, and such mistakes can cause serious illness and even death. Never eat a plant if you are not certain of its identity. Learn the appropriate harvesting and preparation methods, and start with a small amount when trying a new plant food.

Descriptions of culinary or medical uses of plants are presented here for informational purposes only. Some medicinal plants can interact with prescription or over-the-counter medications. Medicinal use of herbs should be carried out only under the care of a well informed, qualified physician. Every medicine is a poison if used inappropriately or in the wrong dose. Please note that some herbs mentioned in this book may be poisonous, and others may cause toxic reactions in susceptible individuals. Although most, if not all, culinary herbs are pharmacologically active, for many herbs limited health information is available, and safe levels of consumption are poorly understood.

This document contains information on edible mushrooms. Some species of mushrooms are very toxic, and ingestion of small amounts can cause serious illness or death. Mushroom identification skills require experience based on proper instruction and good field guides. Do not eat any mushroom unless you are an expert or are absolutely sure which species you have.

This document contains information about pesticides. Pesticides must be handled and applied properly according to directions and regulations. Pesticides must be approved by both federal and provincial authorities. Always read the label. The publishers assume no liability arising directly or indirectly from the use of any of the information provided in this document.

Table of Contents

INTRODUCTION

 Introduction	1
What Is This Guide For?	
How Do I Use This Guide?	
Why Small-scale Forestry	
Who Owns The Forests?	
Who Plans And Manages Our Forests?	
Forests And Our Future	
Recommended References	

 Forestry Basics	7
Introduction	
Where Trees Grow	
How Trees Grow	
Family Trees (identification)	
Forests As Collections of Stands	
How Forests Develop	
How Forests Are Classified	
How Forests Are Managed	
Managing For Non-Timber Resources	
Safety In The Woodland	
Recommended References	

FOREST INVENTORY

 Basic Surveying Skills	29
Measuring Direction	
Measuring Distance	
Recommended References	

 Inventory of Woodlands	35
Why Do I Need an Inventory?	
What Is a Forest Inventory?	
Where to Start?	
What Kind of Information Do I Need?	
How Do I Plan My Inventory?	
Measuring Inventory Plots	
Compiling Your Timber Inventory	
Calculating Your Harvest Level	
Recommended References	

MANAGEMENT PLANNING

 Woodland Management Planning	55
Why Is A Management Plan Important?	
What Is Planning?	
What Does a Forest Management Plan Look Like?	
How Do I Develop A Forest Management Plan?	
Sample Forest Management Plan	
Recommended References	

STAND MANAGEMENT

 Silvicultural Systems	71
Silvicultural Systems	
Even-aged Systems	
Uneven-aged Systems	
Systems with Reserves	
Recommended References	

 Commercial Thinning	87
Introduction	
Why Thin?	
When to Thin	
How to Thin	
Thinning Equipment	
Recommended References	

MULTI USE

 Agroforestry Overview	95
What is Agroforestry?	
How Agroforestry Systems Work	
What are Shade Systems?	
What are Sun Systems?	
What are Silvopasture Systems?	
What is Integrated Riparian Management?	
What are Timberbelts?	
Defining an Agroforest	
Benefits of Agroforestry	
Recommended References	

FOREST ACCESS

Woodland Roads **105**

- What Are My Access Needs?
- How Do I Plan A Road Network?
- Road Construction - How Much Can I Do?
- Equipment
- Construction Steps
- How Do I Care For My Roads?
- What Are The Environmental Considerations?
- Sample Road Construction Contract
- Recommended References

HARVESTING

Harvesting the Trees **123**

- Harvesting Is More Than Cutting Trees
- When Do I Harvest?
- How Much Do I Cut?
- Harvesting Steps and Methods
- Small-scale Equipment
- Environmental Considerations
- Scaling Requirements
- What Is a Timber Mark?
- Working with a Logging Contractor
- Sample Harvesting Contract
- Recommended References

MARKETING

Forest Product Overview **149**

- From Woodland to the Marketplace
- How to Identify Timber Products
- Special Products From Your Woodland
- Recommended References

Non-timber Forest Products **165**

- What are NTFPs?
- The Business Potential of NTFPs
- Some Edible Herbs and Wild Vegetables
- Wild Mushrooms
- Wild Berries and Fruits
- Medicinal and Pharmaceutical Plants
- Floral Greenery
- Landscape Products
- Recommended References

Introduction to Certification **177**

- What is Forest Certification?
- Forest Certification Programs
- Recommended References

REFORESTATION

Reforestation Basics **185**

- Introduction
- Site Assessment and Species Selection
- Natural Regeneration
- Preparing the Seedbed
- Artificial Regeneration
- Other Considerations
- Recommended References

STAND TENDING

Stand Tending Basics **201**

- Why Cultivate Your Forest?
- What Is Stand Tending?
- Brush Control
- Spacing and Thinning Treatments
- Stand Management to Maintain Biodiversity
- Fertilizing
- Pruning
- Recommended References:

FOREST PROTECTION







Forest Protection Basics **225**

- Introduction
- Forest Fire
- Insects and Disease
- Forest Insect Pests
- Forest Tree Diseases
- How Do I Protect My Woodland?
- What Else Can Damage My Forests?
- Recommended References

BUSINESS PLANNING

Business Basics **249**

- What Kind of Business Is This?
- What Business Structure Do I Need?
- What Else Do I Need to Organize to Set Up a Business?
- Do I Need A Business Plan?
- What Is A Business Plan?
- Recommended References

 Introduction to Taxation	255	 INFORMATION RESOURCES	
Tax Planning		 Glossary	273
Property Taxes		 Contact Addresses	287
Resource Taxes		Ministry of Forests Contact Addresses	
Sales Taxes		Woodlot Association Contact Addresses	
Income Taxes		Federation of BC Woodlot Associations	
Estate and Succession Tax Planning		Contact Addresses	
Recommended References		Education Institutions	
 FOREST LEGISLATION		Other Ministries	
 Forest Legislation	263	 Conversion Factors	305
What Legislation Applies to My Land?			
Federal Legislation			
Provincial Legislation			
Local Legislation			
Recommended References			



Managing
Your
Woodland

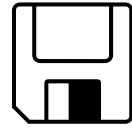

Introduction

Introduction

In this chapter...

Who and What Is This Guide For?	2
How Do I Use This Guide?	2
Why Small-scale Forestry?	3
Who Owns The Forests?	4
Who Plans And Manages Our Forests?	5
Forests And Our Future	5
Recommended References	6

.....

Who and What Is This Guide For?

This guide has been written for non-foresters. Its intent is to make the practice of forestry understandable, rewarding, profitable and fun.

This is a guide for the management of small woodlands in British Columbia for a range of social, economic and environmental values. It will provide you with an overview of the steps involved in the practice of forestry, the types of decisions you will need to make, the kind of work to be done, and where you can get help. It will not tell you everything there is to know about forest management, but it will tell you what you need to know to get started and to take the next steps in managing your woodland.

This woodland guide is designed to:

- answer some of your questions and get you started in managing your woodland
- encourage you to clarify your goals for managing your woodland
- help you find alternative ways of achieving them
- provide directions to where you can get more information, assistance and advice, and to stimulate further interest in small-scale forestry in British Columbia.
- give you an overview of the policies and regulations that govern forestry practices in BC and help you through the basic management phases.

How Do I Use This Guide?

This guide deals with the process of sustainably managing a small private forest property primarily for timber production but with consideration given to the safeguarding or enhancement of other resource values. Each chapter deals with a management phase in woodland management. Together, they provide you with the information needed to develop a Forest Management Plan for your woodland. For specific management techniques for non-timber resources such as fisheries, wildlife or recreation, you will be referred to other handbooks and source materials. The chapters can also be used independently for training exercises or as handouts. Most chapters are structured in two parts. They begin with a discussion of the ‘whats and whys’ of the particular subject, such as a forest inventory, and end with more specific information on ‘how to go about it’ depending on the type of woodland operations you have in mind.

The chapter on “Forestry Basics” introduces you to how trees grow, how forests develop over time, and how they are managed in British Columbia. Forest and woodland classification systems are outlined, along with the concepts of sustainable forest management.

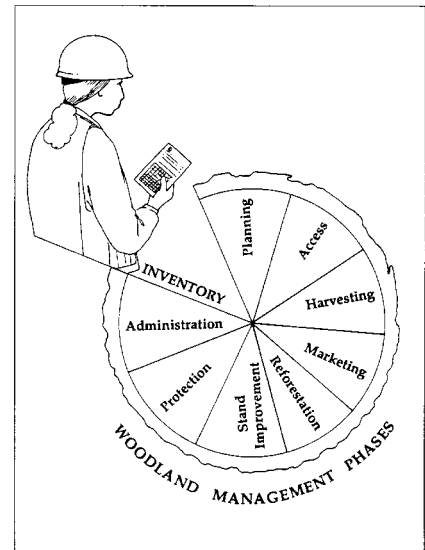

The chapter on “Woodland Management Planning” walks you through the steps of developing a Forest Management Plan, and provides a simple plan outline for your reference.

The remaining chapters provide the ‘what, why and how’ of each of the management phases that make up the Forest Management Plan. In addition, you will find information on where to get information and technical assistance; and what legislation applies to private woodland owners in BC, your forest products and tax requirements.

At the end of each chapter you will find a ‘Recommended References’ section to publications, web sites, Small Woodlands library collection and other programs. Under the chapter ‘Information Resources’ you will find some helpful government and non-governmental organisations addresses, glossary and conversation tables.

Forest management is an ongoing process. Each of you will enter this process at different places in the management cycle, and with different needs whether you have a mature crop of trees or a bare piece of land. You should begin with a review of your forest inventory, since it will tell you what you will be managing. This will help you to determine the appropriate phase (and chapter) at which to start developing your Forest Management Plan (such as reforestation, stand tending, harvesting). Keep in mind that each phase builds on decisions made in the phases preceding it, and though you may start your planning at the harvesting phase, you will be making choices that affect the reforestation and stand tending phases of the next crop.

Why Small-scale Forestry?

Forestry is a big industry in BC. It is the province’s number one resource, employer of 20% of the provincial labour force, and generator of over one quarter of our provincial revenue, primarily generated from large-scale forest operations.

So where does small-scale forestry fit in British Columbia? Is it hobby tree-farming or lifestyle and viable business? What are the opportunities and what are the rewards?



Sixty million hectares or 64% of BC’s 95 million hectare land area is covered in forest. About 42% of this forest land is currently classified by the Ministry of Forests as being productive, accessible and covered in tree species suited to commercial timber production. An additional 13% of the province is protected through a system of parks and protected areas. In area, the small-scale forest land category (including small, scattered parcels of Crown land, Indian Reserves,

and private lands) covers only 8% of the provincial forest land base. But in a province the size of BC that represents a lot of forest, approximately 4 million hectares. With a conservative, generalized provincial average of 35 cubic metres of timber produced per hectare of forest land at maturity age, these ‘small-scale’ lands can contribute a

considerable volume of wood to the provincial timber supply. Using an arbitrary average parcel size of 200 hectares for these small woodland holdings, approximately 20 000 people, or 1% of the province's citizens, could become involved in small-scale woodland management.

Small-scale forestry provides an entry into the science and business of forestry to people with diverse interests and backgrounds. It encourages experimentation with different forest management strategies, methods, and equipment in an environment that can be closely monitored.

To the province then, and the provincial economy, small-scale forestry operations could be a significant source of employment and timber production, and contribute to community stability. To the owners and operators of these lands, it means even more.

Small-scale forestry brings people into closer touch with their environment and their values. For some it is a secondary income, for most a lifestyle. Land stewardship and the production of non-timber resources are the goals of many small-scale woodland operators.

Who Owns The Forests?

The majority (94%) of BC's forest land is owned by the provincial Crown (that's you and me) and rights to its timber and other resources are made available to users through a system of land tenure, or licencing agreements. Some tenures, such as Tree Farm Licences and Woodlot Licences, require the licensee to reforest areas after harvesting while others simply transfer to the licensee the rights to harvest timber. A few 'special use' tenures provide permits for individuals to cut firewood, collect scientific specimens, and produce Christmas trees or carry out other, small-area activities on Crown land. Approximately 1% of the forest land base is regulated by the federal Crown; these forest lands include the national parks, lands associated with the Department of National Defence, and Indian Reserves. Another 5% of the provincial forest is owned privately. Together, these lands have considerable potential for forest management which presents an opportunity to increase future timber supply, land values, personal incomes and employment in the province.

Who Plans and Manages Our Forests?

Due to the diverse nature of BC forests, forest land use planning is often a complicated process, involving governments, associations, corporations and the general public. Since most of the forest land is held by the Crown, the provincial government agencies take the lead role in the planning process.

There are also a number of non-government and private organizations that play a role in forest management.

The federal government, through the Canadian Forest Service, provides scientific and technical leadership in research programs covering forest protection, growth, renewal and forest development.

Most commercial forestry production is carried out by a small number of large, integrated forest companies. The term integrated refers to the fact that they both produce logs and manufacture them into lumber, pulp and other wood products. In this way, forestry is practiced as a partnership; regulated by the provincial government and carried out by the private sector.

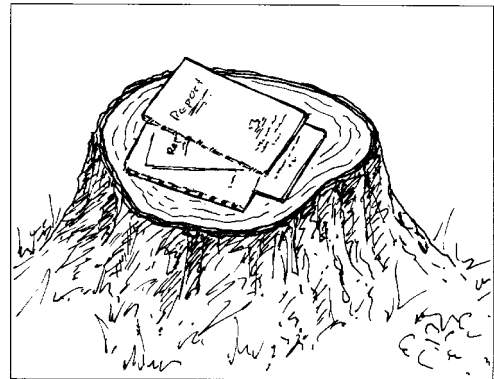

In addition to the large forest companies, there are opportunities for others to become involved in the practice of forestry through the provincial Timber Sale program, as woodlot licensees, as First Nation communities, as communities or as private owners of forest land. These are the small-scale forest users for whom this guide is written.

Forests and Our Future

Directly, as owners or licensees, and indirectly, as voters, each of us in British Columbia is a woodland manager. We have a responsibility to understand what forestry is all about in order to make informed decisions regarding the use and management of our provincial forest lands.

The first edition (1988) of this guide was produced with the benefit of considerable input from many of the intended users. In 2002, the Small Woodlands Program of BC decided to update the Guide, as it became one of the most used and known books for small woodland owners in BC.

Recommended References

Small Woodlands Program of BC

A comprehensive 'Small Woodlands Library' is available on the web [www.swp.bc.ca]

Small Woodlands Program of BC

Small Woodlands Business Planning and Marketing Guidebook, March 2002

[www.swp.bc.ca]

Woodlot Licence Program

[www.for.gov.bc.ca/rte/woodlots/woodlot-program.htm]

Canadian Forest Service

Pacific Forestry Centre

506 West Burnside Road

Victoria, BC, V8Z 1M5, tel.: 250-363-0600, fax: 250-363-0775

[www.pfc.cfs.nrcan.gc.ca]

Publications on many forestry-related topics are available on request from the on-line bookstore at [<http://bookstore.cfs.nrcan.gc.ca>]

Ministry of Forests

Resource Tenure and Engineering Branch

[www.for.gov.bc.ca]

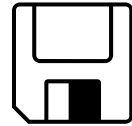

Forestry Basics

Introduction

In this chapter...

Introduction	8
Where Trees Grow	8
How Trees Grow	10
Family Trees (Identification)	13
Forests As Collections of Stands	16
How Forests Develop	17
How Forests Are Classified	20
How Forests Are Managed	21
Managing For Non-Timber Resources	22
Safety In The Woodland	24
Recommended References	26

.....

Introduction

The word ‘forest’ brings a host of images to mind—trees, birds, animals and activities such as fishing, photography, camping, cutting firewood and more. Forests are systems that offer a variety of products and special experiences. As a result, there is a lot to know about them.

This chapter will introduce some forestry basics such as the importance of forest soils, how trees grow, how forests develop, and how they are classified and managed for timber production and other resources. You will find other helpful information in the section ‘Information Resources,’ including a glossary, conversion tables, helpful organizations and addresses, and tree volume tables.

Where Trees Grow

Soils are the single most important element of a forest that will determine what type of forest can grow as well as influence how you will be able to access your forest. Therefore, soils are an important consideration to the woodland manager.

Soil is the natural occurring unconsolidated mineral or organic material at the surface of the earth, which is capable of supporting plant growth. A particular type of soil is a result of topography, geological processes and parent material. Its properties usually vary over time and with depth and are a result of climate, especially moisture and temperature, and organisms.

Three major factors influence soil quality: depth, moisture and nutrient regime. Other than soil depth, the moisture and nutrient regime cannot be measured directly in the forest, but need to be interpreted through indicators such as soil drainage, organic material and soil texture. If you can identify these and understand how the various soil properties influence tree growth and soil behaviour, you will have made a good start towards assessing the potential of your forest site and planning for its use.

Soil Drainage

In well-drained soils, excess water drains away steadily, but not rapidly. Often the soil will be dusty red or brown from iron compounds and humus, the organic matter of decomposing leaves and branches. Plant growth is good in well-drained soils, and roots (if they can be seen) will be well developed. In poorly-drained soils, the roots are often

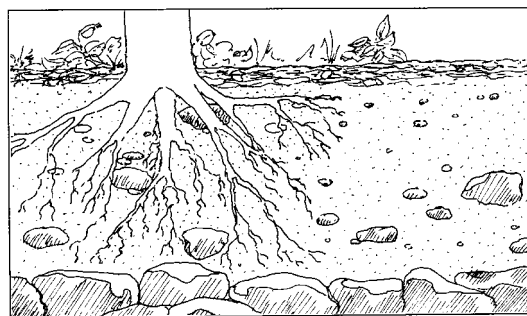

waterlogged and root systems will be shallow and stunted. Trees on these soils will be susceptible to windthrow, possibly precluding the prescription of a partial harvest or thinning management system. At the other extreme, very dry, often rocky, fast-draining soils will be low on nutrients, leach out nutrients quickly and, therefore, result in poor tree growth.

Organic Material

The amount of leaf, needle and branch litter on the surface of the soil indicates how quickly decomposition is taking place and as a result how quickly nutrients are being released back into the soil. More than 10 cm of organic material, as can often be found on swampy sites, indicates that tree growth will be slow. Some of our forest management operations will influence the rate of soil decomposition. Removal of the forest canopy by clearcutting or heavy partial harvesting will increase the amount of solar radiation reaching the forest floor. Likewise, the humidity level will also be altered. Temperature, moisture and pH-level are primary determinants to the rate of decomposition.

Soil Texture

The texture of the soil beneath the organic layer depends on the size of the soil particles. Sand has the largest particle size, followed by silt and then clay. Sand is gritty; silt is floury when dry and slightly gritty, almost soapy when wet; while clay is very fine and floury when dry and very sticky when wet. Generally speaking, sandy or gravelly soils are most suited to pines and Douglas-fir, whereas soils with sand and silt are favoured by the true firs (amabilis, grand, sub-alpine —often referred to as ‘balsam’) and the cedars.

Silty soils with some clay provide a good base for spruce, while hemlock enjoys well-drained soils with a top layer of organic material. Most tree species are tolerant of a wide range of soil types.

Soil stability on slopes is greatly influenced by the presence of tree and other plant roots that help to hold it in place and drain it of water. Major site disturbances, such as extensive road building and clearcutting which remove this natural support and drainage system must provide compensating drainage structures, such as culverts and ditches to protect exposed soil. Roots, insects and small animals create pores in the soil in which air and water are

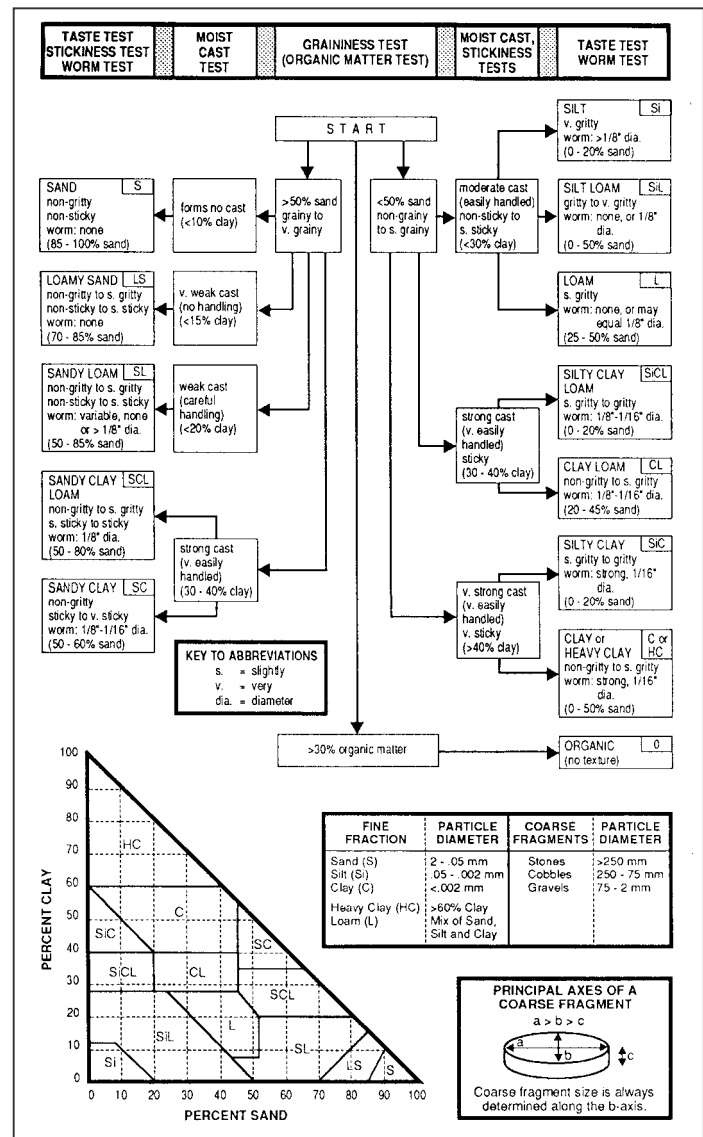

held. When these are greatly reduced or removed, as happens under heavy equipment traffic, the soil becomes more dense and compacted. Soil compaction reduces drainage, hampers seedling establishment and slows down tree growth. It can lead to problems of excess surface run-off which may in turn cause instability and soil erosion.

Recognizing the capabilities (and limitations) of the soils on your woodland, and organizing forestry operations to minimize problems will be an important task in the development of your Forest Management Plan. Various harvesting methods and equipment options, as well as seasonal considerations are discussed in the chapter “Harvesting The Trees.”

How Trees Grow

Trees, like people, grow upward and outward as they mature. Each year, a tree adds new growth at the tips of its branches and the top of its crown. Like dipping a candle in wax, each year, a new layer of wood cells is added to the outer edge of the tree, just beneath the bark. Growth is generally fastest in the early years of a tree’s life, and slows down as the tree reaches maturity.

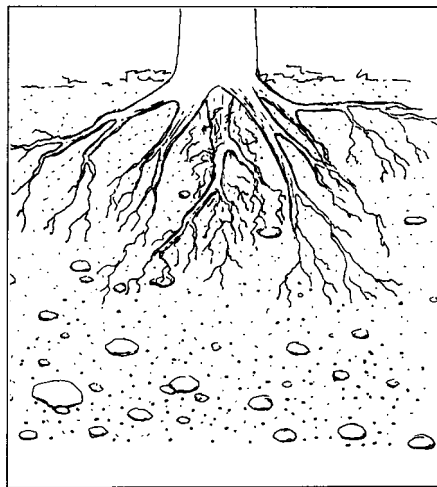

There are three major parts to a tree, each of which serve a different function. The roots provide anchorage and support and absorb moisture, minerals and nutrients. The crown manufactures the food to fuel growth, and the trunk provides mechanical support for the crown and acts as a pipeline for water and sap. Though the roots of most coniferous species do not grow deep into the earth like the taproot of a carrot, they form extensive systems that increase in size and length each year. In general, the roots of a mature tree spread out in area about the same distance as the tree’s crown. Individual roots have been known to reach three to four times the tree’s height. As the roots branch out in search of

water, they subdivide into finer and finer roots. At their tips, an army of single-celled root hairs act like sponges absorbing water and dissolved nutrients.

From the roots, the water travels into the tree’s water pipeline, the ‘*xylem*’ cells, and is transported up into the trunk and distributed throughout the tree. Water drawn into the leaves is used by the tree in the production of food, through a process called *photosynthesis*, that takes place in the green cells of the tree’s leaves. The cells are green due to the presence of *chlorophyll*, a pigment that captures sunlight energy. Fuelled by the energy of the sun, the tree manufactures carbon dioxide and water into sugar, releasing oxygen as a by-product. The sugar produced in this process moves from the leaves into the branches and down to other parts of the tree through a separate food pipeline called the *phloem*. The larger the surface area of the crown and the more leaves or needles on the tree, the greater its food-producing capability.

In addition to housing the tree’s food manufacturing factories, the leaves and crown of the tree serve other important functions. On the undersides of the leaves, or needles, are the tree’s breathing apparatus, the *stomata*. Each stomata is an aperture, ringed by special

cells that act like lips, opening to admit air and closing to prevent moisture loss. The crown also serves to shade the tree and the forest around it. As a result, trees and forest stands create their own *microclimates* within a forest (walk into a stand of trees from a road or other open area on a hot day and feel the difference in temperature).

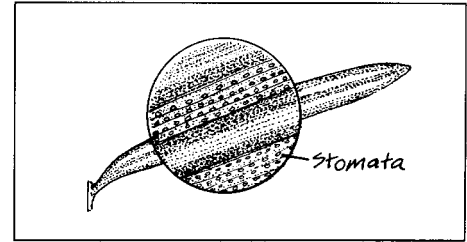

Looking at the inside of a tree, we can see a series of circles within circles. These are the annual growth rings of the tree. In the spring of each year the tree creates new cells in a special area, called the *cambium*, just inside the bark of the tree. This single row of cells encases the tree in a sheath from its roots to its branch tips, and has the amazing capacity of growing in two directions at the same time.

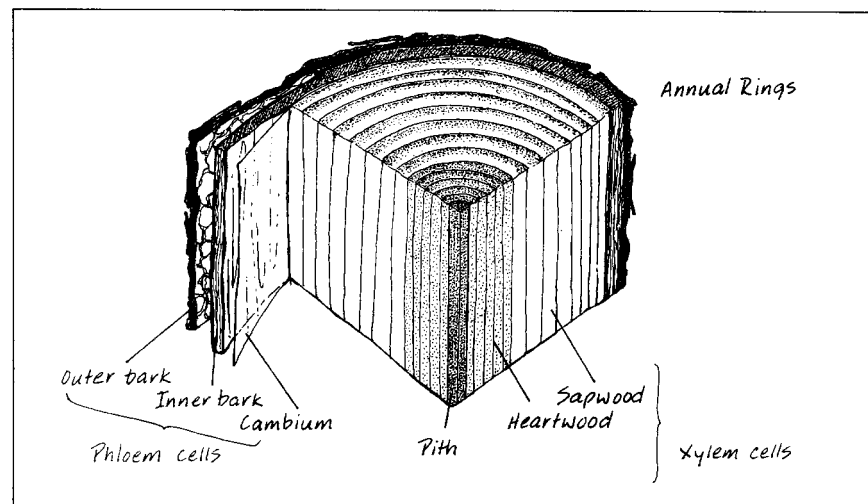

Cells which grow towards the bark are the *inner bark* phloem cells which carry the tree's sap and sugars. As they are pushed outwards by new cells, they gradually thicken and die and become part of the tree's 'outer bark.' The bark acts as a protective skin to the tree in much the same way that our skin (also composed of dead cells) protects us. Bark protects the tree from physical or mechanical injury, insects or disease, and ground fires. The cells which the cambium produces on its inside edge, form the xylem or waterway of the tree, known as the *sapwood*. As the tree grows in diameter, the innermost cells of the sapwood lose moisture and become clogged with resins, oils and gums, and this portion of the sapwood becomes the *heartwood*. The xylem cells, both the living sapwood and dead heartwood, form a kind of skeleton that provides mechanical support to the tree. This skeleton is what we know and love as wood. At the centre lies a soft, pulpy core known as the *pith* which marks the oldest part of the tree.

Each growth ring represents one year in the tree's life, and it is possible to interpret the tree's life history by reading these rings. The width of the ring tells us something of the tree's growing conditions that year—how much light, water, and nutrients were available, and whether there might have been other plants competing for these resources. The supply of light, water and soil nutrients determines the rate at which the tree grows. Trees growing in rich, moist soil environments grow faster than those on poorer, drier sites. A series of narrow growth rings often indicates that the tree was under severe competition

or shading from other plants or trees. One or two narrow rings could suggest a year or two of drought or of insect attack that reduced the number of needles and therefore the amount of food produced. Severe frost can create 'frost rings' which is a distortion of normal xylem cells.

Other events, such as fire or injuries can also leave their marks. The following illustrations tell another story. When a tree has been dislodged from its upright position, its annual growth rings compensate over the next few years to correct the lean and bring the tree back to its vertical position. The diagram on the left shows *compression* rings that develop in conifer species as the tree grows to effectively *push* itself upright. The diagram on the right shows the *tension* rings that deciduous trees produce in order to *pull* themselves upright.

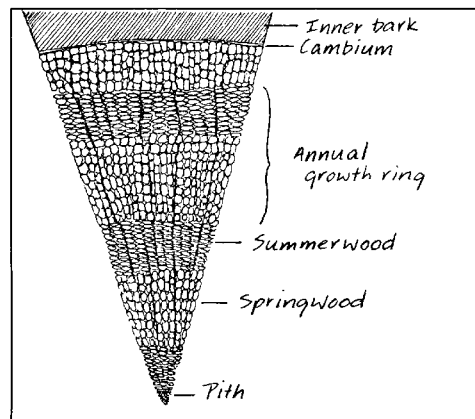
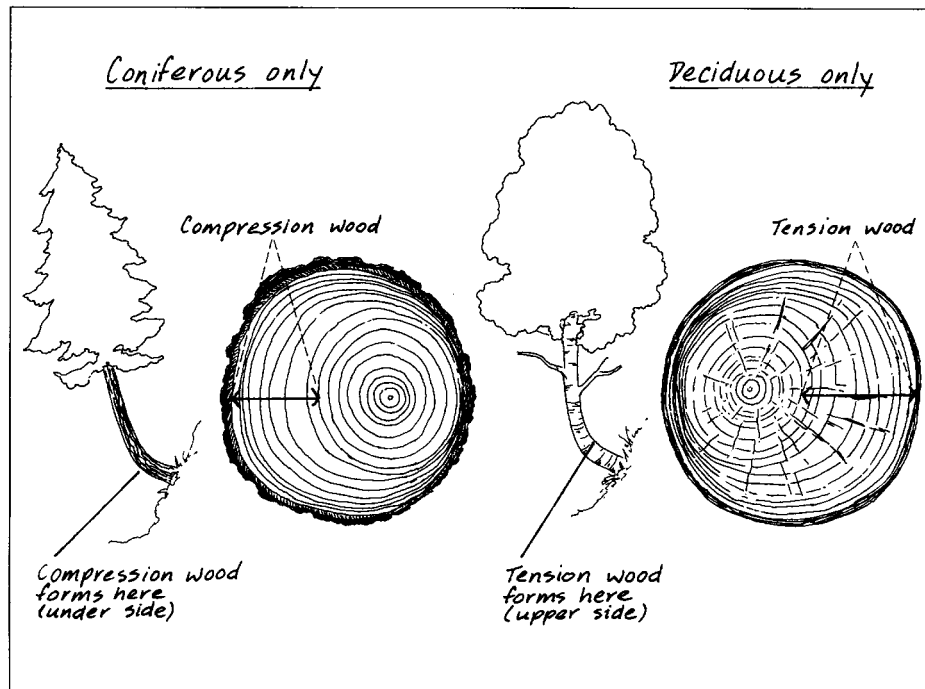

The annual growth ring is made up of two bands of cells, those formed early in the growing season and those formed at the end of the season as the tree is slowing down to prepare for its winter dormant period. The *spring-wood* cells develop early in the growing season when water is plentiful. Growth is rapid and the cells created are large and have relatively thin walls. The later *summer-wood* cells develop under less favourable conditions; growth is slower and the cells are smaller and thicker-walled. The thicker-walled summerwood cells are stronger than their thin-

walled springwood companions. So in comparing two pieces of lumber, the one with the greater proportion of summerwood will be the stronger, all else being equal.

Family Trees (Identification)

Like the rest of us, trees have families, too. They have parents and siblings who they resemble, family traits that they exhibit and, depending on their birthplace, prefer some environments over others. Trees even have family names - the pines, the firs, spruces, hemlocks, oaks, maples, birches and *arbor-vitae*, to name a few. Trees have common names (Douglas-fir), and formal (Latin) names (*Pseudotsuga menziesii*). These scientific names may appear confusing at first, but they may actually describe the tree and some of its history. In the case of Douglas-fir (named for David **Douglas**, a Scottish botanist and explorer in the early 1800s), the first part of the Latin name, *Pseudotsuga*, translates into 'false hemlock' (because the needles are similar), while the second part, *menziesii*, honours Archibald Menzies, the surgeon and naturalist for Captain George Vancouver during his pacific expedition of 1790–95 aboard the Discovery. Tree classification systems have been developed to help you identify individual trees on the basis of their family and individual characteristics.

Tree classification systems begin by separating trees into two groups, based on whether the trees keep their leaves year-round, or shed them before winter. The evergreens, or conifers, keep their leaves for two years or longer; the broadleaved, or deciduous trees keep their leaves for only one season before being shed. In North America, we often substitute conifer with softwood, and deciduous with hardwood although some conifer woods can be very hard and some deciduous wood very soft. Other differences between the two groups include:

Conifer

- leaves are needle or scale-like
- many needle-like seed leaves (bracts)
- seeds develop in cones
- wood is mostly soft and resinous.

Deciduous

- leaves are broad
- two broad seed leaves (bracts)
- seeds develop in flowers
- wood is mostly hard and non-resinous.

Exceptions to the Rule

- *Western yew* is an evergreen that bears its seeds singly, inside a small red berry, instead of a cone. Note that its needles are poisonous to horses and cattle, especially when cut and piled to rot.
- *Larch* is a conifer that is not evergreen; watch its needles next fall.
- *Arbutus* is a broadleaf evergreen that sheds its bark instead of its leaves.
- And yes, some softwoods are harder than their hardwood cousins.
- *Red alder* is a deciduous leaf-bearing tree which bears its seeds in a cone.

Tree identification is often based on the shape, size, texture and colour of each species' leaves, cones and bark. Tree silhouettes can also be used for identification. Since trees are a major life-form in your woodland, and most of your forest management practices will be developed based on the species composition and age of your trees, you need to become familiar with the appearances, names and characteristics of species and family groups. These characteristics are called *silvics*, the amazing interaction of a tree species with its environment and heredity. Some silvicultural attributes are tolerance to shade, seedbed requirements, resistance to fire and drought resistance.

In British Columbia, the conifers are the major commercial tree group and eight families have most of the industrial favourites within them. Another four deciduous families contain most of the species commonly encountered in forest land operations. You can begin to sort out the family trees on your woodland by looking at their branches and leaves and where they grow and what other plants are associated with them. The list of species you are most likely to encounter, along with some clues for their identification, their common and formal (scientific) names, family (genus) symbol, and species symbol, is found on the following table.

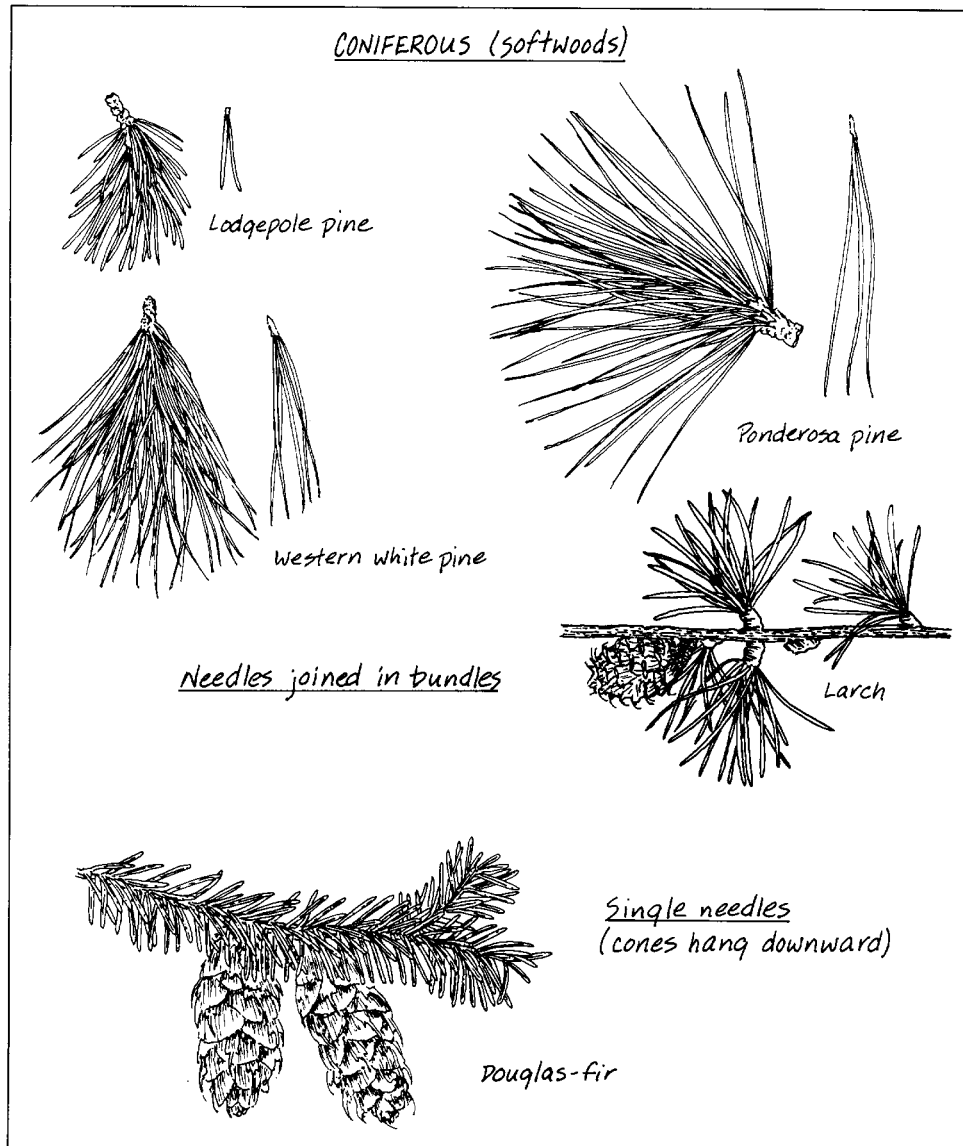

Trees of British Columbia

What to look for	Common name	Scientific name	Family symbol	Species symbol
Conifers (softwoods)				
Scaly needle-like leaves	Western red cedar	<i>Thuja plicata</i>	C	Cw
	Yellow cedar (cypress)	<i>Chamaecyparis nootkatensis</i>	Y	Yc
Needles joined in bundles	Lodgepole pine	<i>Pinus contorta</i>	P	Pl
	Ponderosa (yellow) pine	<i>Pinus ponderosa</i>	P	Py
	Western white pine	<i>Pinus monticola</i>	P	Pw
	Alpine larch	<i>Larix lyallii</i>	L	La
	Tamarack	<i>Larix laricina</i>	L	Lt
	Western larch	<i>Larix occidentalis</i>	L	Lw
Single needles cones hang downward)	Douglas-fir	<i>Pseudotsuga menziesii</i>	F	Fd
	Mountain hemlock	<i>Tsuga mertensiana</i>	H	Hm
	Western hemlock	<i>Tsuga heterophylla</i>	H	Hw
	Black spruce	<i>Picea mariana</i>	S	Sb
	Engelmann spruce	<i>Picea engelmannii</i>	S	Se
	Sitka spruce	<i>Picea sitchensis</i>	S	Ss
	White spruce	<i>Picea glauca</i>	S	Sw
Single needles (cones are upright)	Alpine fir (balsam)	<i>Abies lasiocarpa</i>	B	Bl
	Amabilis fir (balsam)	<i>Abies amabilis</i>	B	Ba
	Grand fir (balsam)	<i>Abies grandis</i>	B	Bg
Deciduous (hardwoods)				
Leaves with coarse lobes	Broadleaf Maple	<i>Acer macrophyllum</i>	M	Mb
Finely toothed leaves	Trembling aspen	<i>Populus tremuloides</i>	A	At
	Black cottonwood	<i>Populus trichocarpa</i>	A	Ac
	Balsam poplar	<i>Populus balsamifera</i>	A	Ac
Coarsely toothed leaves	Red alder	<i>Alnus rubra</i>	D	Dr
	White birch	<i>Betula papyrifera</i>	E	Ep
Other favourites...	Western yew	<i>Taxus brevifolia</i>	T	Tw
	Dogwood	<i>Cornus nuttallii</i>	G	Gp
	Arbutus	<i>Arbutus menziesii</i>	R	Ra

Forests As Collections of Stands

The basic management unit of a forest is a *stand*, or community of trees with common characteristics. Each stand represents a set of relationships between the soil, water, plants, animals, insects, birds and other life-forms that live together. Stands are like the ethnic and cultural groups that make up a society. Each is distinguishable and on the basis of its membership we are able to make some generalizations about its needs and behaviour. In forestry, these generalizations relate to how the trees grow and how they will react to different management practices. Such forecasts are important to the process of planning, since they help us choose a management system suited to the particular species and age class structure of a stand.

As a forest develops naturally, its stands follow a growth cycle of a number of steps from establishment to maturity, through death and re-establishment. Individual trees and even parts of the stand will die and new forms of vegetation will appear and grow in the openings created. Forests may be separated into two broad classes based on the degree to which the trees are 'in step' as they grow, that is, whether or not the trees grow old as a group, or as individuals at different stages in the growth cycle.

Even-aged stands are those in which the growth cycle is generally in-phase. Usually, one species will dominate. Trees are of the same general age class (within 10 to 20 years), and the same general height. Even-aged stands, as a result, tend to look flat on top. Despite similarities in age, even-aged stands can display a range of diameter classes, so even-aged status should not be determined simply on the range of diameters. Even-aged forests, both coniferous and deciduous, predominate in the northern hemisphere following large-scale disturbances such as fire, wind or logging. Even-aged stands are usually composed of shade-intolerant species: alder, cottonwood, Douglas-fir, lodgepole pine and ponderosa pine.

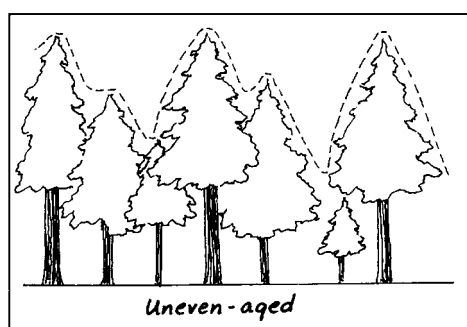
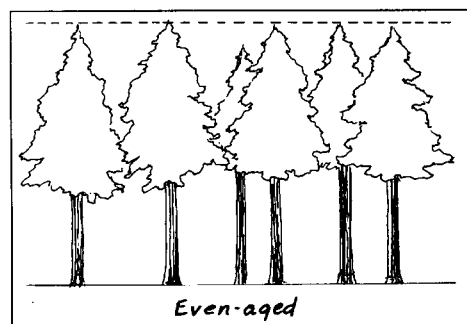

Uneven-aged stands are composed of trees with at least three age classes, and often many species, sun-loving and shade tolerant alike. Trees mature, grow old and die according to individual timetables influenced by species and environmental factors. Young trees, that can grow in the shade of other trees, will grow up to replace the older trees. Uneven-aged stands appear ragged on top, exhibit a variety of slopes and sizes of trees, different kinds of foliage, and many shades of green.

Stands are managed differently, depending on whether they are uneven or even-aged. The silviculture and reforestation systems for both types of forest are discussed in later chapters "Harvesting the Trees," "Reforestation Basics," and "Stand Tending Basics."

How Forests Develop

Uninterrupted, a forest expresses itself in different stages as it grows and develops. The process of development is called *succession*. There are two distinct types of *succession*: seral and zonal. *Seral* is the development of a forest over TIME, whereas *zonal* denotes forest change over SPACE.

Depending on water and soil conditions, a forest progresses through four or five distinct phases. We recognize and identify these stages by the dominant species of plant life. Though these growth stages take place over too long a period to follow in one forest, we can often see them expressed in different forests in a region. The timetable of forest succession varies for different forest environments and with changes in climate and landscape.

As it develops, a forest will move towards a state of stability. This stage is characterized by a dominant tree species that can reproduce indefinitely in its own shade. When a forest reaches this point it is known as a **climax** forest. In this state the rate of change is very slow and the climax species will remain dominant until environmental conditions change or there is a catastrophic event such as fire, wind, flood or logging. The climax species will depend on the site and location of the forest. For example, cedar and hemlock are climax species on the coast and in the interior of the province, for the sites on which they occur. White spruce and balsam are climax species in the interior high elevation sites, and black spruce is a climax species for many northern swampy sites.

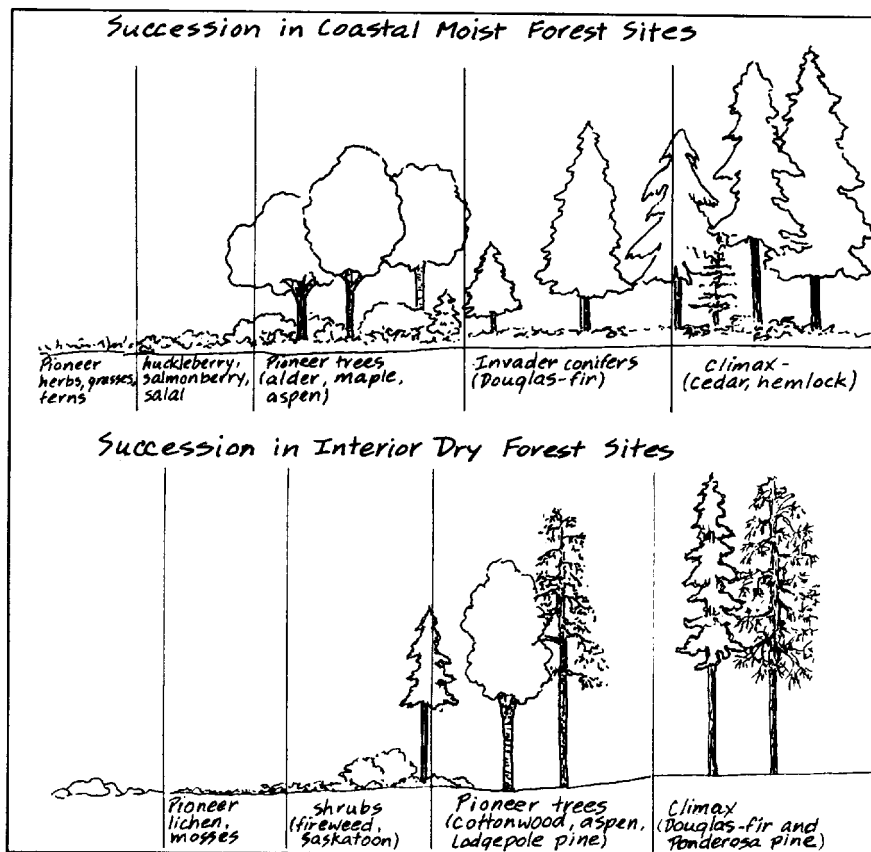

The process of natural forest development (i.e., seral succession), begins with bare ground, when the trees and other vegetation have been removed by fire, logging, landslides, glaciers or similar clearing events. *Pioneer species* such as herbs, grasses, moss or ferns are the first species to green up the area. These plants are short-lived, and as they die they provide nutrients and organic material to enrich the soil and help hold moisture for the plants that follow.

Soon afterwards, another distinct form of plant life begins to dominate the area. Woody-stemmed plants such as huckleberry, salmonberry and salal are found on the coast; and fireweed, saskatoon, thimbleberry and twinberry appear in the interior. As these species populate a site, their roots help bind the soil and protect it from erosion, while their branches and leaves provide windbreaks and shade for smaller plants on the ground. These larger plants also provide food, shelter, and habitat for small mammals such as mice and squirrels whose fecal pellets contain bacteria and yeasts which re-inoculate the soil on degraded sites.

Within a decade, *pioneer tree species* may begin to take over the site. On the coast, species such as alder, maple and aspen are pioneer species; in the interior, pioneer species of cottonwood, aspen, birch, lodgepole pine and interior Douglas-fir predominate. The roots of these pioneer trees further stabilize the soil and help break up underlying rock as they grow down in search of water. Some roots die, leaving hollow tunnels which allow water and air to penetrate deeper into the lower soil horizons. This, in turn, permits more rapid weathering of the parent material, releasing mineral nutrients to the plants above.

The pioneer species can dominate for 50 to 100 years, as *invasive conifers*, growing slowly up through the shade of the pioneer tree species, begin to appear. Balsam (grand fir, amabilis fir), pines (white pine, ponderosa pine), and coastal Douglas-fir slowly take their place in the sunlight, eventually overtopping and outliving the pioneers. This stage in the development of a forest can last for up to 500 years.

Though it is often hard to detect, the forest continues to develop, and if growth is not interrupted by man or nature, eventually a *climax species* will become established. Unless the environmental conditions change, the only thing that gets the better of these trees at this point is old age. Though individuals die, the species continue to dominate the forest landscape as new seedlings develop under the shade of the trees that seeded them.

Zonal succession is the adaptation of a forest across the landscape. An example would be the different forests found as one travels from sea-level to a mountaintop on the coast. You could travel through the coastal Douglas-fir zone, the coastal western hemlock zone, the mountain hemlock zone, then topping out at the alpine tundra zone. Similarly, in the interior, traveling from a valley bottom up through secondary watersheds to again arrive at the alpine.

TOFINO to CRANBROOK

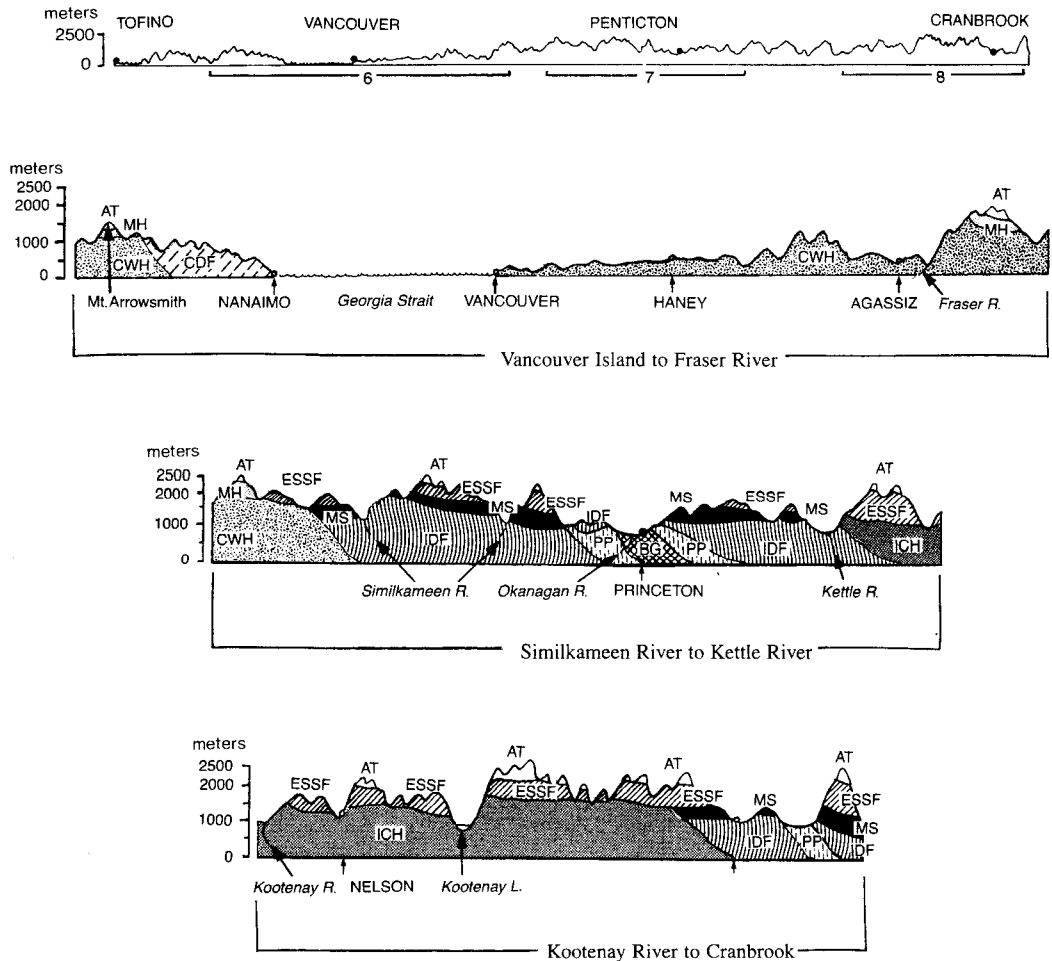

Biogeoclimatic Zones

AT	Alpine Tundra
BG	Bunchgrass
CDF	Coastal Douglas-fir
CWH	Coastal Western Hemlock
ESSF	Engelmann Spruce — Subalpine Fir
ICH	Interior Cedar — Hemlock
IDF	Interior Douglas-fir
MH	Mountain Hemlock
MS	Montane Spruce
PP	Ponderosa Pine

Nature keeps forests in various stages of succession by interrupting the process with outbreaks of insects, disease and fire. People, likewise, disrupt succession through harvesting and other management techniques. In some cases, we manipulate forests to keep them at a particular stage of succession because we value the products that are produced by stands at this stage.

The knowledge of forest succession provides insight to management decisions. Activities such as harvesting change the conditions within a stand or forest and influence the species that can regenerate on the area. When a forest is cleared, it often takes a step backward to an earlier stage in the succession process, though not necessarily to the

beginning. For instance, on the coast, if a stand of hemlock is clearcut, the area may move back to an earlier seral stage. Alder may dominate as a result of soil exposure. This process can be short-circuited by planting the area with preferred species (like Douglas-fir), suited to the cleared condition.

How Forests Are Classified

Based on our knowledge of how forests grow and develop, we devise different management techniques to meet our needs. Managing a forest must take into account a number of factors including owner objectives, the land base, its elevation, soil, water and other resources. We have developed classification systems to help sort through all this information in order to:

- determine the best management system for a particular forest
- identify those sites where we should focus our most intensive management efforts to obtain the best results
- decide which treatments are appropriate to particular stands at a given point in time.

For instance, the forestland base can be described according to its ability to produce commercial wood in a set period of time. Such a system that rates forest sites with a productivity index (site index), is useful in setting priorities for forest management activities. Forests are also classified according to their growing stock—the species, age class, height, number of trees per hectare (stocking), and extent to which they occupy a forest site (crown closure). This is the kind of inventory information found on forest cover maps (see the chapter “Basic Inventory of Woodlands”). In addition to looking at individual characteristics such as species and site, it is also important to look at forest systems.

Ecology is the science of relationships between organisms and their environments. The ecological classification of forest lands makes it possible to predict preferred species tree growth, as well as the potential impacts of activities such as harvesting or site preparation on the forest system. Such classification helps resource managers to prescribe appropriate management treatments for species growing under a variety of environmental conditions.

Of the 31 different coniferous tree species that grow in Canada, 23 grow commercially in British Columbia. These include pines, larches, spruces, hemlocks, Douglas-fir, true firs, cedars, junipers, cypress and yew. An ecological classification system has been developed to help sort out the variety of forest environments in which these grow, and to provide a framework for planning forest management in the province. The classification system is based on differences in vegetation (bio), soil (geo), and climate (climatic). There are 13 zones in this biogeoclimatic ecosystem classification system. Most of the zones are named for one or more of the dominant shade tolerant tree species they support (e.g., interior cedar hemlock zone). They can be further defined by subzones and plant associations. An example of typical forest site in the Kamloops Forest Region is:

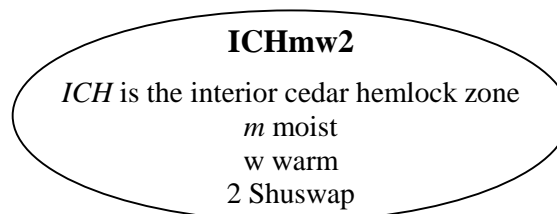

Plants grow in associations with other plants according to the environmental conditions that exist. This association ‘profile’ (type of plant mix), in conjunction with the soil properties can be used to identify site characteristics such as soil moisture and nutrients.

The value of the system lies in the framework it provides for the collection and classification of information that affects resource management strategies. The Ministry of Forests has produced a variety of information to help field people recognize ecosystem units on the ground, and develop management schemes for the treatment of these areas. guidelines and Forest Practices Code guidebooks have been established for harvesting, reforestation and stand tending systems. These materials are a good starting point for woodland operators when planning the management strategy for their woodlands. For more information, contact your local woodlot association, your local Ministry of Forests office, or search the internet

How Forests Are Managed

Forest management involves a continuous cycle of activity. As forests are cleared by human and natural forces, they are re-established by natural seeding or planting. The new stands are tended to enhance their growth rate and improve their quality. Silviculture systems are designed to extract one crop while preparing the site and seedbed for the next. Throughout the cycle, the forests are monitored and protected against insects, fire and disease.

Forestry in British Columbia has developed around the principle of *sustained yield* which is the practice of harvesting timber at a rate that is equal or less than the annual growth of the operable forest. The pre-requisite to determining a sustainable harvest rate or allowable annual cut (AAC) is an inventory of the timber as well as growth models that can forecast its growth. After consideration of any limitation to forest management, such as reserves and non-productive areas, a sustainable harvest rate is calculated and consequently an AAC set that recognise specific objectives of the forest land manager.

While the *sustained yield* principle still acts as a baseline for timber management in the province, a new broader concept called sustainable forest management (SFM) is emerging to replace the narrower focus of sustained yield. Under SFM, forest management strives to manage and sustain the full range of social economic and environmental values inherent in a forest.

The growing and tending of forests is called *silviculture*—‘silvi’ for trees and ‘culture’ for cultivation. Basic silviculture activities include surveys (to assess naturally regenerated and planted areas), planting and brushing.

You will improve the growth and value of immature forests through treatments such as conifer release, spacing, thinning, pruning and fertilization. These activities are discussed more fully in the chapter “Stand Tending Basics.”

But forest management is more than timber production. For the management of non-timber resources one must know first what resource values are present and how the

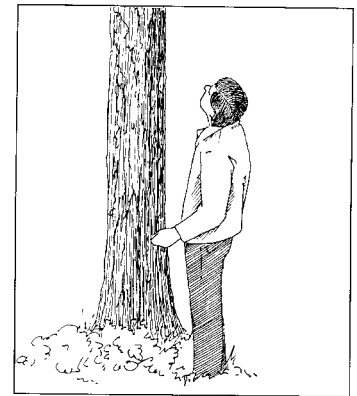

management of each will impact on the others. Compatible uses may be conducted in the same area at the same time, or in the same area at different points in time (i.e., a rotation of uses). The standards set in the Forest Practices Code (FPC) guidebook series are developed to minimize the environmental and social impacts of timber management. Although private woodland owners not required to follow the FPC guidebooks, these standards make good sense on your woodland also.

Managing For Non-timber Resources

For the small-scale woodland operator, aesthetics, recreation, range, wildlife and non-timber products will likely be the major non-timber interests.

Recreation values may include the topographical, biological and cultural features that you wish to protect and develop on your woodland. The choice and level (as well as style!) of recreational development is largely a personal matter. Many woodland owners are interested in developing trails, viewing platforms or blinds for wildlife, or special camping sites for family outings. The major timber-related concerns in maintaining or developing the aesthetic and recreational potential of your area will likely involve the

separation of harvesting noise and visibility from recreation trails or sites, and the protection of watersheds and soils. In addition to the private recreation values that you may enhance, small-scale woodland operations often have the potential for community recreation development. Forestry awareness, education and

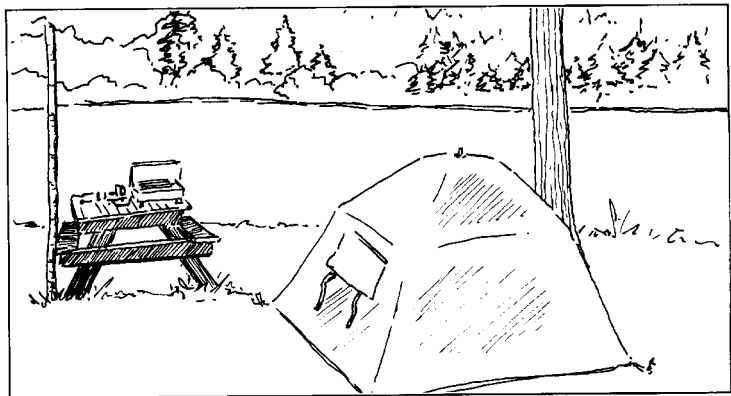

demonstration are opportunities that some woodland operators are beginning to explore with youth groups (such as Junior Forest Wardens) and others in their communities. Local recreation organizations can be a good source of information to woodland operators interested in developing the recreational potential of their woodlands.

The *grazing of domestic livestock* is an important forest land use in the interior of the province, and range management is part of the mandate of the Ministry of Forests. Special range land and forest management programs are in effect in a number of regions, supported by the forest industry, government, cattlemen and other forestry and range agencies. Re-seeding of clearcuts is a fairly common practice to provide good quality forage, and fire is used as a management tool to improve forage production in some areas. Selective cutting practices are used to open dense stands for grazing.

Wildlife management is largely a practice of habitat management. It relies on an understanding of the food, water and shelter needs of different wildlife species and the options for manipulation of habitat to provide for these needs. Habitats can be manipulated directly, through practices such as prescribed burning to stimulate production of browse vegetation, or indirectly, through the modification of forest practices, such as selection cutting.

One of the early steps in managing your area for wildlife will be to determine what types of animals and birds might be using the woodland. To help you with this assessment, regional habitat maps for some areas of the province are available from Ministry of Water, Land and Air Protection. Using an ecosystem classification method, the maps indicate the habitat types in different areas, and their potential to support various wildlife and bird species. Consult with the local office of the Ministry of Water, Land and Air Protection to determine what species your woodland might support, and how you might protect and enhance their habitats.

Once you have identified the wildlife potential of your area, you will need to determine what forest management modifications will be necessary in order to accommodate both, wildlife and timber production, on your woodland property. Most of the costs of managing forests for wildlife will be in the form of reduced harvesting, with some direct costs, such as prescribed burning or the seeding of logged areas and roadsides.

As a general rule, timber harvesting benefits wildlife species such as deer, quail and rabbits that browse or seek shelter in low-growing plants, by opening stands to more sunlight and stimulating the growth of shrubs and other understorey species. The following table summarizes some of the positive and negative impacts of forestry practices on wildlife populations.

Positive Impacts

- logging creates early stages of plant succession, favourable to some species
- clearing for roads, etc. creates more forest 'edge effect' that attracts many species of birds and small mammals
- reforestation accelerates production of dense forest cover valuable as shelter
- fire prevention preserves wildlife habitat
- new roads provide access to game

Negative Impacts

- increased edge effect may allow more aggressive species (plant and animal) to penetrate the forest
- logging removes habitat important to some species
- excessive runoff or soil compaction can create barren areas
- new road access and logging activities may disturb breeding ground or increase hunting pressure on wildlife
- rapid reforestation closes out open area species
- fire control may reduce natural creation of game ranges

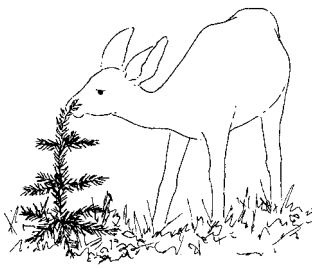

FPC guidebooks and other publications are available on subjects such as road building, streamside protection, watershed sensitivity rating, ground skidding, mule deer habitat and other forest land activities.

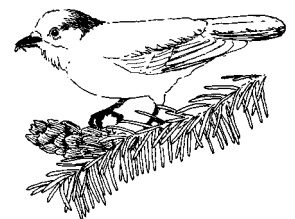

Many of these are referred to and listed as reference material in the appropriate chapters of this book. More general forestry information is available from the Ministry of Forests and the Canadian Forest Service (Pacific Forestry Centre, Victoria), the Small Woodlands Program library and the library of the woodlot association near you.

Safety in the Woodland

Managing a woodland can be an intense and time-consuming activity. It can also be very dangerous. So, the first step in being safe is knowing that you are at risk and what you can do to prevent accidents.

Part of safety is protecting yourself, and making sure that an effective wardrobe of protective gear is readily available. There is no acceptable excuse for not being prepared. Your personal gear is as important as the hardware you use for a job. Shown below are the basic elements of the safe (and long-lived) woodland operator.

The practice of forestry takes place on a large scale- even in ‘small-scale’ operations. It uses powerful equipment and handles large and heavy objects that can easily harm or kill. The active logging phases are the most dangerous activities you will encounter. If you plan to be anywhere near a chainsaw, it is strongly advised that you read the ‘Fallers’ and Buckers’ Handbook’ and ‘Juvenile Spacing Manual’ produced by, and available from the Workers Compensation Board (WCB). Take them with you into the woodland even before you plan to cut. Owning a chainsaw does not make you a safe faller any more than standing in your garage makes you a safe driver! Check out the trees in your stands and look for some of the potential danger situations described. Think out the steps involved in felling specific trees and how you would handle different situations. The time cost is small in terms of the life-saving pointers you may pickup. Be ready to learn—from others with more experience, from special reference materials, and from your own experiences. Know when to ask questions and when to ask for help.

Be aware of WCB regulations and how they apply to you, especially if you are operating a small forestry business. Besides the potential for injury, not being properly prepared can also result in large fines and legal implications.

Equipment is, of course, extremely important. You know the old saying that you can cut yourself just as easily on a dull knife as on a sharp one. Take care of your equipment so that it can take care of your needs, and so that you can depend on it. Learn what maintenance is required, what you can do yourself and what is best left to professionals. *The Chainsaw — Use and Maintenance* provides an excellent overview on everything you should be aware of the care and filing of a chainsaw (see end of chapter for reference).

As important as knowing your equipment and how it works, is knowing your body, its rhythms, its strengths and limitations. Pacing your work is often something that non-professionals need to learn. Listen to your body and work with it. It’s the only one you have and it’s worth taking care of. Operator fatigue is one of the major causes of accidents—work or play. Know when to call it a day.

Included in your toolkit, should be a reference on basic first aid and a first aid kit. At minimum, carry a whistle and a pressure bandage. Don’t work alone. You should know first aid basics, such as how to stop bleeding and treat shock. Take the one-day Occupation First Aid Level One course. It is a small investment of time. Always let someone know where you are going and when you expect to return and leave a note in your vehicle if your plans change.

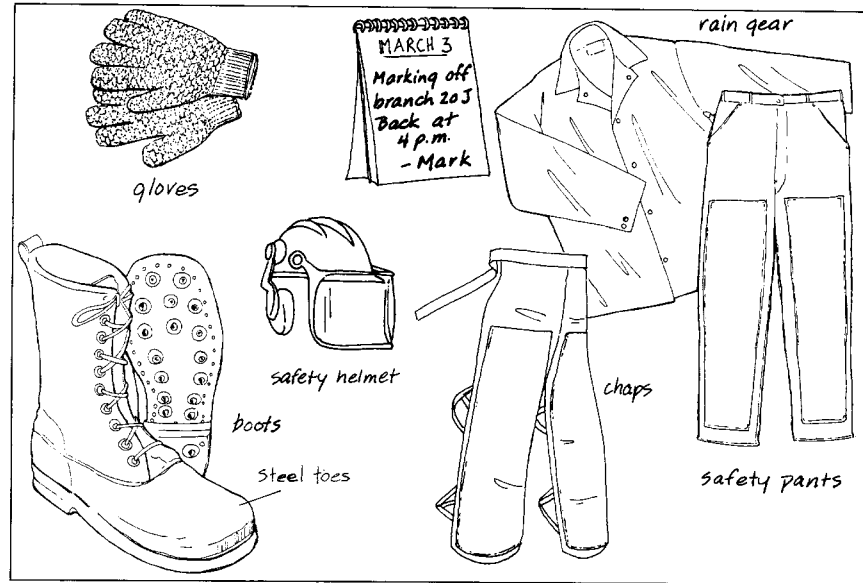

Safety is, in large part, a state of mind. Your attitude and actions are of prime importance. Be alert. Be prepared.

Be careful...and stick around for the second crop.

Recommended References

Small Woodlands Program of BC

A comprehensive 'Small Woodlands Library' is available on the web [www.swp.bc.ca]

Canadian Forest Service

Pacific Forestry Centre

506 West Burnside Road

Victoria, BC, V8Z 1M5, tel.: 250-363-0600, fax: 250-363-0775

[www.pfc.cfs.nrcan.gc.ca]

Publications on many forestry-related topics are available on request from the on-line bookstore at [<http://bookstore.cfs.nrcan.gc.ca>]

Ministry of Forests

Brochures and Publications, FPC Guidebooks, Production Resources, 4th Floor –

722 Johnson Street, PO Box 9523, Stn. Prov. Gov., Victoria BC V8W 9C2,

[www.for.gov.bc.ca/hfd/pubs/Index.htm]

R.N. Green, et al., 1987. *An Ecological Approach to Organizing Forests For Woodlot Management – Lasqueti Island Pilot Study*, Ministry of Forests

Ministry of Water, Land and Air Protection

Wildlife Habitat Handbooks for British Columbia

Workers' Compensation Board,

Safety regulations and education material

Fallers and Buckers Handbook

Juvenile Spacing Manual

P.O. Box 5350, Vancouver, BC, V6B 5L5, tel.: 800-661-2112, fax: 604-276-3247,

[www.worksafebc.com]

Crown Publication Inc.

Federal and Provincial Legislations,

521 Fort Street, Victoria, B.C. V8W 1E7, tel.:250-386-4636 fax: 250-386-0221,

[www.crownpub.bc.ca], on-line legislation research tool [www.qplegaleze.ca]

Queen's Printer

Federal and Provincial Legislation

tel.: 250-356-5850

[www.qp.gov.bc.ca]

The National Board of Forestry, Sweden, 1979. *The Chainsaw – Use and Maintenance.*

Available from the New Brunswick Department of Natural Resources (many chainsaw companies also distribute booklets with their saws)

Hosie, R.C., 1969. *Native Trees of Canada*

Baughman, M. et al., 1993. *Woodland Stewardship.* University of Minnesota, Forestry Extension Service

Fazio, J., 1985. *The Woodland Steward.* Woodland Press, Moscow, Idaho

Farriar, J.L., 1995. *Trees of Canada.* Fitzhenry and Whiteside. Markham, Ont.

Walker, L., 1988. *Farming the New Forest.* Miller Freeman Publications

Hammond, H., 1991. *Seeing the Forest Among the Trees.* Polestar Press, Vancouver, BC

Kimmings, J., 1987. *Forest Ecology.* MacMillan Publishing, NYC, NY

Pritchett, W., 1979. *Properties and Management of Forest Soil.* John Wiley and Sons Publishing

- Beattie, M. et al.**, 1983. *Working with your Woodland: A Landowners Guide*. University Press of New England
- Shirley, H. and P. Graves**, 1967. *Forest Ownership for Pleasure and Profit*. Syracuse University Press
- Klinka, K.**, 1989. *Indicator Plants of Coastal BC*, UBC Press
- Pojar, J. and A. MacKinnon**, 1994. *Plants of Coastal BC*. Lone Pine Publishing, Vancouver, BC
- BC Ministry of Forests**, 1991. *Ecosystems of BC*. Special Report Series #6
- Wiskel, B.**, 1995. *Woodlot Management*. Lone Pine Publishing, Vancouver, BC
- Logan, R.**, *A Handbook of Forest Stewardship for 21st Century Workers*. Montana State University
- Minckler, L.S.**, 1975. *Woodland Ecology. Environmental Forestry for the Small Owner*
- Forestry Undergraduate Society, U.B.C.**, 1983. *Forestry Handbook for British Columbia*. Vancouver, BC
- Crown Publications Inc.**, *Outdoor Safety and Survival*. Victoria, BC
- St. John Ambulance**, *Basic First Aid*. Vancouver, BC
- USDA**, Agriculture Handbook #271. *Silvics of Forest Trees of the United States*, Washington, DC



Basic Surveying Skills

Forest Inventory

In this chapter...

Measuring Direction.....	30
Measuring Distance.....	32
Recommended References.....	34
.....	

Measuring Direction

You will need to master some skills in measuring direction and distance in order to carry out an inventory of your woodland, but also to orient yourself and to locate features in your woodland and plan your management activities.

A compass is used to determine the direction traveled and to locate your position or features in your woodland through triangulation. If you have not yet purchased a compass, one with a mirrored lid that covers the compass face is recommended (forestry grade, 2° precision). The hinged lid has a notch at the top that is useful for sighting through when taking a bearing, and the mirror allows you to read the bearing while sighting.

There are three parts to a compass: the magnetic 'floating' needle which is attracted to the magnetic North Pole; the graduated, movable dial with which you read direction; and the base plate with a hinged mirror, which is marked at the top centre (index marker point) to sight targets on your survey line. A hand compass should be held with both hands, and with arms outstretched in front of the body at eye level. This makes leveling easier and sighting more accurate.

Using a Compass

Before you start using the compass, you should check the *declination* setting. This is the difference in degrees (°) longitude between magnetic North and true North. The declination is set by turning the tiny screw on the movable dial of the compass face.

(Your compass should have a tiny screwdriver on the end of a string that is attached to the bearing plate.) As you turn the screw, you change the angle between the orienting arrow and the meridian lines etched on the glass inside the dial. This action 'sets' your compass for the area in which you are working, so that you can use magnetic North as a true North reading.

The declination will vary according to the area of the province you are in. In western Canada the magnetic North is generally East of true North, resulting in your compass arrow pointing to the East side of the North mark on your compass (e.g., 20°E).

Declination values are printed on topographic maps and sometimes on forestry plans. Be sure to check that your compass declination is adjusted for the part of the province where your woodland is located. Also realise that the magnetic pole is constantly on the move, so that there is a shift of the declination over time (years). If you want to be sure you have the right value, get it for your area from the website of the Geological Survey of Canada, National Geomagnetism Program: [www.geolab.nrcan.gc.ca/geomag/e_cgrf.html].

The direction recorded by a compass is read in terms of its position on a 360° circle, called azimuth, (such as 150°) where North is registered at 0° and 360°. The azimuth is read in a clockwise direction starting from North at 0°, and moving through East at 90°, South at 180° and West at 270°, ending back at the zero point (or 360°) of North.

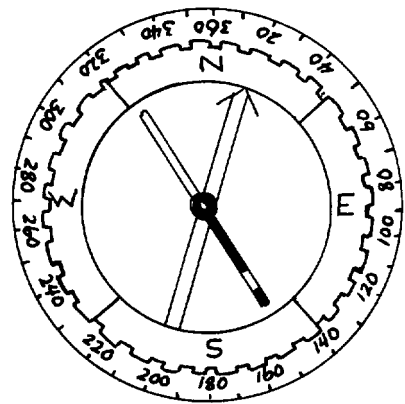

There are two basic ways you will use a compass. One is to take the direction of travel from a map, and is called a map bearing. The other is to take the direction of something in a field in order to locate it on a map; this is called a field bearing.

Following a Map Bearing

1. Read the direction in which you wish to travel from the map (e.g., 30°) by measuring the angle between the direction in which you wish to travel (a line drawn between your starting point and desired end point) and the North line on the map. A transparent protractor ruler works best for this task.
2. Rotate the movable dial on the compass face until this bearing is at the index marker position on the top centre of the bearing plate.
3. Standing at your starting point, move the compass (and yourself - remembering how to hold the compass!) to a position where the etched orienting arrow and the floating needle are aligned.
4. Holding the compass at eye level, with the mirrored lid partly closed so as to reflect the compass dial, move to the position where you can see that the magnetic needle and the etched arrow are lined up. Without moving, look up through the sighting notch on the mirrored lid and identify an object (such as a tree or rock bluff or distant hill) that marks your destination.
5. As you move toward this object, take sightings periodically to check that you are on course (keep the orienting arrow and the floating needle aligned). As you get close to the object (the tree or rock bluff), sight through the compass to another reference point beyond this one, to keep you on track as you travel.

Note: Keep metallic items well away from the compass while doing this!! (e.g., watches, radios, cell phones can significantly influence the compass).

Taking a Field Bearing

1. Hold the compass at eye level, with the mirrored lid partly closed so as to reflect the compass dial. Look up through the sighting notch on the mirrored lid and identify an object (such as a tree or rock or other recognisable feature) that marks your destination.
2. Rotate the movable dial on the compass face until you can see that the magnetic needle and the etched arrow are lined up.
3. Read the bearing at the index marker position on the top centre of the bearing plate.

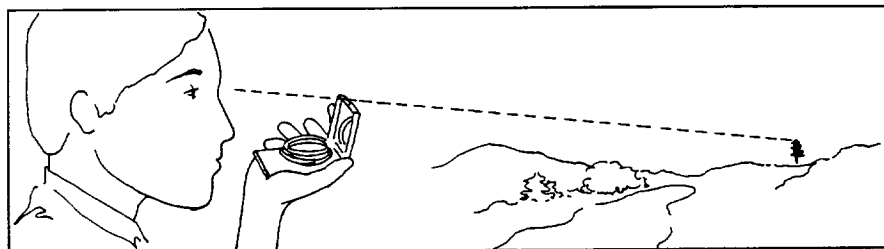

Note: Keep the compass level or the needle might hang up and give an incorrect reading!!

Measuring Distance

Where two people are measuring distance, a 50 metre nylon, pre-stretched line (often called a **chain**) is used. This work can be also completed with one person by using a **hipchain**, which consists of a spool of cotton thread and a metre counter. While you travel with the hipchain through the bush, the biodegradable cotton thread is spooled out and the distance covered recorded.

Using a Chain

In case of a two person crew, the first person (compass person) follows a compass bearing while pulling one end of the chain. At regular intervals the compass person stops, the line is pulled taut and the distance is measured. The compass person marks this point with a stick and flagging tape in the ground. A station number (total horizontal distance) and line number is written on flagging tape at eye level. The second person follows the line to this point, tying more flagging tape to trees and bushes (or other markers) to mark the line of travel, and the process of measuring and recording the distance traveled continues.

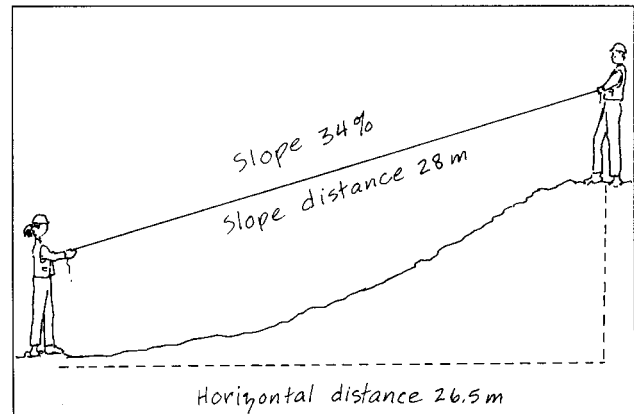

Using a Clinometer

When you are working in sloping terrain, the distance that you travel on the ground must be converted to a horizontal distance to make it possible to record your path on a map.

The most commonly used device for measuring slopes is the clinometer, sometimes called a “Suunto” after a popular brand of clinometer. Inside the clinometer is a wheel which turns freely, except that it is weighted at the bottom to keep it stable no matter whether the device is pointing up or down. On the edge of this wheel is a dial marked in numbered scales, which you can see through a small lens.

As you look through the lens with one eye, keep your other eye open and look past the clinometer's side to the distant object you are sighting on. Your brain mixes these two pictures together. By an optical illusion, you will see the line on the distant object and as you do so you can read the slope % value from the right side of the dial.

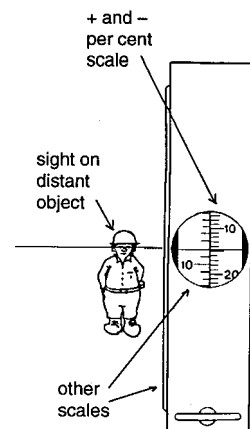

How to Correct Slope Distance

Whenever you need to convert the actual measured *slope distance* (SD) into *horizontal* distance (HD), you can use the following formula:

$$HD = \text{COS} (\text{ARCTAN}[\text{slope \%}] * SD$$

The punch sequence in your calculator is:

1. enter the value of slope % times 0.01 (press =)
2. press INV (2nd F, or SHIFT)
3. press TAN
4. press COS
5. multiply by SD

Example:

You measured a SD = 30.5m, slope % = 15%, what is your HD?

1. $15 * 0.01 = 0.15$
2. *press INV or SHIFT*
3. *press tan = 8.53*
4. *press cos = 0.9889*
5. $*30.5 = 30.16$

Your HD is 30.2m.

It is easier than it appears!!

Slope correction tables are also available that will give you HD for a given slope and measured slope distance.

Recommended References

Small Woodlands Program of BC

A comprehensive 'Small Woodlands Library' is available on the web [www.swp.bc.ca]

Canadian Forest Service

Pacific Forestry Centre
506 West Burnside Road
Victoria, BC, V8Z 1M5, tel.: 250-363-0600, fax: 250-363-0775
[www.pfc.cfs.nrcan.gc.ca]

Publications on many forestry-related topics are available on request from the on-line bookstore at [<http://bookstore.cfs.nrcan.gc.ca>]

Geological Survey of Canada

National Geomagnetism Program
#7 Observatory Crescent
Ottawa, Ontario, K1A 0Y3Canada
tel.: 613-837-4241, fax: 613-824-9803
[www.geolab.nrcan.gc.ca/geomag]

Tahltan Tribal Council, 1992, *Forest Surveying & Mapping*

Equipment Suppliers:

Frederick Goertz Ltd.
314 East 5th Ave.
Vancouver, BC, V5T 1H4
tel.: 604-871-9066, fax: 604-871-9067

Deakin Equipment Ltd.
1361 Powell St.
Vancouver, BC
tel.: 604-253-2683 or 1-800-663-3735, fax: 604-253-4639 or 1-800-634-8388

Canadian Forestry Equipment/ Neville Crosby Industries
445 Terminal Ave.
Vancouver, BC, V6A 2L7
tel.: 604-662-7272 or 877-233-2255, fax: 604-662-8133

Industry Reproduction Ltd.
1 – 610 Richard Rd.
Prince George, BC, V2K 4L3
tel.: 250-562-2185 or 1-800-663-6843, fax: 250-562-2911

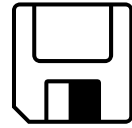

Timber Inventory of Woodlands

Forest Inventory

In this chapter...

Why Do I Need an Inventory?	36
What Is a Forest Inventory?	36
Where to Start?	37
What Kind of Information Do I Need?	39
How Do I Plan My Inventory?	40
Measuring Inventory Plots	43
Compiling Your Timber Inventory	48
Calculating Your Harvest Level	51
Recommended References	54

.....

Why Do I Need an Inventory?

In order to manage a forest it is important to know its character, the forest cover, the plants and animals it supports, their age, location, and condition, and the form and capability of the land itself. The purpose of an inventory is to acquaint you with the character of your woodland and help you to plan how best to protect, manage and use it. An inventory of your woodland is fundamental to determine a sustainable harvest of your forest products. Without it you will be not able to do sustainable forest management.

An inventory must be seen as a long-term investment; it can be considered valid for up to 20 years provided it is updated regularly to account for growth, harvesting and other management activities. It also acts as an important record of the state of your woodland and a basis for measuring and monitoring changes over time. With more sophisticated yield calculation programs becoming available, it is possible to determine the long-term impacts of various management regimes such as enhanced silviculture, forest health management and commercial thinning.

What Is a Forest Inventory?

An inventory is a list of items that exist on your property. A forest inventory collects information on the land characteristics, forest cover, plants, animals, trees and other resource values (water, scenic, range) in a forest area. It will help you to determine what is physically possible and financially realistic in managing your woodland property. You will use the forest inventory to set your management goals, develop your Forest Management Plan, and schedule your on-the-ground forestry operations.

Normally, you would start with a timber inventory and eventually combine it with a vegetation/ecosite classification and stream/lake/wetland inventory.

An inventory of other non-timber resources can also be helpful, since the knowledge of this information will influence your management plan, what areas you want to protect (i.e., riparian zones, archaeological sites, eagle nests) or what kind of management you will apply (i.e., thinning along a recreation trail, avoiding road construction over a limestone cave). You might be interested in discovering options for personal pleasure, such as camping, hiking, fishing and hunting as well as business opportunities such as trapping, cone collection, or the production of salal, ferns or holly for local florists.

Much initial information on non-timber resources such as fisheries, wildlife or recreation can be obtained from resource agencies or stakeholder groups. For instance, provincial agencies as well as the Federal Department of Fisheries and Oceans can provide you with fisheries maps and local information. Contact your local naturalist society and stream enhancement organization to learn more about the area.

Though the same type of information is needed for each of these purposes, the level of detail and precision of the information required is quite different. For example, to define your personal goals for the woodland, you just need a 'sense' of what's out there, while to develop a Forest Management Plan you need to know such things as: when the different stands will be ready for cutting, what stand tending operations will be necessary in the meantime, which stands are infected with insects or diseases, and where water is available in case of fire. To schedule the forestry operations for specific management

areas on the woodland, you need even more detailed and precise information.

The following information in this chapter shows you how to do your *timber inventory*.

Where to Start?

You need a map from your woodland. At the most basic level a simple sketch map of your property will suffice to get you started by showing the general layout and where the various features of your land and forest are located. However, getting hold of a proper map at an appropriate scale will provide you with more accurate and more comprehensive information about your land. In British Columbia maps are available for most of the province and can be obtained from various sources, including municipal or regional offices and government resource management agencies (e.g., agriculture, forestry, environment). In addition, useful websites and a private map distributor are listed in *Recommended References* at the end of the chapter.

Map (and air photo) scales appear in the form of a ratio. This ratio tells you how distances on the map relate to distances on the ground. A map scale ratio of 1:5000 indicates that one unit on the map equals 5000 of the same units on the ground (e.g., 1 cm on the map equals 5000 cm, or 50 m on the ground). The smaller the second number, the larger the map scale. Try to get a map with a fairly large scale (1:5000 is suggested). Obtain the most recent versions possible.

Forest Cover Maps

In BC, most land (both private and Crown) has already been stratified and mapped according to forest ‘types’ or groupings of stands that are similar in species, heights and stocking. These maps are called forest cover maps, and can be viewed and/or obtained at BC Ministry of Forests offices. A lot of information is coded into a forest cover map and it can look quite intimidating to the inexperienced eye. However, each map comes with an extensive legend to help interpret the symbols. Although these maps are not detailed enough to provide all the information required for your management planning (their scale is 1:20 000), they provide a good starting point in getting to know your forested land.

Each polygon (area of similar vegetation characteristics) on the map shows a ‘polygon number’ and forest cover codes. The following figure shows the various codes that are used on forest cover maps.

Your local forest district office maintains a database (FIP file) with quite detailed information for each polygon. It could be possible that you can get a print out of those polygons covering your woodland.

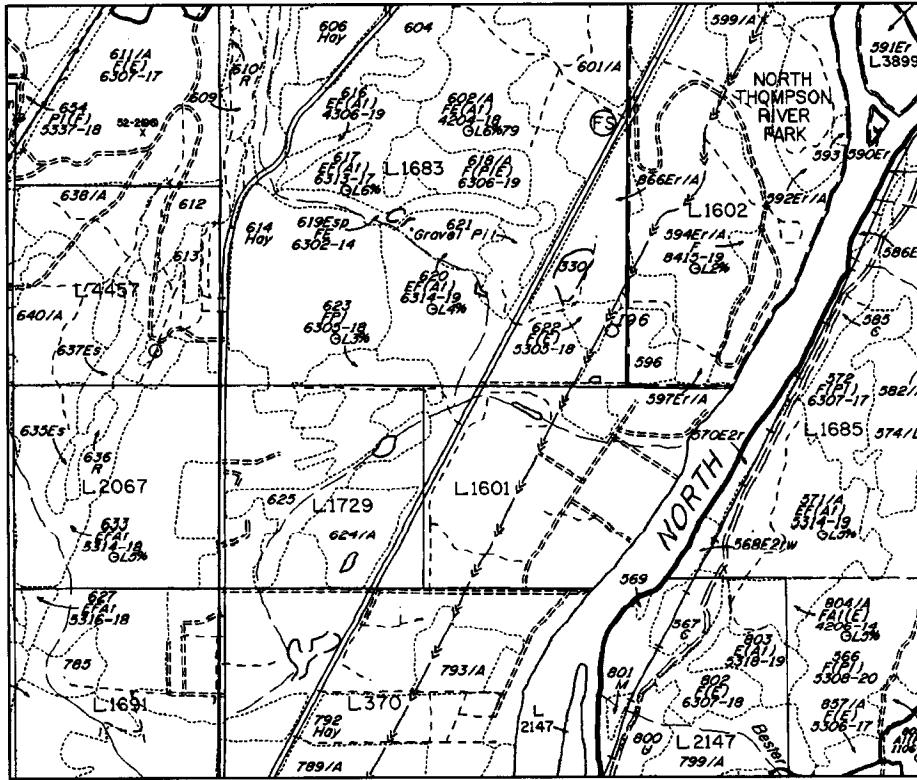

Sample forest cover map

AGE CLASS		HEIGHT CLASS		CROWN CLOSURE CLASS	
CODE	LIMITS (years)	CODE	LIMITS (m)	CODE	LIMITS (%)
1	1 - 20	1	0.1 - 10.4	0	0 - 5
2	21 - 40	2	10.5 -	1	6-15
3	41 - 60	3	19.5 -	2	16-25
4	61 - 80	4	28.5 -	3	26-35
5	81 - 100	5	37.5 -	4	36-45
6	101 - 120	6	46.5 -	5	46-55
7	121 - 140	7	55.5 -	6	56-65
8	141 - 250	8	64.5 +	7	66-75
9	250 +			8	76-85
				9	86-95
				10	96-100

STOCKING CLASS		SITE INDEX	
CODE	APPLIES to	All SI are shown to the nearest meter, referenced at 50 years Breast Height Age	
0	all immature		
1-4	all mature		

FOREST COVER LABEL EXAMPLE:

21 Polygon No.
H(CF) Species
Composition
4209-11 4 Age Class
2 Height Class
0 Stocking Class

Air Photos

The next information source you need are airphotos. Most areas of the province have been covered by flight lines and have been photographed. It is very likely that your land base has been included and that recent photographs are available. You'll receive them on photographic paper, just like a regular photograph (only larger).



Note: Although most of the province has been covered, some areas may not be available.

You will need the largest scale possible to provide you with the most detailed representation of your land. Air photos are normally at 1:15 000 but can be blown up (i.e., to 1:10 000). When you order (ask your local Government Agent), request the largest size available. Also, make sure you order a stereoscopic pair of air photos (two overlapping photos in sequence on the same flight line), showing your woodland in the overlapping area.

What Kind of Information Do I Need?

Depending on the type of inventory, your interest and your objectives for the management of the woodland you want to design your inventory survey to collect just the information you need. If you sample very few areas with lots of data you might end up with very unreliable information, because you did not cover the woodland and you missed the variation in the forest. It is, therefore, better to keep the required plot data brief and have sufficient sample areas (inventory plots).

For the inventory of the timber there are a minimum data requirements in order to be able to calculate a sustainable harvest rate or annual allowable cut (AAC). Additionally, you can add your own checklist of desired data. In any case, once you started, you should stick to the format for the entire inventory survey.

The following description of the timber inventory procedure in this guide is very basic and will be sufficient for small, uniform woodlands. A description of how to deal with a variety of situations is laid out in the Ministry of Forests publication *Woodlot Licence Inventory Manual* or even more in depth in the publication of the Resources Inventory Committee *Ground Sampling Procedures*.

The inventory survey will lead you on a pre-determined course through your woodland with stops in intervals. Those stops are called sample plots and you will measure trees and record other information. The data from those plots will later be extrapolated to represent the forest polygon they landed in.

Besides measuring trees you should record the following information for each forest polygon to the best of your ability:

- species composition, to nearest 5 percent
- average stand height in metres, to nearest 0.1 metre
- crown closure in percent
- slope in percent, most severe slope to a point 15 metre from the plot centre
- dispersed NP (non-productive area) in percent for the entire polygon
- stand structure:
 - a) one, two, or multi-layered (> 10 metre height and > 40 years age difference)
 - b) even or uneven aged
- terrain (even, rolling gullied, broken)
- slope range in percent for polygon or area around plot
- aspect in degree
- soil depth in cm and coarse fragments in percent
- soil texture and humus form
- brush severity
- forest health
- lakes, streams and wetlands
- other resource values
- limitations to management
- suitable harvesting methods
- suitable silviculture systems
- recommended treatments.

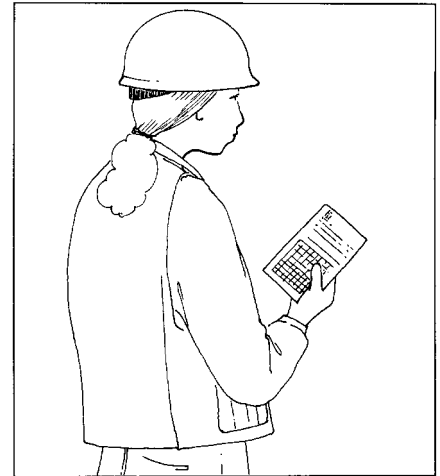

How Do I Plan My Inventory?

Start with your maps and airphotos. On sheets of overhead transparency you can trace out areas of different forest cover, water or rock out crops, fields, building and range land. You'll notice that it's not easy to pick out the different forest polygons on an air photo. Using a pocket stereoscope you can get a 3D perspective, which makes the task somewhat easier.

The biggest challenge is to transfer your polygon sketch from your photo onto your woodland map. This can be difficult because 1) the air photos have a different scale than the map that you are using and 2) air photos are distorted through the variation of the ground elevation and the nature of the photographic lens. You can try to experiment with the enlargement and reduction feature of a copy machine until your sketch on the transparency over-lays approximately the map (use roads and streams for alignment).

If you are not satisfied with the results, or you if you want to start with a proper 1:5000 woodland map, you should have a forest mapping company prepare a map for you. In any

case you should end up with a map of your woodland, showing forest cover polygons, that are numbered in sequence. You also need to know the area in hectares of each polygon. A dot grid, that you can get from a forestry supply store will help to measure (or count) the area of each polygon. Make sure the total area of all polygons equals the area of your woodland.

Where Should I Put The Inventory Plots?

The next step is to determine how many sample plots you need and where they should be located. For determining plot locations, a plot grid can be used that is designed so that each grid line is 100 meters apart on a 1:5000 scale. The intersection of two lines will represent a plot location.

Overlay the field map with the clear plot grid and line it up with the cardinal compass directions (i.e., North, South, East and West). Transfer the plot locations with a 1 plot/ha density onto the map with a lead pencil first. Check to see that every polygon has the appropriate number of plots for its polygon size (see table below) and remove surplus plots in a systematic manner (every second, every third plot, etc.). If plots fall onto polygon boundaries they can be moved in cardinal directions in increments of 50 metres. A buffer of at least 30 metres from the edge of the polygon boundary must be maintained to prevent sampling transition zones. Avoid clumping plots; the idea is to have good coverage over the polygon.

Complete the field map by drafting the base line if required, and connecting the plots with traverse lines. Mark your tie points and tie lines, including the point of commencement (P.O.C.) and the plot numbers. Points of commencement are locations that can be identified on the map and in the field; they are generally the start of your traverse and will help you and other people to follow your lines.

In small areas, generally there will be enough features (e.g., road junctions, creek junctions, bridges) where you can tie your traverse line to. These features are called tie points. Tie points are locations that are identifiable on the map as well as in the field and which are used to locate your traverse lines and plots. In these small areas, your traverse line can zigzag and every second line should be tied into one of these tie points.

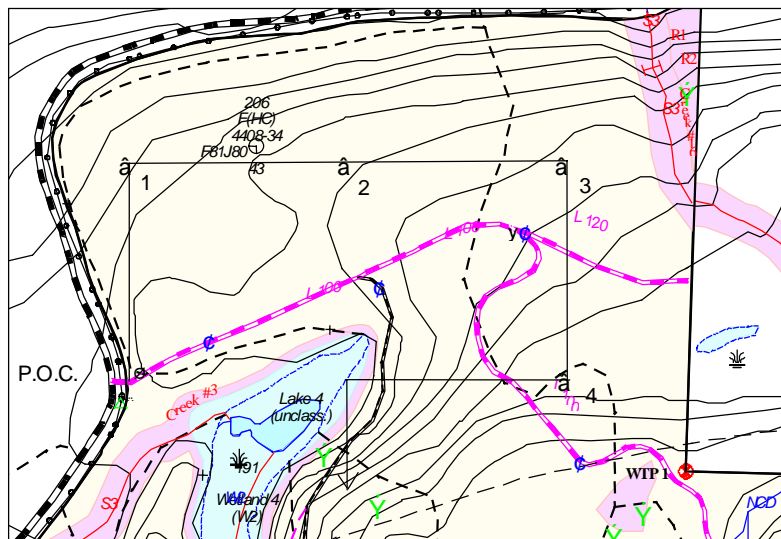

The example above shows a layout of traverse lines and plots on a woodland map. Please note that plot No. 4 falls onto a polygon boundary and needs to be moved along the traverse line to be within a polygon. This correction should be completed before going into the field.

How Many Inventory Plots Are Needed?

All polygons need to be visited on a traverse line to record estimated stand data, but not all polygons need to have plots established. The effect of small polygons on the harvest level is comparably small, so that the systematic sampling requirement will be waived for polygons smaller than 1 hectare. Although polygon delineation of the woodlot map is generally very detailed, it is expected that there will only be a few small polygons.

Polygon Area	Plots per hectare	Procedure
smaller than 1 ha	Walk-through	Traverse through polygon and record stand and site data. Measure age and height from 2 representative top height trees
from 1 ha to 4 ha	1 plot per ha	Traverse through polygon and record stand and site data. Measure age and height from 1 top height tree per plot with a minimum of 2 top height trees per polygon
more than 4 ha	4 plots for the first 4 ha and 1 plot per 4 ha thereafter	Traverse through polygon and record stand and site data. Measure age and height from 1 top height tree per plot

While traversing the polygon, you should observe the stand characteristics and try to estimate attributes such as crown closure and average stand height as an average for the polygon. Even if you do not have to complete an inventory plot (polygon <1 ha), there are mandatory records of data that need to be completed before leaving the polygon. These estimates also have to be completed if you establish a number of plots in a polygon, since this information will not be collected with the tree measurements in the plot.

What Equipment is Required

The timber inventory can be conducted with one or two persons. The following equipment list is sufficient for a one person inventory. For orientation and measuring traverse distances you need a forestry grade *compass* (accurate to 2 degrees and with adjustable declination) and a *hipchain* (meter box with spool of cotton thread) or nylon chain (50 or 100 m measuring chain).

A *clinometer* allows you to measure slope percent, which is also needed to convert slope distances to horizontal distance (as per map) and to measure tree heights. With an 16 inch *increment borer* you will be able to drill and measure the ages of most of the second growth trees. A diameter tape enables you to accurately determine the diameter of trees at breast height. A *tape measure* (50 m) or long logger's tape will help to determine accurate distances for the tree height measurements.

To determine the plot radius you need a *plot cord*, 5.64 m long (100 m² plot). Finally, you will need a *field book*, a *calculator* with sine functions, a small ruler, some water

proof notepaper, field cards, and lead pencils to record the data. If you use a surveyor's vest you can carry all equipment within reach and work comfortably.

Measuring Inventory Plots

From the field map and air photos, find the tie point on the ground and mark it with flagging tape. The traverse line should be marked with flagging tape (i.e., blue) at intervals of about 15 m or less if necessary (so you or someone else can find his way to the plot later). Mark the plot center with a plot center stake, and flagging tape (i.e., orange and blue). Make sure to mark the plot number, polygon number, and the date on the flagging, or if you want it to be more permanent, on a metal tag. Proceed with the plot measurement of the tree data.

The sampling procedure of the inventory plot uses either variable-radius plots (with prism) or fixed radius plots (with plot cord). Once selected, the plot type and size will be maintained throughout the polygon. Individuals using variable radius plots have to be familiar with the use of prisms or the use of a relascope. For a detailed description of the sampling procedures of variable radius plots, please refer to the *Provincial Cruising Manual*.

There is only one size of fixed radius plots to be used (5.64 m radius, 100 m²). The fixed radius plots are easier to implement in the field, especially for individuals, not familiar with operational cruising procedures. The variable radius plots are probably somewhat faster and yield instant stand information. In any case, the required inventory data obtained will be similar.

In circular, fixed area plots, the plot boundary is defined by making a 'radial sweep' with the plot cord, as shown on the diagram. Slope corrections must be made for ground in excess of 10%. A tree is counted 'in' the plot if more than half of its diameter (DBH) is within the plot radius.

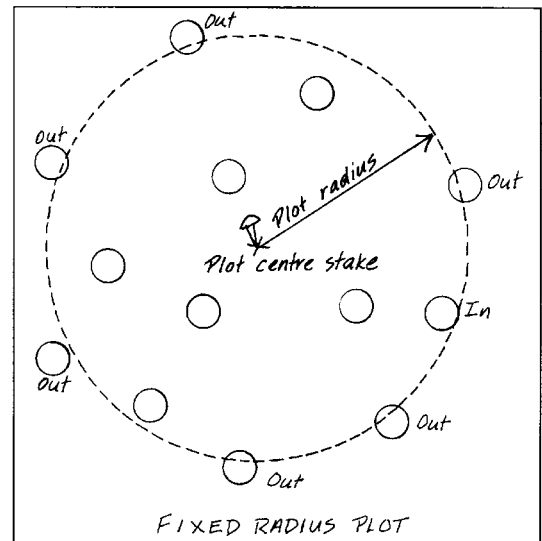

How to Correct Slope Distance

Whenever you need to convert the actual measured slope distance (SD) into horizontal distance (HD), you can use the following formula:

$$HD = \text{COS} (\text{ARCTAN}[\text{slope \%}] * SD$$

The punch sequence in your calculator is:

1. enter the value of slope % times 0.01
2. press INV (2nd F, or SHIFT)
3. press TAN
4. press COS
5. multiply by SD

Example:

You measured a SD = 30.5m, slope % = 15%, what is your HD?

1. $15 * 0.01 = 0.15$
2. *press INV or SHIFT*
3. *press tan = 8.53*
4. *press cos = 0.9889*
5. $*30.5 = 30.16$

Your HD is 30.2m.

It is easier than it appears!!

Slope correction tables are also available that will give you HD for a given slope and measured slope distance.

Measuring Tree Diameter

The most accurate way to measure tree diameter is to use a diameter tape. This is a metal tape similar to a carpenter's tape with a hook on the end that can be fixed in the tree bark.

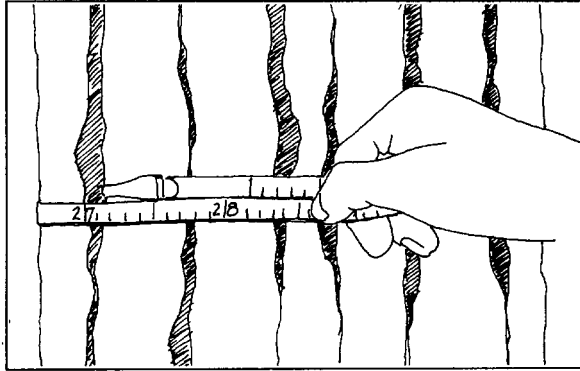

The tape is wrapped around the circumference of the tree at breast height (1.3 m high side of the slope) and the tree diameter (DBH) is read directly off the scale to the nearest tenth of a centimetre. If you develop an eye for estimating the DBH, you can try to speed up your routine, but keep testing yourself occasionally.

Record the diameter class of all merchantable live/dead, standing/fallen trees equal to or greater

than 12.5 cm DBH. A tree with rot has to be more than 50 % solid in order to be merchantable. The diameter classes are in 5 cm intervals, beginning with 12.5 cm.

Measuring Tree Age

The age of a top height tree is usually determined by boring with an increment borer, a type of auger. When bored into the centre of a tree, it takes a small core sample of the tree's growth rings that can be removed with an extractor and counted. It is important to bore across all the annual growth rings and reach the centre of the tree in order to correctly establish the tree's age at breast height. The very centre, or pith of the tree is usually a darker colour and different texture than the rest of the wood, so you can tell whether or not it has been reached.

Increment cores are usually bored at breast height (DBH) on the tree, which means that you must add to the number of rings counted in the core sample, the number of years it took the tree to grow to the height at which the sample was bored. This correction will vary by tree species and site class. Site index tables or computer programs let you calculate the total age and site index, based on your measured values: breast height age and height.

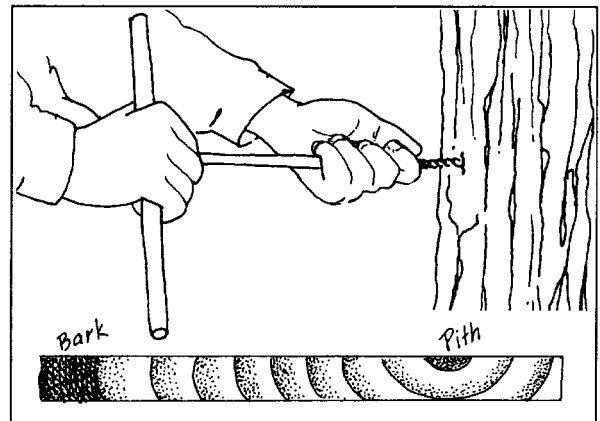

What is a Top Height Tree?

The official definition of top height is “the average height of the 100 largest-diameter trees per hectare.” For purposes of your timber inventory, the top height tree is defined as the largest diameter “suitable” tree in a 100 m² (5.64 m radius) plot.

The main purpose of top height tree samples is to determine the site index and the age of a stand. The number of top height trees to be sampled in a polygon is specified in the previous table. You need to sample at least two trees for height and age per polygon as top height trees.

If a “suitable” tree does not exist in the plot, then the nearest suitable tree to the plot center will be selected.

Suitable trees are:

- of the leading tree species
- dominant or codominant tree (see definition in Glossary)
- standing and live
- without damage that significantly affects height growth
- not suppressed
- not a veteran tree.

Free of major forks or crooks; dead tops are acceptable only in exceptional circumstances (e.g., all trees in a mature cedar stand have dead tops).

If the leading species cannot be accurately assessed, it may be necessary to collect top height data on several species in order to ensure that at the end of the inventory survey the correct species was selected for top height measurement.

Measuring Tree Height

Top height tree measurements are done with the clinometer, which allows you to measure the slope percent to the top and bottom (at breast height) of the tree. When those two measurements are combined with the distance to the tree, you can work out its height. To use the clinometer:

- locate a spot (preferably uphill) from which you can see both the top and bottom of the tree
- hold the clinometer to your right eye to read the values from the internal scale
- look at the target tree with your left eye
- tilt the clinometer so you can see the top of the tree and read the right side of the scale (in %); record the reading on your plot card under ‘top height tree details’
- tilt the instrument to the base of the tree (at breast height), and record the reading
- measure the horizontal distance to the base of the tree and record the measurement on your plot card
- plug the values into the formula (see table below) to determine tree height.

Although you don’t need to do the math out in the field, you should record your best estimate of average stand height at each plot. If there is a wide variety of tree sizes, record the range of sizes and plot the information showing the percentage in each size.

Formula for Tree Height Calculation

$$\text{Tree height} = (TT + TBH) \times HD \times .01 + 1.3 \text{ m}^*$$

Where: TT = Tree top reading (%)

TBH = Tree reading at breast height (%)**

HD = Horizontal distance from tree (slope corrected)

* 1.3 m is the height at DBH where you took your 'bottom shot.'

** Bottom readings are usually a negative number expressed as a percent; ignore the negative sign and just add the bottom percent to the top percent. Where you're looking uphill for your shots and both percent readings are positive, SUBTRACT the tree bottom percent reading from the tree top percent reading.

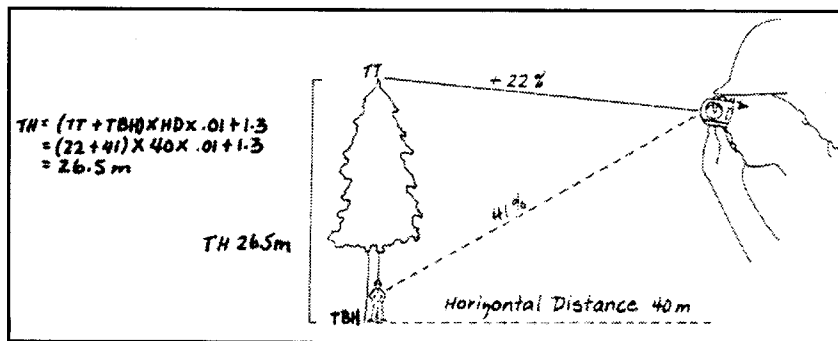

Field Cards

The plot information can be recorded on timber inventory plot cards, which you can copy from the plot card templates at the end of this chapter. Here is an example of completed plot card.

LICENCE NO.	LICENSEE	LOCATION	LINE No.	PLOT No.	POLYGON	SURVEYOR	DATE
W 2000	B. FAST	UNIT 2	1	4	205	B. FAST	99/03/15

PLOT TALLY													
PLOT RADIUS		PLOT SIZE		PLOT FACTOR		BAF		DBH Limit		LAYER			
5.64 m		100 m ²		100				12.5 cm		<input checked="" type="checkbox"/> TOP		<input type="checkbox"/> BOTTOM	<input type="checkbox"/> REGEN
TREE SPECIES	15	20	25	30	35	40	45	50	55	60	BA m ² /ha	AVER. HEIGHT	VOL. (m ³ /ha)
DBH CLASS													
Fd					*	**							
Hw					*								
CW	*		*										
D+				*									
TOTAL	1		1	1	2	2					7	700/ha	

TOP HEIGHT TREE DETAILS										Height Calculation					
TREE No.	HEIGHT (total)	SPECIES CODE	DBH	CROWN CLASS	TOTAL AGE	SI 50	BH AGE	YEARS to BH	TOP SHOT	BOT. SHOT	TOTAL	SLOPE DIST.	SLOPE %	HORIZ. DIST.	HEIGHT (BH)
2	42.6	Fd	39.8	D	67	38	60	7	95	-10	105	39.5	-10	39.3	41.3
4	43.2	Fd	42.1	D	72	37	65	7	93	-5	98	42.8	-5	42.7	41.9

WOODLOT INVENTORY PLOT CARD 3/99

Compiling Your Timber Inventory

After completing the field sampling for the timber inventory, it is necessary to organize the information and to compile the data. The following steps have to be completed in this order:

- update your maps with field information
- determine which plot belongs to which polygon
- determine species composition in each polygon
- get site index for top height trees
- average the age and site index
- average the crown closure, dispersed non-productive area, etc.
- create stand attribute table for all polygons.

Updating the Maps

The first step after completing the field work is to update your maps from the field notes in order to record changes of plot or survey line locations and any polygon boundary corrections. All additional information such as new streams, swamps, steep or unstable terrain, unique features should be entered soon after returning from the field since many details will be fresh in your memory. Even if the maps will be updated electronically, it is good to summarize all new information first on a single paper copy. During the compilation process, you can then refer to this base map and confirm plot locations, timber types and terrain data, for example.

Organizing the Plot Cards

The next step will be to group the field cards according to polygons and to establish a reference list that shows which plots are in which polygons. The order of the polygon numbers should be ascending; this will be maintained throughout the entire compilation.

Check if the plot density requirement is achieved and the information on the field cards is complete. The height measurements should be computed for total tree ages if this has not already been done in the field.

Compiling the Data

The compilation will be completed for each polygon separately. The first step is to determine the species composition by basal area.

Species Composition

If *variable radius plots* were recorded (prism or relascope), the calculation is quite simple. For each tree recorded on the card, take the particular basal area factor (BAF) and add all BAFs of the same species of all plots in one polygon. Divide the sum by the number of plots sampled in this polygon or layer to derive at the basal area (BA in m²/ha) of a particular species in this polygon. Divide the BA of a particular species by the total BA of all species of all plots in a polygon and multiply with 100 to derive at the percentage of a particular species. Repeat this step for each species.

If *fixed radius plots* were used, the basal area of each counted tree has to be calculated with the following formula:

$$BA(\text{tree}) = \pi * (\text{DBH}/2 * 0.01)^2 \text{ units are m}^2/\text{ha}$$

The following table shows the relationship between the diameter and the basal area of a tree at diameter class mid point. For simplicity, every tree counted in a particular diameter class will be calculated with the diameter at class mid point.

DBH	Area (m ²)	DBH	Area (m ²)	DBH	Area (m ²)
15	0.018	45	0.159	75	0.442
20	0.031	50	0.196	80	0.503
25	0.049	55	0.238	85	0.567
30	0.071	60	0.283	90	0.636
35	0.096	65	0.332	95	0.709
40	0.126	70	0.385	100	0.785

The BA(tree) of all trees of the same species from all plots of the same polygon are to be added together and divided by the total BA(tree) of all trees of all plots. Multiply by 100 in order to derive at the percentage of a particular tree species. If this is completed for all counted tree species in a polygon, the species composition has to add up to 100%.

Following is an example of a species composition and forest cover label:

Fd65 Hw20 Cw12 Dr3 FH(C)

Top Height (Site Index) Tree

The site index will be determined from the dominant and codominant top height trees of the leading species in a polygon. For each relevant top height tree, look up the site index in the corresponding site index table (*Site Index Curves and Tables*, 1991, MoF).

The breast height age helped to determine the site index value. To get the total age of a top height tree, the years to breast height have to be added to the sampled breast height age. The site index tables also show the years to breast height for the various species and site indices.

Build the average of the age and site index values of the relevant top height trees in a polygon to derive at the age and site index for this polygon. If the leading species of a stand is different from those provided in the site index tables, it is possible to substitute some species using the following list:

- Yc with Cw
- Hm with Hw
- Bg with Ba
- Mb with Act

Crown Closure and Dispersed Non-Productive Area

The crown closure and dispersed non-productive area (NP) estimates are to be averaged for each polygon. Crown closure and dispersed NP are important values that affect the calculated growth and yield of each polygon. The crown closure percent is the amount of sky, that is obscured by tree cover, if you are within the forest looking up. Dispersed NP

are those swamps, rock out crops and other spots that are not suitable for growing trees within a polygon. If an NP area shows up on the map and can be netted out by measuring the size, it will not be counted as dispersed NP.

Completing the Stand Attribute Table

After compiling all polygon data, the stand attribute table is to be completed for each polygon.

Poly #	Operable AREA (ha)	AGE	HT	SITE INDEX	Spec 1	Spec 1 %	Spec 2	Spec 2 %	Spec 3	Spec 3 %	Spec 4	Spec 4 %	Spec 5	Spec 5 %	CR CLOS	NP %
1	16.44	60	20.8	20.8	Fd	97	Mb	3							5	3
3	1.00	25	9.1	21.9	Fd	90	Cw	5	Hw	5					20	10
4	0.69	51	23.1	25.7	Fd	50	Hw	40	Cw	10					70	5
5	1.21	40	16.5	21.5	Fd	95	Pl	5							90	10
6	2.93	25	8.8	21.1	Fd	90	Cw	10							20	5
7	4.84	59	13.3	13.6	Fd	95	Cw	5							40	5
8	5.30	36	14.0	21.5	Fd	95	Pl	5							90	10
9	5.42	57	22.1	22.8	Fd	100									68	10
10	2.44	60	18.2	18.5	Fd	95	Pl	5							70	10
12	1.29	59	29.7	29.4	Fd	95	Cw	3	Hw	2					60	3
13	2.48	63	21.3	20.6	Fd	98	Cw	2							80	0
14	0.81	25	8.8	18.0	Hw	70	Cw	20	Fd	10					50	5
16	18.79	63	21.3	20.6	Fd	98	Cw	2							75	5
17	5.14	47	15.6	18.6	Hw	50	Cw	25	Fd	25					60	10
Total	68.78															

Completing the Stand Data Table

If optional data were collected during the inventory sampling, one table for each polygon can be prepared. This way a reference record exists which will help in future planning and presentation. The inventory data can be projected every five years to reflect the stand growth and development.

ID		STAND DESCRIPTION													Record	2
Stand	Area	Tree Species Composition		Age	Height	dbh	Crown Closure	Site Index (ht @ 50 years)	Basal Area	# of stems/ha	Volume	Operab. Area	Total Merch. Volume	MAI	Rotation Age	
No.	ha	Spec.	%	yrs	m	cm	%	m	m ² /ha	Total	m ³ /ha	ha	m ³	m ³ /ha/yr	yrs	
2	2.17	Fd	45	74	32.0	35.1	65	30.6	46.9	263	536	2.17	1163	7.7	120	
Forest Parcel		Cw	45	Notes	Light thinning from below, Fd regen present, retain Cw wildlife trees											
W 2000/C		Pw	5													
Working Group		Mb	5													
I																
Year of Survey																
	1998															
Site Type	CWHxm 01	Slope (%)	6	Soil Depth (cm)	100	Brush	M-H									
Elevation (m)	61	Soil Texture	LS	Coarse Frag.(%)	30	Silvi. System	GS									
Aspect (°)	75	Humus Type	Moder	Comp. Hazards	M	Harv. Method	S, GC, H									

* Silviculture Systems: Clearcut (CC), Patch Clearcut (PCC), Shelterwood (SW), Group Selection (GS), Single Tree Selection (STS)

** Harvesting Systems: Highlead (HL), Groundlead (Gc), Skidder, Harvester (S), Horse (H)

Calculating Your Harvest Level

The **operational** area of each polygon has to be calculated for the harvest level calculation in order to include only those areas which are productive and can be realistically managed. This procedure is called net-down and you should try to consider any present and future limitations to your operations.

Common factors that can be measured on a map and netted out per polygon are: riparian reserve zones and other reserves, swamps, lakes, roads and right-of ways, unstable terrain, hydro lines, gravel pits, inaccessible portions of the woodland. If there are areas to be reserved in the future that are can not yet located, it is possible to apply a general net down factor during the harvest level calculation.

Poly #	Total Area (ha)	Operable Area within WLL (ha)	Inoper. Area within WLL (ha)	Lakes & Wetlands (ha)	Riparian Reserves (ha)	Road/ Right of Way (ha)	Comments or Class
12	5.5	5.5	0.0				Fd on poor ridgetop stand
22	7.4	6.1	1.3		1.1	0.2	thriving young Fd stand; fish in wetland
35	4.3	3.8	0.5		0.5		Fd at CT age; little root rot
36	1.3	1.3	0.0				marginal Dr stand, wet
37	7.5	7.2	0.3		0.3		healthy mixed stand, wet
38	31.4	30.3	1.1		1.1		Fd at CT age; heavy root rot
39	6.9	0.0	6.9	6.9			W1 wetland, creeks, elk, deer
40	1.3	0.0	1.3	1.3			W2 Hardhack swamp
41	1.3	0.0	1.3	1.3			W2 Swampy, deep pools
42	2.5	1.3	1.2		1.2		essentially wetland, immature Dr
43	1.8	1.6	0.2		0.2		Fd at CT age; little root rot
44	8.8	8.8	0.0				Fd on poor site, high brush (salal)
	80.0	65.9	14.1	9.5	4.4	0.2	

The completed stand attribute table contains all necessary data needed for the harvest level calculation.

At this point you should seriously consider seeking professional advice to run your harvest level calculation. There are a lot of other variables and woodland characteristics to be considered to create a realistic model of the growth and yield rate of your woodland.

However, since you have come this far you might want to give it a try and do your own *test run*. The best tool currently available to compute a harvest level of a small-scale woodland is the *Woodlot* program. The program is public domain, sponsored by the Ministry of Forests, and can be downloaded from the following website: <http://www.enfor.com/software/woodlot/index.htm>.

There are two ways to enter the data into the *Woodlot* program:

Manually key-in into the data screen or import a table from a spreadsheet. The latter method is time saving, especially if the data is already entered on a spread sheet. On the other hand, the program would not recognize all possible errors, so that locating the error can become a frustrating exercise. For the novice program user, it is recommended that the data entry screen of the *Woodlot* program be used.

Polygon Data - C:\Program Files\Woodlot2\wltest2.lot

File Polygon Yield View

Polygon Data - Common

Mapsheets - Polygon#	Net Area (ha)	Road Net %
9803n4 320	0.9	0.0
9803n4 329		
9803n4 332	Current Age	Regen Delay
9803n4 334	125	[0]
9803n4 335	Utilization (dbh)	F.I.Z.
9803n4 339	17.5	G
9803n4 390	Ownership	
9803n4 398	Crown	
9803n4 421		

Silviculture System

Clearcut
 Partial Cut
 Commercial Thin

Yield Type

Existing Management	Harvest	View Existing
Natural-VDYP	122	View Existing
Future Management	Harvest	View Future
Managed-TIPSY	122	View Future

Natural - VDYP Specific Data

Site Index	SI(tot) Age	SI Height	Cm Close
0.0	125	30.0	70
PSYU	VAF	Stock Class	
112	1.00	0	

Managed - TIPSY Specific Data

Density (S/ha)	SI(bh) Age	OAF1
1600	125	15
<input checked="" type="checkbox"/> Thin (S/ha)	1200	Planted
		OAF2
		5

VDYP Species - 47 loaded

Species	Percent	SI	SI Height
FD Fir-Douglas	80		
L Larch	20		
- None -	0		
- None -	0		
- None -	0		
- None -	0		
- None -	0		

TIPSY Species - 13 loaded

Species	Percent	SI	SI Height
FD Douglas fir	100	19	0
- None -	0		
- None -	0		
- None -	0		
- None -	0		

You must add a Polygon before you can modify or add any data. To add a polygon, press the <+> button in the polygon data window, or use the Polygon Command. Enter new mapsheet and polygon numbers in the pop up window. Use up to 8 characters for mapsheet and 4 characters for the polygon #. The model will

For more background information, consult the manual for the *Woodlot* program, which is also available on the Enfor website.

Recommended References

Small Woodlands Program of BC

A comprehensive 'Small Woodlands Library' is available on the web [www.swp.bc.ca]

Small Woodlands Program of BC, 2000. *Private Woodlands Planner*, software

[www.swp.bc.ca]

Canadian Forest Service

Pacific Forestry Centre

506 West Burnside Road

Victoria, BC, V8Z 1M5, tel.: 250-363-0600, fax: 250-363-0775

[www.pfc.cfs.nrcan.gc.ca]

Publications on many forestry-related topics are available on request from the on-line bookstore at [<http://bookstore.cfs.nrcan.gc.ca>]

Ministry of Energy and Mines

"The Map Place" Geological Survey Branch,

PO Box 9320, Stn Prov Govt,

Victoria, BC, V8W 9N3

tel: 250-952-0386, fax: 250-952-0381

[http://ebony.gov.bc.ca/mapplace/minpot/new_xmap.cfm]

Ministry of Sustainable Resource Development

Base Mapping and Geomatic Services Branch

PO Box 9355 Stn Prov Govt

Victoria, BC, V8W 9M2

tel: 250-387-6316, fax: 250-356-7831

[<http://home.gdbc.gov.bc.ca/>]

Ministry of Sustainable Resource Development

Terrestrial Information Branch

PO Box 9993 Stn Prov Govt, Victoria, BC

Physical Address: 722 Johnson St., Victoria, BC

tel.: 250 387-8891

Vegetation Resources Inventory, 2001. *Ground Sampling Procedures*. Version 4.2.

Prepared by Ministry of Forests Resources Inventory Branch

for the Terrestrial Ecosystems Task Force

Resources Inventory Committee,

[www.for.gov.bc.ca/resinv/veginv/publications.htm]

Woodlot Licence Inventory Guidelines

[www.for.gov.bc.ca/resinv/STANDARD/igwtoc.htm]

Ministry of Forests, Vancouver Forest Region,

Woodlot Licence Inventory Manual, 1999

Ministry of Forests, Victoria,

Provincial Cruising Manual

Site Index Curves and Tables for B.C., 1991

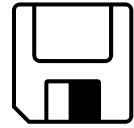

Woodland Management Planning

Management Planning

In this chapter...

Why Is a Management Plan Important?	56
What Is Planning?	57
What Does a Forest Management Plan Look Like?	57
How Do I Develop a Forest Management Plan?	59
Sample Forest Management Plan.	66
Recommended References	69

.....

Why Is a Management Plan Important?

Forest management is a long-term process. Desired forest conditions and outcomes can take many years to develop and you need to plan your actions long before you achieve your objectives. For example;

- thinning and harvesting areas must be selected so that roads can be developed to them
- density management and/or pruning must be done at the right time in order to produce future desired wood quality and value
- reforestation needs must be defined so that seedlings can be grown for planting (1–2 years or more in advance!)
- wildlife habitat conditions (cavity nesting trees, coarse woody debris, understory composition, stand structure) and/or desired forest amenity features (big trees, species mixes, forest gardens, viewsapes) need to be thought out and management interventions planned to achieve the desired conditions in a reasonable time
- timber harvesting, in itself, involves many steps—equipment must be scheduled, contracts arranged and products delivered.

Proper planning helps make these management activities more efficient and helps you to avoid unnecessary costs and delays, as well as unnecessary steps, as you develop your woodland.

A Forest Management Plan is a statement about both the woodland and you, the woodland manager. It describes your woodland or farm property, the resources on it, and the activities you plan to undertake. It will also reflect your own personal interests and expectations, your abilities, your financial objectives, and the goals you wish to achieve. The Forest Management Plan is a blueprint for the long-term and short-term activities needed to achieve your goals.

Developing a Forest Management Plan for your land is fun, interesting, a real learning experience and will create a salable portfolio if ever you want to sell your property. If you are planning to pass the land on to your children, you will have a record of what you have done and why you have done it. There are many advantages to having a plan, not the least of which is the joy of looking back and seeing the tangible results of your efforts.

In some instances a Forest Management Plan can be required on private land if the owner wishes to pursue certain opportunities. A Forest Management Plan is required:

- to qualify for provincial ‘managed forest land’ classification and reduced property taxes
- by the Canadian Customs and Revenue Agency if you intend to pass on your woodland on to your children and qualify your family for intergenerational transfer income tax relief
- if you wish to seek forest certification of your woodland
- if you are seeking financing or assistance for woodland management activities
- if you have a Crown woodlot licence in BC.

In general, a Forest Management Plan is recommended for any woodland property. It is a framework for clear thinking that will help you to organize your resources and your actions to achieve your goals for the property.

This chapter discusses how a Forest Management Plan is developed. It outlines the planning steps you should follow, what you need to consider, what type of information you need to assemble.

What Is Planning?

Planning is the process by which you determine your goals, identify the steps required to achieve them, and measure your achievements. The process of preparing a plan forces you to clarify the benefits or goals you want from your woodland. It helps you to identify the alternative ways these goals might be reached, and to choose the most effective means of achieving them. The Forest Management Plan also acts as a record of the condition of the woodland and a basis for monitoring changes over time.

Planning is a step by step process and includes the following:

1. setting goals
2. identifying alternative means for achieving them and forecasting outcomes
3. selecting the preferred option
4. developing a set of actions (operational plan) to carry out this option
5. monitoring the plan to see if the goals are being achieved.

Although the planning process results in the production of a 'plan' the process of planning does not stop but continues over time. As time passes, conditions change, new information becomes available, adjustments need to be made, and perhaps new ways of dealing with a situation are developed. These are reviewed and incorporated into a plan to keep it up-to-date. Consequently, planning is a cyclical process which is repeated on a periodic basis to keep things up to date and evolving over time.

What Does a Forest Management Plan Look Like?

A Forest Management Plan is a portfolio of information about your woodland coupled with a description of your goals and how you plan to achieve them and monitor your success. It can be as simple and as short as you care to make it or more detailed and comprehensive as dictated by the the complexity of your woodland, your management objectives or external requirements such as certification.

A Forest Management Plan usually encompasses two or three levels of actual planning.

- a long-term plan for 10 to 20 years or more
- a medium-term tactical or 'activity' plan for the next five years
- an annual plan of activities (updated for each year).

While there are various formats used, a basic Forest Management Plan consists of a written section and one or more accompanying maps. The written section usually includes:

- your personal goals for the property
- a general description of the woodland (inventory)

- a statement of your long-term management objectives (e.g., covering 20 years or more)
- a description of the management options and strategy
- a description your short-term area specific activity objectives
- a description and schedule of proposed short-term activities (e.g., over two to five years)
- proposed management standards and guidelines
- a schedule for monitoring key indicators and maintaining records
- references to associated plans, information and records.

The map component of the plan provides the visual presentation of your woodland resources and planned management activities. It lets you see where things are located, how activities relate to each other over time and space, and where there are constraints or potential conflicts. Your maps are also important for doing quick area calculations, distance measurement and initial layout and planning of your management activities.

In cases where management plans are required (e.g., tax assessment, certification) the contents of the plan will normally be specified in general or specific terms (see following boxes for examples). While the specific requirements vary between standards, the principles and basic structure are often very similar and there are usually overlaps in the content requirements. This is important to know because it can help you design your Forest Management Plan to ensure that it meets any requirements that you may wish to subscribe to, and one plan can often be developed that satisfies several requirements at once saving you time and money. Before you embark on developing a Forest Management Plan, consult a forestry professional and make sure you check out any requirements that might apply or that you may wish to conform with.

**BC Assessment Act
Management Plan Requirements for Managed Forest Land Classification**

- a) A map and written description of the land showing: the capability of the soil to grow forest crops; the topography of the land; the means of access to the land and the nature of the trees growing on it.
- b) A statement outlining the objectives of the plan during the first 5 years and for one complete growing cycle.
- c) Undertakings to implement the plan and commitments to:
 - (i) Reforest land to defined standards within 5 years of harvesting.
 - (ii) Reforest any productive land not forested at the time of classification to defined standards within 10 years.
 - (iii) Maintain and harvest the tree crop at the proper time and in accordance with standards.
 - (iv) Tend the land after reforestation in such a manner that tree seedlings will achieve and maintain free growth without inhibition of tree brush or excessive tree competition.
 - (v) Protect the soil and forest from disease, insects, fire and where practicable windthrow, landslides, or rising water.
 - (vi) Monitor regeneration and stocking at regular intervals
 - (vii) Review the plan within five years of starting and at least every five years afterwards
- d) The methods and practices to be used to implement these undertakings and an outline of the location of harvesting and reforestation activities and when they will implemented.

CAN-CSA Z809-96 Requirements for Sustainable Forest Management Plan

An SFM plan must include a long term forecast and be revised at least every 10 years. It must also include:

- a) a summary of the results of activities for the previous planning period
- b) a statement of values, goals, and indicators (*a measurable variable used to report achievement*)
- c) a statement of management strategy
- d) a statement of management objectives for each indicator and schedule for achievement
- e) current quantitative information for each indicator (ie inventory)
- f) a description of the assumptions and analytical methods used for forecasting
- g) a description of the forest management activities to be undertaken
- h) an implementation schedule of sustainable forest management activities
- i) a monitoring procedure
- j) a demonstration of the links between short-term operational plans and the management plan

Forest Stewardship Council Certification Requirements for Forest Management Plans

- a) Management objectives.
- b) Description of the forest resources to be managed, environmental limitations, land use and ownership status, socio-economic conditions, and a profile of adjacent lands.
- c) Description of silvicultural and/or other management system, based on the ecology of the forest in question and information gathered through resource inventories.
- d) Rationale for rate of annual harvest and species selection.
- e) Provisions for monitoring of forest growth and dynamics.
- f) Environmental safeguards based on environmental assessments.
- g) Plans for the identification and protection of rare, threatened and endangered species.
- h) Maps describing the forest resource base including protected areas, planned management activities and land ownership.
- i) Description and justification of harvesting techniques and equipment to be used.

Plan content requirements for new (December 2001) federal intergenerational transfer tax benefits for woodlots had not yet been specified at the time of publication. It is anticipated that these will include an outline and schedule of planned management activities (similar to BC Assessment) that meet the requirements for sustainable forest management as defined in the national context. The plan will be required in order to demonstrate that the woodland is being actively managed prior to the transfer and that it will continue to be actively managed by your children afterwards. For more details please consult the Canadian Customs and Revenue Agency or your accountant.

How Do I Develop a Forest Management Plan?

In a sense, the development of a Forest Management Plan is what this book is all about. The individual chapters provide detailed information on the different phases, activities, and options associated with planning and managing. You can prepare your plan yourself by following the steps outlined below, or you can hire a forestry professional to do it for you.

Whichever route you take, one of the most important first steps you can take is to **learn as much as possible about your land and the management options available**. Keep your mind open about how you wish to manage your woodland until you have learned about the

options and are ready to consider what you can do and what you really want to do.

A second important tip is to **start simple and let the plan develop as you learn** more about your woodland, your goals, and your capacity and ability to manage your woodland. Don't expect to write the perfect plan the first time around. Start by focussing on just a couple of activities and build up from there. It may take you several drafts as you learn about your woodland and you options to end up with what you want. This is a normal part of the planning process.

The third important tip is to **make sure your plan suits you, your goals, management style and your philosophy**. Do it yourself, if possible. The more relevant it is to you the more you will use it and refer to it over time. Though in some cases the formal plan may be prepared by someone other than yourself it is important that it reflects your goals and that you understand how it is prepared, where choices exist and on what basis decisions are made. It has been found in BC and elsewhere that more than half of the management plans prepared by non-landowners are never used by the owners.

The fourth and final tip is to make sure you **write it down**. A documented plan serves as an important record for yourself, your family, third parties who may need to assess what you are doing, and for the future managers of the woodland whether they be your children or a new purchaser.

The following sections present a step by step approach to management planning.

1. Identify Your Personal Goals and Objectives

Your personal **goals and objectives** are about what you want to happen on your land over the long term, what you would like to achieve. Start out by asking yourself: **“why do I own my land?”** This is the best way to focus in on what your **goals** are. Think about your personal and family interests, your financial and estate planning goals, your personal skills and abilities, how much time you have to dedicate to your woodland and whether you intend to do it yourself or use outside help.

While the **goals** represent the vision for the woodland, your **objectives** represent the tactics used to implement that vision. The management goals establish the long-term (i.e., 20–100 years) framework for all your forest management activities. They will be the basis on which more detailed shorter term activity objectives are set out (later in this process) for specific areas and activities within the woodland.

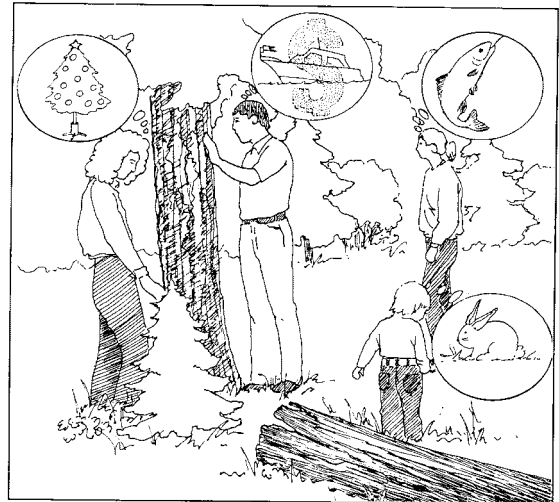

Some examples of goals and objectives for your woodland might be:

Goal	Objective
Investment for future resale. Have a nest egg to fall back on.	Improve the property's appearance and increase the property value. Manage to improve timber values.
Supplement income. Generate revenue to pay for taxes and for other family needs (child's university or retirement) Provide employment for family members or others become self sufficient	Create forest land based business. Manage for timber production, agroforestry, ranching, and/or commercial recreation, tourism and/or education. Sell gravel, lease land. Produce firewood or lumber or fence-posts or Christmas trees or botanical products for own use and/or sale.
Practice conservation and keep the woodland natural	Manage for biodiversity and wildlife habitat. Restore damaged ecosystems. Survey and document all ecosystems on the property. Reforest denuded areas and marginal land.
Produce high quality timber	Establish optimal management regimes and practice intensive silviculture from reforestation through to harvest. Create a specific timber profile (species and grade) over the rotation.
Provide a source of water	Maintain and protect riparian areas, streams, wetlands and lakes and aquifer recharge zones. Maintain forest cover.
Increase wildlife habitat for...(your species preference)	Manage for (specified) forest conditions to create habitat conditions, increase the number of wildlife trees, diversify species composition.
Learn about forestry through practice Practice a woodlot lifestyle and try your own ideas Create a legacy for my kids	Plan and carry out own management activities and involve family members. Take a master woodland manager course Join a woodlot association Take part in extension activities and field trips
Provide outdoor learning and recreational opportunities for family and friends	Identify and develop facilities (trails, campsites, blinds) for fishing, hiking, camping, cycling, horseback riding, cross-country skiing, hunting, bird and wildlife watching
Reduce property and income taxes	Qualify for managed forest land classification. Learn about tax and estate planning. Set up proper business and tax structure.

There are no right or wrong goals, only your own goals. Recognise that your goals and objectives will change over time as your needs, interests and circumstances change. Some goals and objectives may be mutually achievable while others will conflict but don't worry about this—setting goals helps you to clarify and prioritize your interests and activities. The selection of your goals and objectives deserves careful consideration since they will shape your plan and all the activities on the woodland for many years to come. Document your goals and objectives in your management plan. Use your own words.

2. Conduct an Inventory

In order to finalize your personal goals and begin to develop plans for your woodland, you need to know what is in the woodland, what values it is producing now, what it is capable of producing, and what limitations there may be to production of those values. This will mean either conducting an inventory of the land and its resources, or carefully reviewing already existing information.

Doing an inventory is a great way to learn about your land and notice things that are there but that you may have never recognised before. You should design your inventory with your goals in mind in order to make sure you collect the information most needed. Your inventory could also take into account any indicators¹ that you want to keep track of over time in order to monitor your progress and the sustainability of your management. Your inventory will need to consider such things as:

- the current forest cover and ecological communities (extent, tree species, numbers, ages, heights, diameters, volume, growth, value and grade, health factors, vegetation, streams and wetlands, ecosystems)
- site factors (site quality, soils, drainage, terrain, rock outcrops, gravel deposits, sensitive areas)
- infrastructure (boundaries, fences, roads, trails, campsites, easements)
- the presence of other resource values (wildlife, water, recreational features, botanicals)

In addition to telling you what you have, your inventory will act as an important record of what you had when you started. This will allow you to make future comparisons to see how your forest has changed and to monitor how successful you have been in meeting your goals. How to do an inventory is discussed fully in the inventory chapter.

Your Forest Management Plan should contain a brief summary of your inventory information. Inventory information is summarised in various ways including descriptions of values and resources, maps showing locations of your forest cover, woodland features and infrastructure, and tables summarising measured data by stand type or management area. Summarising and organising this information is important so that it is readily accessible for subsequent activity planning and in order to make future comparisons and updates to the management plan.

¹ The international system for monitoring sustainability of forest management (adopted by Canada) involves the identification and measurement over time of specific indicators as a way for a forest manager to demonstrate how they are sustaining various forest values. The Canadian Council of Forest Ministers have adopted an international set of criteria and indicators for use at the National level and these can be used as a guide for application at the local woodland level. See section 'Recommended References.'

3. Assess Your Management Options

Once you know what you have in your woodland and what it is capable of producing, you will be ready to finalise your overall objectives for your woodland, identify your **management options** and develop a **management strategy**. Management options represent the range of potential and alternative management regimes, approaches, actions, and techniques available to achieve your woodland management goals. Your strategy will represent the overall plan for achieving the goals.

The inventory will help you ground your expectations in reality and help to prioritize your list of goals, objectives and preferred options. Practical considerations (operational feasibility), financial considerations (cost and return on investment), woodlot conditions such as age of your forest, and the biological/ecological characteristics of the site will determine what is possible. In some cases you may need to modify your preliminary goals (e.g., by reducing your income expectations) to align more closely with the capabilities of your woodland.

This is also a good time to consult a professional expert for assistance and advice in choosing your management options as a mistake at this stage could prove to be costly later on. Record your chosen management strategy and your rationale.

4. Divide Your Woodland Into Management Areas

To assist planning, it can be useful to divide the woodland into areas that are similar in terms of how they are to be managed. Each **Management Area (MA)** is comprised of stands that are similar enough in species, age, stocking and site characteristics (soil, terrain, etc.) that they can be treated as one unit. Management areas can also consist of areas of your woodland that you wish to manage for other values, such as wildlife habitat, riparian protection or visual aesthetics.

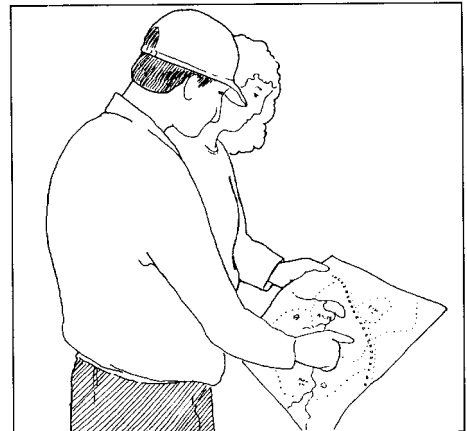

5. Identify Short-term Objectives

Once the management areas have been defined, you can identify objectives for each of them, such as whether you plan to manage an area as even-aged or uneven-aged, conservation or agroforestry and the products you plan to produce (e.g., sawlogs, firewood, botanicals, grazing). These objectives should be consistent with your goals and should focus on what you need or intend to do in the management area over the short term (five years).

These objectives will, in turn, set the stage for the scheduling of specific management activities, such as road building, harvesting, planting and stand tending treatments that you intend to follow.

6. Schedule Short-term Management Activities

Your long-term vision for the woodland will be implemented by your shorter term management activities, which you have developed for each Management Area on the woodland. This process is called a activity plan.

Your activity plan is the ‘meat’ of your Forest Management Plan and sets out the schedule for all operations that will take place on the woodland over the (*five-year*) period. It provides the detailed steps and activities you plan to undertake on a year-to-year basis. The activity plan describes:

- *What will be done:* road construction, harvesting, stand tending, reforestation, etc.
- *Where it will be done:* Management Area – location
- *When it will be done:* year, season
- *How it will be done:* methods, equipment, treatment, special guidelines
- *Who will do it:* owner, manager, contractor or volunteer group.

It is also a good idea to include an estimate of the cost for each activity, and where the money will come from, to make sure that the money required for the activities planned is available when needed.

Specific modifications to timber practices to enhance non-timber resources such as wildlife, recreation and aesthetic values are noted in the activity plan (e.g., the selection of silviculture systems, harvesting methods, and the amount of timber and area from which it is cut). Where special projects, independent of timber management activities, are under-taken to enhance other resource values (such as the building of a weir or fish-raising pond), they should also be described in the activity plan. Activity plans are usually summarized in a table form, and accompanied by a map showing proposed roads, cut blocks, treatment areas and timing.

It is also important to include some flexibility into your activity plan to allow for unplanned circumstances (e.g., change in markets, weather). Identify contingencies in case you are not able to follow through with an activity. This is especially important for Forest Management Plan prepared for tax purposes. Make sure there is enough flexibility in the plan so that you can not be penalised for not achieving all planned activities.

The activity plan is revised on an annual basis to reflect what has been done and provide new detail for the upcoming year. The current year will have the most detail and is known. Subsequent years in the plan will have a little less detail but will gradually come in to focus as they move up in the queue.

7. Define Your Management Standards and Guidelines

It is a good idea to identify performance standards to be met in order to achieve your goals and objectives. It is important that these be set out clearly at the start to guide you and others who might be involved in carrying out activities on the woodland.

Performance guidelines are often prescribed for things such as:

- acceptable regeneration delay to reforest the land
- frequency of regeneration surveys and assessments to determine adequate stocking
- acceptable stocking levels for regeneration
- spacing in juvenile stands
- acceptable slash levels for fire hazard reduction and regeneration

- environmental protection during logging (e.g., soil conservation, stream and riparian protection, road construction and stream crossing standards, harvest standards for rutting, damage to residuals, site clean-up).

There is a lot of good information on management standards available from a variety of sources including the provincial government (e.g., Forest Practices Code guidebooks), the private forest land owners association, from local woodlot associations, professional foresters, and Ministry of Forests offices. In general, it is recommended that you refer to provincial guidelines for species selection and stocking standards, as well as for road construction and harvesting practices.

8. Monitor Your Activities and Progress

“If you don’t measure, it you can’t manage it.”

Planning doesn’t stop with the production of a Forest Management Plan. You will want to keep track of how well the plan is being followed, and whether or not your management activities are achieving the intended results. Use the indicators established at the outset of your plan as the basis for your periodic measurements. Some things you will need to monitor on an annual basis (area harvested, timber produced, stream crossings, regeneration success) while other indicators will only need to be measured every five to ten years or more (stand growth and yield, progress towards long-term goals).

As the character of your woodland and your needs change, the Forest Management Plan must be updated to reflect these changes and provide clear direction to operations on the ground. It is a good idea to review your Forest Management Plan annually, and update it as necessary (at least every five years).

It is important that you understand and are comfortable with your Forest Management Plan. It should cover all aspects of what you want from the woodland, and provide a realistic set of activities for achieving these. The Forest Management Plan must work for you.

Forest Management Plan

Woodland Description

Owner
Location
Access
Features (Terrain, Soil, Water, Wildlife, Recreation)
Overview Map

Goals and Objectives

Personal Goals and Objectives

Inventory

Timber Inventory
Yield Calculation
Other Inventories

Forest Management

Management Area and Map

Short-Term Activity Plan

Silviculture Activities
Harvesting Activities
Access Activities
Resource Management Activities
Equipment
Contractor/Operator
Financial and Marketing Plan

Management Standards

Protection

Health
Fire

Monitoring and Records

Chronicle / Activity Diary
Management Records

You've Done It

If you've followed these steps and written everything down then you should be pretty close to having a Forest Management Plan for your woodland. A few final things you could add to it to round it off are appendices for specific information or references, a glossary of forestry terms and information commonly used such as contacts and a list of legal requirements.

For reference, a template and a sample Forest Management Plan for the Treharne property follows. It provides an example of how the information outlined in the steps above might be presented.

Sample Forest Management Plan

A Sample Forest Management Plan for District Lot 2345: Owners, Sylvia & Rex Treharne

Woodland Description

D.L. 2345 is located approximately 25 km southwest of Cranmore on the White Lake Road. The area is 140 ha and the White Lake Road runs through the parcel. The woodland is adjacent to and east of the Treharne's permanent residence. The resource values on the area are summarized below.

The area also has a moderate capability for deer and a variety of fur-bearing animals, songbirds, waterfowl and several families of grouse use Management Areas 4 and 5.

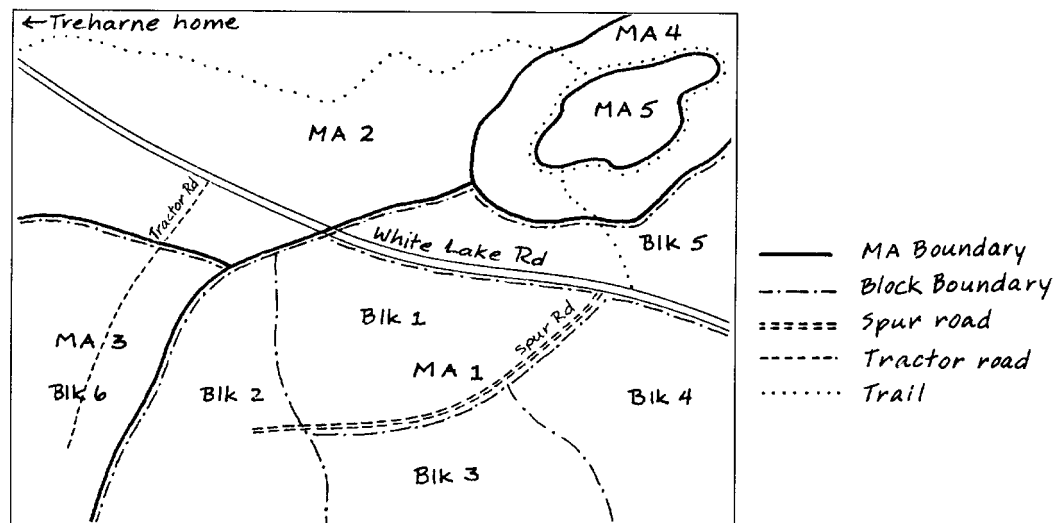

Goals and Objectives

- to supplement our annual income by approximately **\$5000** for the next 8 to 10 years to finance our children's education; then provide periodic income for our retirement
- to increase the value of the property over the long term
- to provide recreational opportunities for family and community groups

- to qualify for the ‘managed forest land’ classification and obtain a lower tax assessment.

Inventory

A timber inventory was conducted and a sustainable harvest rate was calculated at 350m³/ha per year.

- Conduct wildlife habitat inventory.

Forest Management

To manage the overall area for the continuous production of commercially valuable tree species and to regulate the rate and timing of harvests to achieve personal goals.

- Management Area 1 will be harvested and reforested entirely over a 10-year period, with annual harvests of approximately 4000 m³. This might be adjusted to take advantage of market conditions. The main products will be sawlogs. Care will be taken to minimize the impact on aesthetic values along White Lake Road.
- Management Area 2 will be improved by commercial thinning, eventually harvested for sawlogs and reforested.
- Management Area 3 will be developed as a Christmas tree plantation.
- Management Areas 4 and 5 will be developed for recreational and wildlife habitat purposes.

	Forest Type	Area (ha)	Vol. (m ³)	Age	Height Class	Stocking Class	Site Class	MAI (m ³ /yr)
MA 1:	F C	70	40 000	140	32	1 (mat)	M	3.5
MA 2:	F (C)	40	-	45	26	0(imm)	M	3.5
MA 3:	NC Br	15	-	-	-	-	M	3.5
MA 4:	Ep (C)	10	-	18	18	0(imm)	M	3
MA 5:	Swamp	5	-	-	-	-	-	-

Short-term Activities 2003–2007

The five-year activities for each Management Area are summarized as follows:

Silviculture Activities:

- plant Douglas-fir seedlings as Christmas tree stock in MA 3; manage with a 7 to 10 year rotation.

Harvesting Activities:

- harvest all of MA 1 by small clearcuts over 8 to 10 years; plant after logging
- conduct periodic commercial thinning in MA 2 after MA 1 has been completely harvested.

Access Activities:

- construct a road into MA 1, south of White Lake Road to provide logging access
- construct tractor access into MA 3 for management access to the Christmas tree plantation.

Resource Management Activities – Recreation:

- construct a dual-purpose (cross-country ski and mountain bike) trail from the Treharne residence through MA 2 to MA 4 and MA 5, with a connecting link to the White Lake Road.
- enhance MA 4 and 5 for wildlife and recreational values; construct a waterfowl blind at the pond site for Canada geese and other species.

Five-year Activity Plan 2003–2007					
Activity	Timing	Area	Location	Description	Work
Road Construction	2003 summer	MA 1	Spur A	Construct spur road 3.5 m wide surface with gravel as needed	Contract
	2003 summer	MA 3	Spur B	Construct tractor access to Christmas tree plantation	Owner
Harvest Cut	2003 summer	MA 1	Block 1	Clearcut 7 ha, hand fell, skid with tractor	Owner
	2004 summer	MA 1	Block 2	Clearcut 7 ha, hand fell, skid with tractor	Owner
	2004 fall	MA 1	Block 1	Burn slash	Owner
	2005 summer	MA 1	Block 3	Clearcut 7 ha, hand fell, skid with tractor	Owner
	2005 fall	MA 1	Block 2	Burn slash	Owner
	2006 spring	MA 1	Block 4	Clearcut 7 ha, hand fell, skid with horses	Owner contract
	2006 fall	MA 1	Block 3	Burn slash	Owner
	2007 summer	MA 1	Block 5	Clearcut 7 ha, hand fell, skid with horses	Owner contract
	2007 fall	MA 1	Block 4	Burn slash	Owner
	Planting	2004 spring	MA 3	Block 6	Brush removal with brush blade on tractor, plant 2+1 bareroot D-Fir for Christmas tree production
2005 spring		MA 1	Block 1	Plant D-fir, cedar, 2+0 plug stock	Jr. Forest Wardens
2006 spring		MA 1	Block 2	Plant D-fir, cedar, 2+0 plug stock	Jr. Forest Wardens
2007 spring		MA 1	Block 3	Plant D-fir, cedar, 2+0 plug stock	Jr. Forest Wardens
Stand Improvement	2005 –2007	MA 3	Block 6	Christmas tree shearing, protection activities	Owner / family
	2004/05	MA 2,4,5	see map	Construct x-country/bike trail from residence to MA 4 and around swamp/pond	Volunteer / family
	2006 summer	MA 1,5,6	see map	Construct trail from White Lake Road to connect to trail around swamp	Volunteer / family
	2006 fall	MA 4		Construct waterfowl blind	Volunteer / family
	2006 –2007		Review and update Forest Management Plan and 5-year Activity Plan		

Management Standards

- regeneration delay will be a maximum of 5 years following harvesting
- reforestation surveys will be conducted at 2 and 4 years following logging to provincial methods and standards
- provincial species selection guide and stocking standards will be followed
- survival assessments of plantations will be conducted 1 and 3 years after planting using provincial methods and standards
- no skidding equipment will be used within 30 metres of White Lake Road, and selective cutting within that strip will be carried out to maintain aesthetic values.

Protection

- check Area 2 for root rot.

Monitoring and Records

Recommended References

Small Woodlands Program of BC

A comprehensive 'Small Woodlands Library' is available on the web [www.swp.bc.ca]

Canadian Forest Service

Pacific Forestry Centre

506 West Burnside Road

Victoria, BC, V8Z 1M5, tel.: 250-363-0600, fax: 250-363-0775

[www.pfc.cfs.nrcan.gc.ca]

Publications on many forestry-related topics are available on request from the on-line bookstore at [<http://bookstore.cfs.nrcan.gc.ca>]

Hilts, S. and P. Mitchell, 1999. *The Woodlot Management Handbook*. Firefly Books, Willowdale, 282 pp. (highly recommended, available from Small Woodlands Library)

Wiskel, B., 1995. *Woodlot Management*. B., Lone Pine Publishing, Edmonton, 134pp. (highly recommended, especially for woodland owners in northern BC)

Baughmann, M. et al, 2000. *Woodland Stewardship, A Practical Guide for Midwestern Landowners*. Regents University Minnesota, summary, (available from Malaspina College)

Sanders, P., 2002. *How to Start Managing your Farm/Woodlot*. private course developed by Peter Sanders. (available in summary from SWP Malaspina College)

Heiligmann, R. *Forest Management – Developing a Plan to Care for Your Forest*. Extension brief, Ohio State University Extension (available from SW Malaspina College)

Higman, S. et al, 1999. *The Sustainable Forestry Handbook*. IIED/SGS, Earthscan Publications, London UK (ISBN 1 85383 599 4)

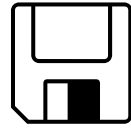

Silvicultural Systems

Stand Management

In this chapter...

Silvicultural Systems	72
Even-aged Systems	72
Uneven-aged Systems	79
Systems with Reserves	83
Recommended References	85

.....

Silvicultural Systems

Harvesting is more than just cutting trees. It is part of the overall management strategy by which you plan to achieve your short-term and long-term objectives. The process by which a forest is tended, harvested and replaced is called a silvicultural system. These are classified according to the method by which you remove the mature crop and establish a new one. Each of these systems represents a strategy for the complete cycle of the stand. The silvicultural system you chose will be based on your own management objectives and the characteristics of the forest you have, and the forest you wish to create.

In managing the forest for timber production, forest land owners try to emulate the clearing and regeneration phases carried out in nature. *Clearcutting* mimics some of the stand establishing processes that follow wildfires; *shelterwood* forests have been historically created by intense ground fires that cleared the understorey and provided a seedbed; *selection* stands naturally evolve through individual or small groups of tree mortality caused by natural agents such as disease, insects or windthrow.

These three silvicultural systems—clearcutting, selection and shelterwood—are the primary methods used in British Columbia. The silvicultural system you select for an area will depend on the nature of the stand to be harvested, the kind of trees you want for your next crop, and the method of regenerating the new crop.

Even-aged Systems

Even-aged systems include the general categories of clearcut, patch cut, coppice, seed tree and shelterwood silvicultural systems. These systems produce generally even-aged stands, except for the irregular shelterwood system. Even-aged systems can have a variety of stand structures in the short term. In the long term, even-aged stands tend to have generally similar age and size structures, although this may be modified by retention of reserves, heterogeneous cutting patterns or variable species composition.

Characteristics typical of even-aged stands are:

- a narrow range of tree ages (generally less than 20% of the length of rotation),
- regeneration established relatively synchronously within a short period following a major disturbance,
- one or two distinct and well-represented age classes
- generally an even canopy (although even-aged species mixtures can form two- or multi-layered stands).

The even aged forest may lack some of the visual and ecological characteristics of the more varied, uneven aged structure, though this may be regained during subsequent stand management activities.

Clearcut Systems

A *clearcut system* is defined as a silvicultural system that removes an entire stand of trees from an area of one hectare or more and greater than two tree heights in width, in a single harvesting operation. A new, even-aged crop is obtained either by planting, natural or advance regeneration, and/or direct seeding.

While clearcutting has developed many negative social connotations associated with size, visual quality, impact on landscape ecosystems and some wildlife, it is unlikely that many of the potential drawbacks associated with clearcutting would develop within small-scale woodland operations. Due to the size of private woodlands, any planned clearcut blocks can be small and irregular shaped, thus negating many of the potential drawbacks. When laying out clearcut blocks, locate edges at windfirm boundaries, forest type changes, breaks in the visual landscape or at roads. The reasons for not clearcutting would more likely be based on the personal goals of the landowner than on environmental reasons.

Generally, most or all trees within a unit are clear-felled at one point in time at the end of the rotation.

Regeneration occurs within a short period after harvest. Specific regeneration strategies, such as planting, natural regeneration or retention of some advance regeneration, cannot be termed variants of the clearcut system, but simply different regeneration methods in the clearcut system.

With the clearcut system, the opening size and dimensions created (greater than one hectare and greater than two mature tree heights) is generally large enough to limit significant microclimatic influence from the surrounding stand.

The clearcut system has two variants:

- the clearcut system
- clearcutting with reserves.

Patch Cut Systems

The *patch cut system* is defined as a silvicultural system that creates openings less than one hectare in size, which are to be managed individually as distinct even-aged stands. The choice of methods employed under this system to regenerate harvested areas does not depend on shelter incidentally provided by the surrounding uncut stand. A new, even-aged crop is obtained by planting, natural or advance regeneration, or direct seeding.

The patch cut system has two variants:

- the patch cut system
- patch cutting with reserves.

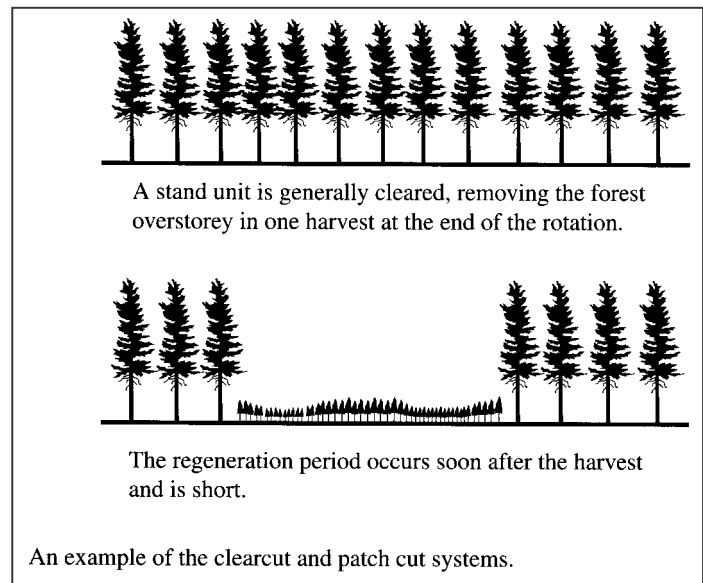

Seed Tree Systems

A *seed tree system* is defined as a silvicultural system in which selected trees or tree groups are left standing after the initial harvest, to provide a seed source for natural regeneration. After natural regeneration is achieved, the seed trees may or may not be removed.

Seed trees should be of good form, of the preferred species, and be windfirm. You should leave more trees for those species with heavier seed such as western white pine and grand fir on the coast, and ponderosa pine in the interior. Lighter seeds such as western hemlock and lodgepole pine will not require as many seed trees left in the block.

In some cases, the seeds or establishment cut is preceded by a preparatory cut, as described for shelterwood systems below.

Uniform Seed Tree System

In a uniform seed tree system, *individual trees* are excluded from harvesting and tend to be uniformly distributed throughout the stand unit.

Uniform seed tree system

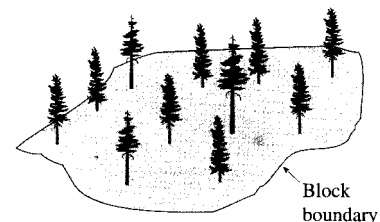

Grouped Seed Tree System

In a grouped seed tree system, *groups of trees* are excluded from harvesting. For seed dispersal, the individual groups of trees should be uniformly distributed throughout the stand unit, but an irregular distribution may be necessitated by the natural distribution of the most desirable seed trees on the site.

Grouped seed tree system

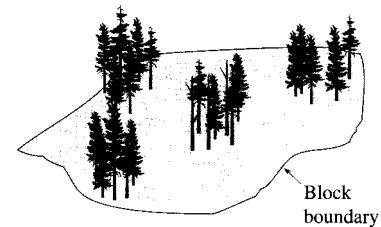

Examples of uniform and grouped seed tree system variants.

Shelterwood Systems

The **shelterwood system** is defined as a silvicultural system in which mature trees are removed in a series of cuts to achieve a new even-aged stand under the shelter of remaining trees.

Shelterwood systems remove successive components of the existing stand in a series of cuttings. Regeneration may be planted or natural regeneration from seed, or pre-established advance regeneration from the pre-harvest stand. Specifically, the intent of these cuttings is to:

- provide shelter with sufficient overstorey trees to ameliorate microclimatic extremes or other potentially adverse conditions on the site, promoting establishment of an even-aged stand under leave-trees from a mature stand
- potentially provide seeds and an environment (shelter) for natural regeneration
- provide site occupancy and volume increments by retaining mature trees during the regeneration phase.

There can be up to three cut phases in a shelterwood or seed tree system:

1. *Preparatory cutting*: to prepare the stand for reproduction. Openings are created to let in sunlight and rainfall to speed the decomposition of humus, encourage crown development, and start to develop some windfirmness in the trees that will be retained for the final crop. Trees removed are from the lower crown classes. This cutting is important in dense stands and is often accomplished as thinnings.
2. *Seed cutting*: to open enough growing space to establish regeneration of the new crop. The seed cutting is conducted as a single cutting operation (as compared to selection cutting) and is timed for a year when seed of the desired species is abundant. It is possible to enhance seed production by partial girdling on some species. The trees removed are the least desirable intermediate and co-dominants and all non-desirable species.
3. *Removal cutting*: to make way for the new crop. Removal cutting is usually done within a decade of seed cutting, once the new crop is established and in need of more growing space. Ideally, it is carried out to remove the old crop at the rate at which the new crop fills the site. These remnant dominants can be removed if you feel they are having a negative impact on the new regeneration. You may decide to leave them for non-timber values such as aesthetics, wildlife habitat or to continue to accumulate volume at a steady but slower rate. These can also be removed just before the new crop requires juvenile spacing. The inevitable damage to the regeneration can then be addressed in the spacing treatment.

The following sections describe the six different variants of shelterwood systems.

Uniform, strip and group shelterwood systems are identified by the spatial arrangement of leave-trees. Irregular, natural and nurse-tree shelterwood systems differ by the timing of overstorey removal. Nurse-tree shelterwood is used to manage different species (often shade-intolerant and -tolerant) in different canopy layers.

Uniform Shelterwood System

A uniform shelterwood system consists of individual leave-trees distributed relatively uniformly throughout the stand unit.

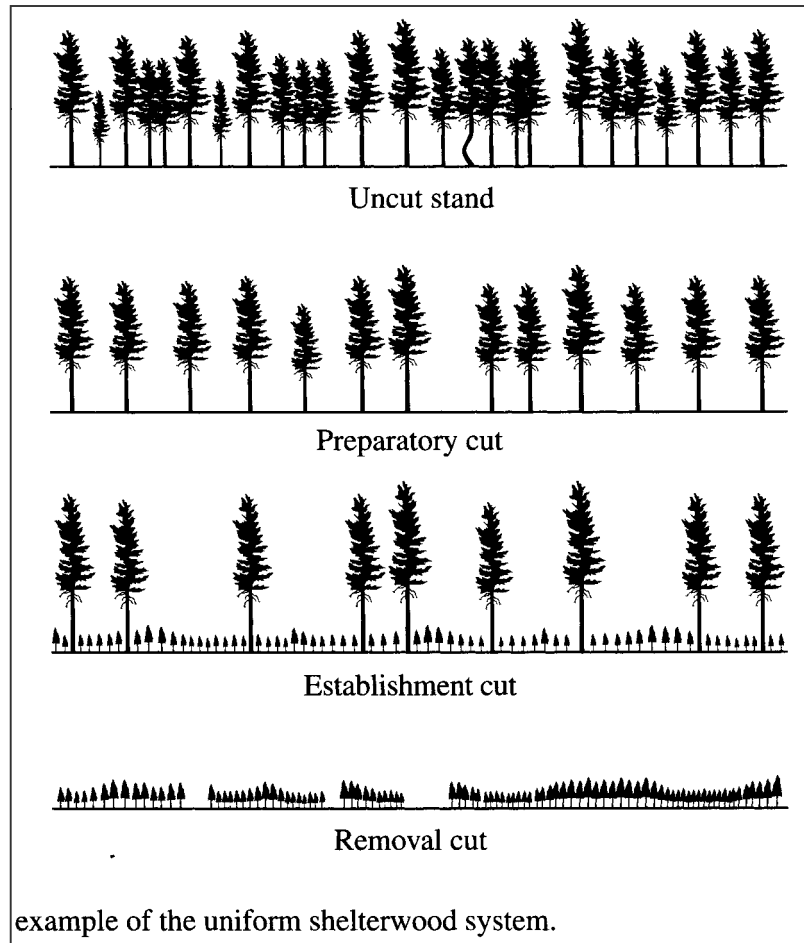

Strip Shelterwood System

A strip shelterwood system involves a series of progressive, usually linear cuts in narrow successive strips, as illustrated.

The basic principles influencing strip orientation include, but are not limited to, minimizing damaging effects on the residual stand (e.g., wind), maximizing or minimizing shading of cut strips by the uncut areas depending on the shade tolerance of the new crop, and accommodating terrain conditions.

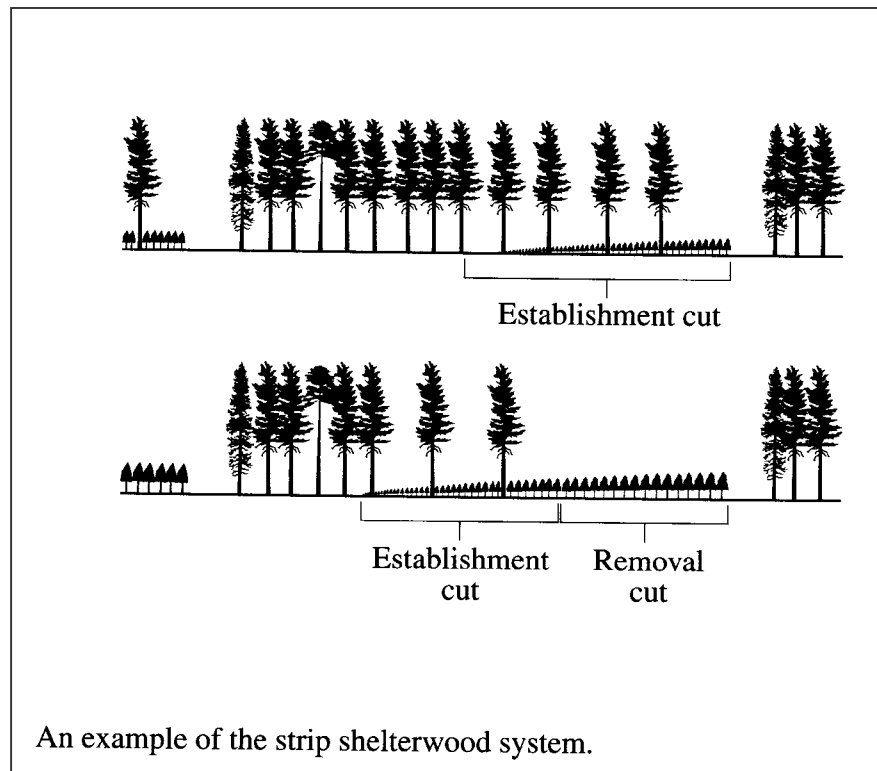

For example, for wind-prone stands, strips in the lee of prevailing storm winds could be cut first, while windward windfirm strips would be left until later stand entries. In areas where drought and excessive daytime heat stress would likely adversely affect regeneration, strips could be oriented east-west to maximize shading of cut strips; in this case, northern strips would be cut first.

Group Shelterwood System

In a group shelterwood system, small openings are created in the stand such that the adjacent trees shelter the new regeneration. The size or density of leave-tree groups will decrease through one or more future stand harvests, until the mature overstorey has been completely removed. Regeneration methods for the final area to be harvested may include natural or artificial regeneration or a combination of both.

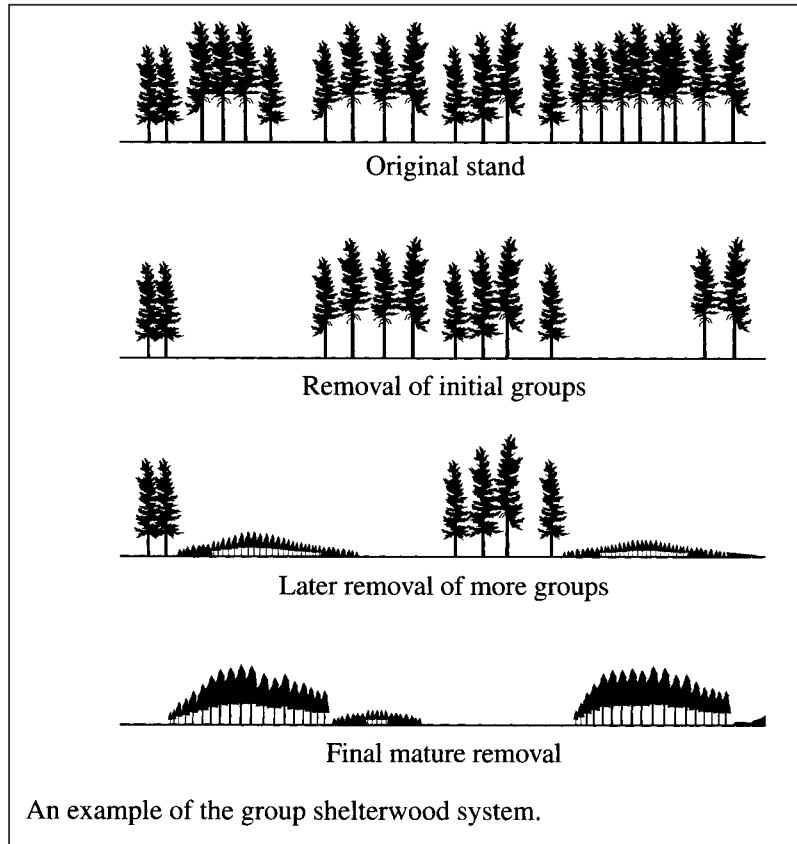

Irregular Shelterwood System

An irregular shelterwood system can incorporate characteristics of other shelterwood systems. The key characteristic of the irregular shelterwood is that, although prompt regeneration is an objective, residual trees are left for long periods beyond the regeneration phase (e.g., from 20% of the rotation to several rotations). Residual trees initiate new age classes of regeneration, accumulate wood volume increment and, if desired, achieve non-timber stand objectives. Due to the protracted retention of leave-trees, the resulting stand is broadly aged and therefore intermediate between an even-aged and an uneven-aged stand. The reserved trees can be left for a defined or indefinite period after the regeneration phase. Both group and uniform patterns of leave-tree retention can be formed.

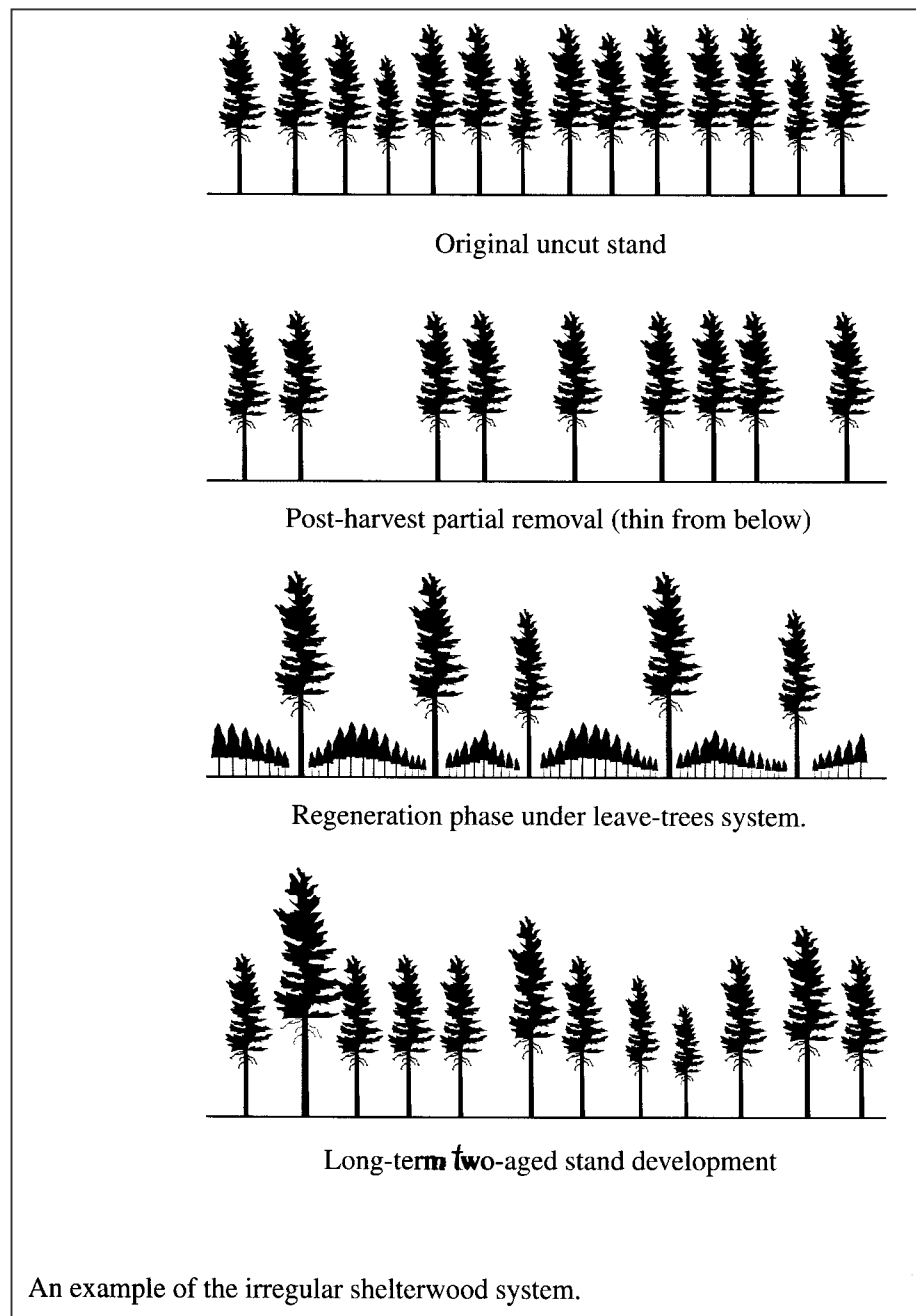

Uneven-aged Systems

Uneven-aged systems refer to the general category of selection silvicultural systems. These systems produce uneven-aged stands. A selection or uneven-aged silvicultural system develops or maintains a mixture of three or more distinct, well-represented age classes. The management goal is to create and maintain the stand and age structure over time. Selection systems, over long periods of time, may convert even-aged stands to uneven-aged stands through several (or many) light stand entries at relatively short intervals of one to several decades.

Selection Systems

Many small-scale woodland operations are located in second growth timber where the stands are still capable of significant increases in growth and value. Selection harvesting is appropriate to many of these stands because of the system's ability to achieve a number of goals. It is used in the interior in mixed stands of Douglas-fir, larch and lodgepole pine. The pine is removed to favour the other two more valuable species. It is being used in second growth stands to simulate old growth winter range conditions for blacktailed deer. It is also being used in parts of the province afflicted with mountain pine beetle. The targeted pines are removed to encourage the regeneration and growth of more vigorous and resistant species.

Accessibility is a key element of the selection silvicultural system. Often this method will require an extensive road and trail system. While the network can have detrimental effects from siltation and increased monitoring, it can also provide access for fire protection, future stand tending operations as well as recreation. Selection systems are most successfully carried out on level to slightly sloping terrain. **The major concern with this system is the potential for damage to the soil and the trees or seedlings remaining on the site.**

This system requires a thorough knowledge of the *silvical characteristics* of the species in the stand. What do they require to establish, grow and thrive? It is also necessary to have a good understanding of the ongoing stand development processes. Where is the stand on the successional (pioneer to mature) stage? Is it a juvenile stand or have some individuals or patches of trees begun to achieve maturity?

General characteristics of *selection systems* include:

- harvesting timber at specified repeated intervals (termed cutting cycles, which are one-third or less of the planned maximum age of the oldest age class of tree managed for timber objectives)
- harvesting single scattered individuals or small groups of individual trees
- encouraging relatively frequent establishment of regeneration in canopy gaps
- encouraging and maintaining an uneven canopy and an uneven-aged stand structure of at least three well-represented age classes
- including intermediate cuttings (juvenile spacing or commercial thinning) in immature age classes, concurrent with the harvest of mature timber or otherwise during the cutting cycle, to meet specified stand management goals.

Single Tree Selection System

The *single tree selection* system is defined as an uneven-aged silvicultural system in which new age classes are created by the removal of individual trees of all size classes, more or less uniformly throughout the stand. Single tree selection systems often have been confused with diameter-limit “high-grading” partial cuts, which focus on harvesting the largest, most valuable tree sizes or species in a stand—a “take the best and leave the rest” approach. Legitimate selection systems, as illustrated in Figure 10, strive to maintain or improve forest quality and health through judicious planned cutting in all size classes—“taking the worst first.”

A single tree selection system removes individual trees or small clusters of trees during stand entries, spaced over relatively short specified time periods or cutting cycles. This system creates or perpetuates the multi-layered uneven-aged nature of the stand by creating very small canopy gaps. At each stand entry, designated trees in certain diameter

classes are cut, leaving behind acceptable stocking of desirable trees in all diameter classes (with room for adding more trees to each diameter class).

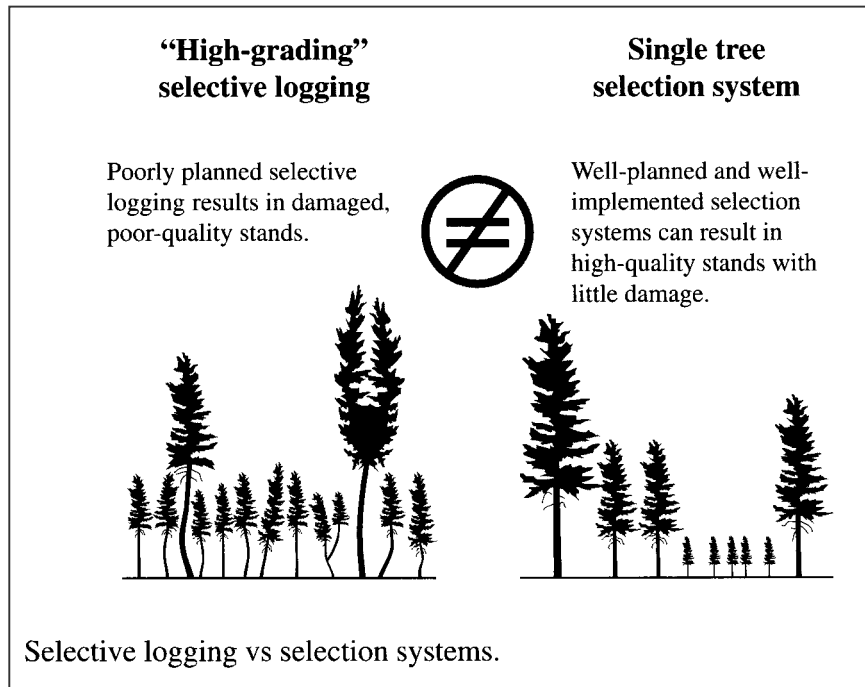

Over the long run, cumulative volume removals from a well-stocked, uneven-aged stand managed under the single tree selection system should balance the average periodic volume increment for the stand over the same time. In addition to controlling volume removal, the selection cuts must maintain or enhance stand structure and characteristics to achieve long-term stand-level management objectives.

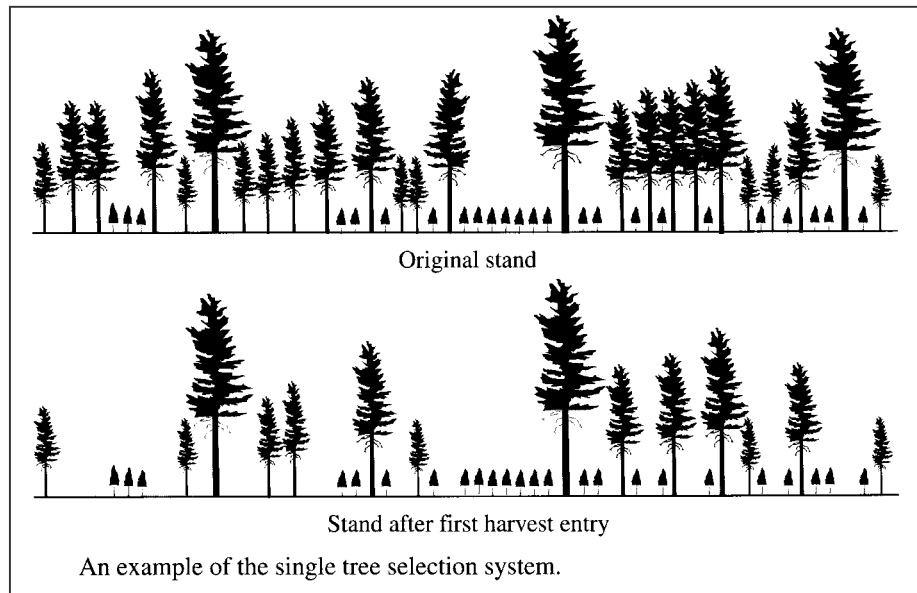

Historically, natural or advance regeneration has been relied upon for selection systems. Planted (artificial) regeneration can also be done, particularly for regeneration of species that may not have a suitable local seed source or reliable seed supply. The specified uneven-aged and uneven-sized structure of the residual stand must meet the objective specified in the prescription.

Group (and Strip) Selection Systems

The *group selection system* is defined as a silvicultural system that removes trees in defined groups to create stand openings with a width less than two times the height of adjacent mature trees, and that manages the area as an uneven-aged stand.

A group selection system has potential for stands that are presently either uneven-aged or even-aged. This system is often used for conversion of even-aged stands to uneven-aged stands, where appropriate.

To regulate the stand-level harvest of a stand under group selection, the total area to be harvested from a stand at each stand entry must be determined. This area is based on the length of the cutting cycle, the planned rotation age of the groups and the percentage of the unit available for long-term management. This method of stand-level cut determination is termed *area regulation*.

As a simple example, in an even-aged stand that has a rotation age of 100 years, 92% of the stand is available for group selection management outside of permanent access structures and group reserves, and the cutting cycle is 25 years. A rotation of 100 years with a cutting cycle of 25 years will support four age classes (25 years, 50 years, 75 years and 100 years old at the end of the fourth cutting cycle).

The percentage of the available area that can be harvested at each stand entry is equal to 92% divided by 4 (age classes), or 23% of the stand area per cutting cycle. The openings can be naturally or artificially regenerated.

Under group selection, each opening created is generally small enough to receive significant protection and shelter from the surrounding stand for the whole area of the opening (two tree lengths or less in diameter).

A modification of group selection is *strip selection*. Narrow strips, of a width less than two times the height of the adjacent mature trees, are progressively cut generally in linear

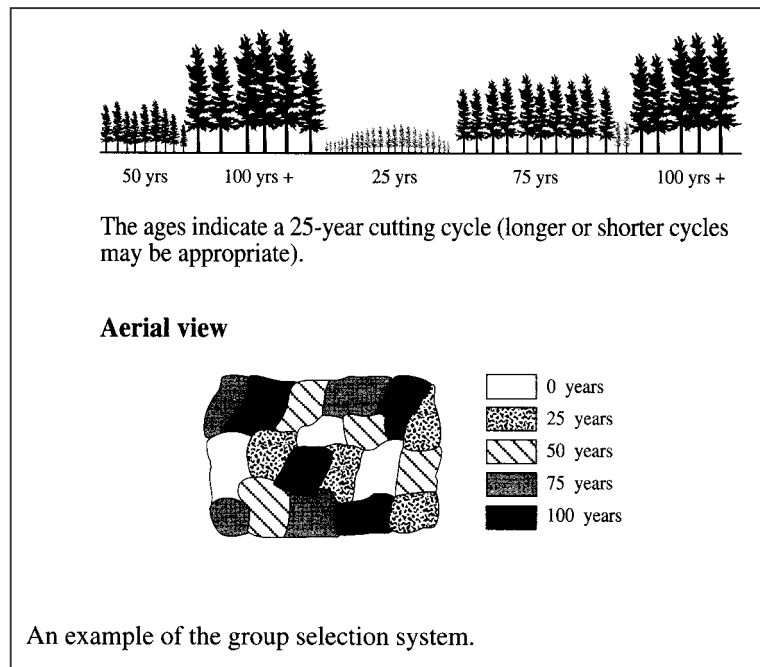

strips distributed throughout the stand. The basic principles influencing strip orientation include, but are not limited to, minimizing damaging effects on the residual stand (e.g., wind), optimizing shading of cut strips by the uncut areas, and terrain considerations.

For example, for wind-prone stands, strips in the lee of prevailing storm winds could be cut first, while windward windfirm strips would be left for later stand entries. In areas where drought and excessive daytime heat would likely affect regeneration adversely,

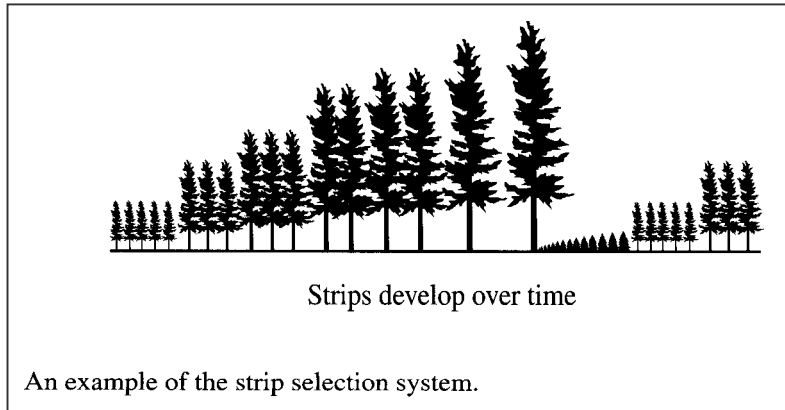

strips could be oriented east-west to maximize shading of cut strips; in this case, northern strips would be cut first.

Thin or sensitive soils can be severely damaged by heavy or repeated traffic, and can result in erosion and

regeneration problems later on. Refer to a discussion of soil characteristics and considerations in the chapters on “Forestry Basics” and “Forest Access.” Wounds to the stems and roots of standing trees can create pathways for the entry of insects and disease. Damage of this type can be minimized by careful, advance planning of harvests and close supervision of contract work during these phases.

In selecting the trees for removal, the goals are to generate revenue, promote regeneration, and enhance the growth of the remaining trees. Therefore, in addition to extracting valuable, mature stems, the low quality or poorly formed and slow-growing trees should also be removed so that the seed source for regeneration is of the preferred crop species. So long as a tree is healthy and growing it is increasing in value. It makes sense, therefore, to retain some of the larger, higher value stems on site to continue to ‘appreciate’ in value, while removing some of the less thrifty stems to open the area and encourage reproduction. Selection cutting closely resembles thinning since it improves growing conditions and future returns while harvesting some of the mature timber for returns now.

Systems with Reserves

Some silvicultural systems have characteristics additional to those listed previously—system variants (including reserves) may be appropriate.

Stand-level reserves are defined as single trees, identified uncut groups or a mixture of both, retained for a defined period or indefinitely to meet objectives other than regeneration.

Reserves can be uniformly distributed single trees or small tree clusters, large well-defined groups, or a mix of two reserve types. Reserve trees are not intended to provide any more than incidental seed or shelter to the regeneration stand and site. Use of reserves can be compatible with any silvicultural system, under appropriate stand and site conditions.

Seed tree system with reserves for wildlife trees

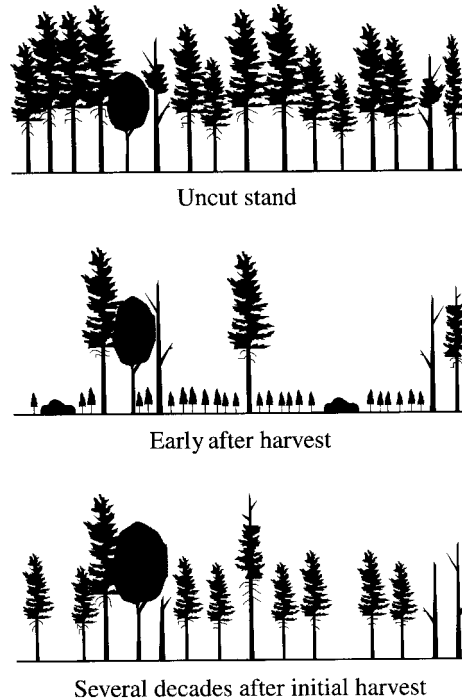

An example of a system with reserves.

Variable Retention

The variable retention system was developed only recently in BC to try to address ecological issues in the design and layout of harvest areas. The variable retention system is not a distinct silvicultural system but borrows aspects of both even-aged and unevenaged systems. The formal definition requires that a minimum of 50% of the area of the cutblock be within the 'forest influence'² or one tree length from an edge. Irregular boundaries and the retention of dispersed trees or different sized groups of trees are intended to provide 'forest influence,' structural diversity in the, recruitment of future coarse woody debris, habitat and cover for birds and mammals, and to serve as lifeboats for the colonization of the new stand with the flora and fauna (bryophytes, soil microfauna, canopy insects, forest floor plants) associated with the previous stand. Regeneration of areas designed for variable retention is usually even-aged arising from either natural seed or planting.

² Forest influence pertains to the microclimate effects and more diverse regeneration and habitat zone associated with the edge of the forest.

Recommended References

Small Woodlands Program of BC

A comprehensive 'Small Woodlands Library' is available on the web [www.swp.bc.ca]

Canadian Forest Service

Pacific Forestry Centre

506 West Burnside Road

Victoria, BC, V8Z 1M5, tel.: 250-363-0600, fax: 250-363-0775

[www.pfc.cfs.nrcan.gc.ca]

Publications on many forestry-related topics are available on request from the on-line bookstore at [<http://bookstore.cfs.nrcan.gc.ca>]

Ministry of Forests, Production Resources, 4th Floor - 722 Johnson Street, PO Box 9523, Stn. Prov. Gov., Victoria BC V8W 9C2,

[www.for.gov.bc.ca/tasb/legsregs/fpc/fpcguide/guidetoc.htm]

Forestry Continuing Studies Network

Silvicultural Systems Workshop

2665 East Mall, Vancouver, BC V6T 1W5

tel.: 604-222-9157, fax: 604-222-1730

Email: inquire@fcsn.bc.ca

[www.fcsn.bc.ca]

Forestry Canada (FRDA): *Montane Alternative Silvicultural Systems (MASS)*, Proceedings of workshop in Courtenay 1995, FRDA report 238

Forestry Canada (FRDA): *Are European Silvicultural systems and Precedents Useful for BC Silviculture Prescriptions, 1996*, FRDA report 239

Smith, David, 1993. *Silvicultural Systems Program, Discussion Paper*. Forestry Canada (FRDA); FRDA discussion Paper

Oregon State University Woodland Workbook.

Publication Orders, Extension and Station, Communications, Oregon State Univer.,

422 Kerr Administration, Corvallis, OR 97331-2119,

fax. 541-737-0817.

[www.orst.edu]

Washington State University

[<http://pubs.wsu.edu>]

Stathers, R.J., T.P. Rollerson, and S.J. Mitchell, 1994. *Windthrow handbook for BC forests*, BC Ministry of Forests Res. Program Working Paper 9401.31p

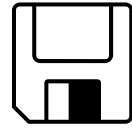

Commercial Thinning

Stand Management

In this chapter...

Introduction	88
Why Thin?	88
When to Thin?	89
How to Thin	89
Thinning Equipment	93
Recommended References	94

.....

Introduction

There are many terms we use to describe operations that remove some of the trees from a stand. While they may look similar, the purpose, scope and results differ greatly.

In the “Stand Tending Basics” chapter, we discuss early thinning treatments called *juvenile spacing or pre-commercial thinning*, undertaken when the stand is young and the felled stems are of a non-merchantable size.

In the “Silvicultural Systems” chapter, we discuss partial harvest systems called seed tree, shelterwood, or selection cuts which are designed to foster the regeneration of the stand.

Between the silvicultural practice of juvenile spacing and the new stand initiating partial cuts comes *commercial thinning*, a density management operation that is a bit of both. The objectives of commercial thinning are not related to reforestation objectives. A commercial thinning entry is designed to capture imminent mortality due to competition, and to modify the stand so that continued stand development will enhance the quality or growth of the remaining trees. This operation is called *commercial thinning* because as it is generally applied to older stands, the trees removed by the thinning are usually large enough to have commercial value.

Why Thin?

The effects of juvenile spacing do not last forever. Eventually, the root systems and crowns of the young trees will once again begin to compete. As the crowns close together, the number of trees that can occupy the site to best advantage decreases. It is time again to remove some of the less desirable trees to make room for development of the crop trees. Since the objective of thinning is to maintain or improve the rate of growth of crop trees, the timing of thinning is determined by when the annual growth rate of these trees begins to slow.

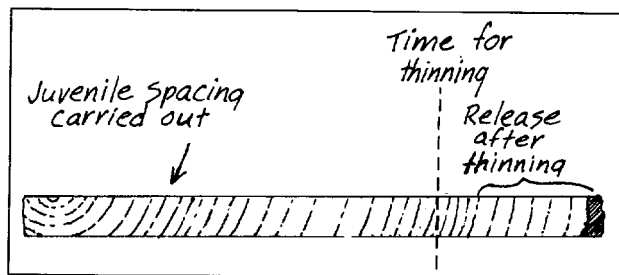

You can check growth rates by taking increment cores from your trees. Watch for early signs of reduced annual growth, visible as narrowing in the growth rings closest to the bark. This may indicate the need to reduce competition. Ideally, in an intensively managed stand, thinning treatments would be carried out in anticipation of competition, so that crop tree growth would never slow down.

A stand can be thinned several times during its life to maintain growth rates at their optimum and recover wood that would otherwise be outcompeted and die. At the time of each thinning, the trees of the stand can be separated into three categories:

- the final crop trees (most important category)
- trees that will be removed in later thinnings, but that are kept in the meantime to fully occupy the available growing space; as the stand grows and the crop trees get larger, these trees will be removed to allow the final crop tree to fully occupy the site
- the third category consists of the trees to be removed in the current thinning.

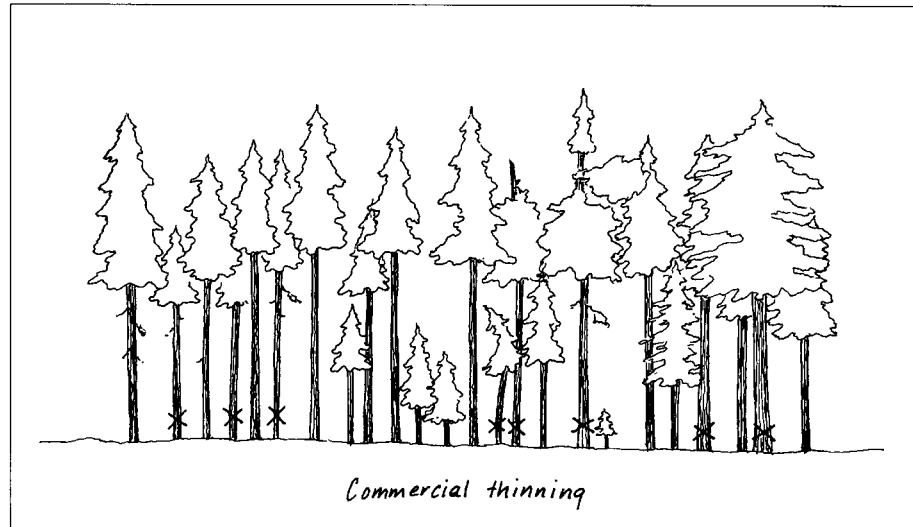

When to Thin?

Commercial thinning is carried out when the growth of the stand starts to slow down due to competition, and when the volume of the excess stems to be removed is sufficient to make the operation profitable. Tree size affects merchantable volume recovery as well as logging costs. As a rule of thumb, average minimum stand diameters for industrial commercial thinnings are 25 cm on the coast and 20 cm in the interior. Small-scale operators will likely be able to carry out profitable commercial thinnings at smaller diameters than these, depending on local markets for small wood products and the costs of logging and hauling.

How to Thin

How Do I Select Which Trees to Thin?

The first step in planning a thinning is to select your final crop trees, the trees that you intend to leave behind. Always keep in mind that the purpose of thinning is to create enough growing space in your stand to improve the growth of the trees left behind for the final harvest. This step applies whether you are working with a managed stand or an unmanaged natural stand.

Your *crop trees* should be:

- of the preferred species and highest potential value
- thick-barked species (e.g., Douglas-fir) versus thin-barked species (e.g., hemlock or true firs) to minimize crop tree damage
- longer lived species or species with greater response potential (e.g., Douglas-fir or larch versus lodgepole pine)
- species with deep roots versus shallow roots.

In mixed stands, such as interior lodgepole pine/larch, select the most valuable species (larch) as the final crop and remove the lesser value species (pine) as commercial thinnings. Check your management plan for further guidance on your species priorities.

The choice between *individual trees* aims for healthy vigorous trees based on:

- large diameter
- dominant or codominant size class
- straight trunk
- healthy crown (with at least a 25% live crown/tree height ratio)
- small branches and long distance between branch whorls.

As with the selection of crop trees at the juvenile spacing stage, the spacing may be varied to allow selection of the best available tree of the preferred species (i.e., it is better to choose the best tree available than to maintain a strict intertree spacing interval).

Guidelines for Thinning:

- ✓ choose stands with a good response potential:
 - medium or good sites
 - little damage from disease, insects, wind, snow
 - final harvest date at least 15 to 20 years away
- ✓ species priority:
 - what can grow best on your site?
 - what species best meets your goals?
 - what insect and disease problems should you consider?
- ✓ crop tree selection:
 - species
 - tree location (especially windfirmness)
 - quality
 - size
 - vigour
 - live crown ratio and crown balance
 - form
 - insect/disease resistance
 - adjacent trees and openings (i.e., spacing of crop trees)

What Density Do I Thin To?

Since commercial thinning determines the final density of the stand at harvest, so the stand should be thinned to the target density appropriate for that species. The Ministry of Forests has developed stocking guidelines to help you determine how many crop trees of different species you should have at the end of the rotation in order to fully utilise the growing site. The following tables indicate the target number of crop trees per hectare at the time of final harvest.

Stand Targets At Time of Harvest: Managed Stands				
<i>Species</i>	<i>Intertree Spacing (m)</i>	<i>Stems/ha</i>	<i>dbh (cm)</i>	<i>Height (m)</i>
<i>Coast</i>				
Douglas-fir	7 – 6.3	200–250	50–60	37.5 – 45
western hemlock	6.3 – 5.6	250–315	40–50	37.5 – 45
western red cedar	7 – 6.3	200–250	50–60	30 – 37.5
<i>Interior</i>				
Douglas-fir	7 – 6.3	200–250	40–45	27 – 33
western hemlock	6.3–5.6	250–315	35–40	30 – 37.5
western red cedar	7 – 6.3	200–250	45–50	34 – 30
<i>Province</i>				
Sitka spruce	7 – 6.3	200–250	50–60	37.5 – 45
white/Engelmann spruce	6.3 – 5.6	250–315	40–45	30 – 37.5
balsam (grand/amabilis fir)	6.3 – 5.6.	250–315	45–50	30 – 37.5
(subalpine fir)	5.6 – 5	315–375	35–40	34 – 30
larch	5.6 – 5	315–375	40–45	30 – 37.5
whitepine	5.6 – 5	315–375	40–45	30 – 37.5
lodgepole pine	4.8 – 4.5	440–500	30–35	34 – 30
yellow (ponderosa) pine	9 – 7.3	125–190	45–50	34 – 30

Note: The first set of guidelines are for *managed stands* that may have had earlier stand treatments (e.g., planting, brushing, juvenile spacing). The trees in these stands will generally be larger, more uniform in size and with larger crowns, than trees in unmanaged stands. This means that they will be better able to respond to thinning, and grow more quickly to fill the site. For previously *unmanaged stands* with smaller trees and a slower response time, 10 to 20% more trees may be left onsite after commercial thinning to grow until harvest.

The route by which you reach these final harvest targets and the number of thinnings you conduct, will depend on your management objectives, the species you are working with, and the limitations of your site.

Stand Targets at Time of Harvest: Unmanaged Stands		
<i>Species</i>	<i>Intertree Spacing (m)</i>	<i>Stems/ha</i>
Douglas-fir	6.5 – 6	230 – 290
western hemlock	6 – 5.3	290 – 360
western red cedar	6.5 – 6	230 – 290
Sitka spruce	6.5 – 6	230 – 290
white/Engelmann spruce	6 – 5.3	290 – 360
balsam (grand/amabilis fir)	6 – 5.3	290 – 360
(subalpine fir)	5.3 – 5	360 – 415
larch	5.3 – 5	360 – 415
white pine	5.3 – 5	360 – 415
lodgepole pine	4.5 – 4	510 – 630
yellow (ponderosa) pine	8.3 – 6.7	145 – 220

Other Factors to Consider

Local conditions such as snow loads, and the frequency and severity of seasonal storms, will influence the degree to which you thin your stands. In dense stands with shallow-rooted species it is often necessary to do two or three lighter thinnings that allow the trees to slowly develop some windfirmness. In areas of heavy snowfall, individual trees need time to develop thicker trunks that will enable them to withstand bending under heavy snow loads.

In coastal stands, where sunlight is the limiting factor, the timing and degree of 'release' are also important, so as not to expose the crop trees to too much sun, too quickly. Foliage that has developed in lower light levels is not adapted to conditions of direct sunlight, and like a fair skin it is susceptible to 'burning.' Early thinning is therefore recommended, before the trees develop a high proportion of 'shade needles.'

When thinning has taken place too late, you can often detect a delay in top leader growth as the tree recovers from this exposure. The degree of thinning shock and the resulting delay in growth varies with the amount of exposure and, of course, the species. Species which retain their foliage for many years (such as the true firs) are the hardest hit since they must re-grow a new set of sun-adapted foliage before the tree can return to its previous rate of height and diameter growth. Species such as pine, which replace their foliage every few years, suffer the shock of exposure less. Because of this setback, it is possible for the tree you have chosen for a final crop tree, and have spent money on to release and prune, may actually fall behind in growth and be overtopped by untreated co-dominants or shade tolerant suppressed stems. Be careful!

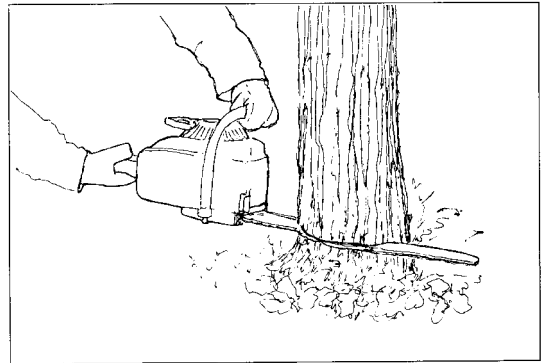

Where a stand has pockets of disease, thinning will focus on removing the susceptible species. In stands infected with root rot, you need to determine the location and type of the disease first, since your thinning method around those root rot centres will vary according to the disease type. In stands with a stem or needle disease, you are advised to consult with local pest management foresters regarding the appropriate thinning regime. The treatment will vary depending on the particular problem and crop tree species. In some cases extra stems are left on-site as insurance against those that may die; in other cases, where it is possible that site disturbance may spread an infection, diseased stands may not be thinned at all.

Thinning Logistics

One of the real benefits of small-scale woodland management lies in the ability to intensively monitor and manage stands. It is possible, through multiple thinnings over the life of the stand, to maximize the growth potential of your crop trees while reaping continued benefits from trees removed as thinnings. Stands can be kept fully stocked as they grow, with stems being removed only when they begin to interfere with the growth of the crop trees.

To do this, however, you must have good road access and be able to make repeated entries into your stands without damaging crop trees or the soils on your woodland. Further, the stems removed in each thinning must be of sufficient volume to pay for the costs of removal. These requirements will depend on whether you are able to do the thinning yourself, and the presence of markets for small wood products in your area. If no markets exist, it may be necessary to space your stand down to final harvest density in one operation. Keep in mind, however, that wider spacing may invite wind or snow damage and the growth of large limbs on the crop trees.

In most cases, thinnings can be timed to meet good log markets or your specific timetable. Heavy thinnings can be taken at infrequent intervals or light thinnings can be conducted more frequently in cases where markets for small wood products exist and extraction costs are low. Regardless of how thinning is done, the overriding objective is to maintain good crown cover, avoid high-grading, and achieve a good spacing for the development of the larger crop trees.

Thinning Equipment

As discussed in the chapter “Harvesting The Trees,” a variety of special equipment has been developed for small-scale harvesting and thinning operations. The lightness and maneuverability of this equipment enables multiple entries into a stand over its rotation, with minimal damage to the soil and the crop trees.

Small skylines (e.g., Mini-Alp) with light cable and short towers have been developed especially for the removal of small wood from stands on steep slopes. Small crawler tractors (e.g., DS, John Deere 450) and rubber-tired skidders (e.g., John Deere 440), are being used successfully for small-scale operations on moderate slopes.

In addition, equipment dealers are beginning to provide modifications for farm tractors that will allow the skidding of small wood. The Forest Engineering Research Institute of Canada (FERIC) has produced a number of reports on specialized equipment for small-scale woodland thinning and harvesting. A list of these is included at the end of the chapter. Tractor-mounted winches and small yarding machines such as the Swedish ‘Iron Horse’ or American ‘Radio Horse,’ make it possible for operators to harvest thinnings on their own, without the assistance of large machinery or even four wheels.

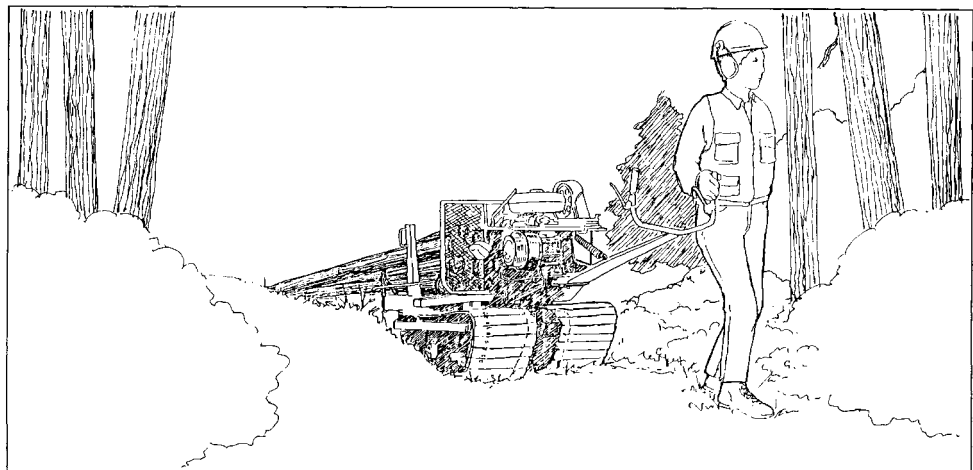

Horse logging is also proving to be a viable and inexpensive method of thinning small areas, and is being used in many environments. It is best suited to stands of gentle slopes, few obstacles, and good access since it may require more landings and trails than other skidding methods. The Cariboo Horse Loggers Association and your local woodlot association is your best reference for information on horse logging and horse logging contractors in the province.

Recommended References

Small Woodlands Program of BC

A comprehensive 'Small Woodlands Library' is available on the web [www.swp.bc.ca]

Canadian Forest Service

Pacific Forestry Centre

506 West Burnside Road

Victoria, BC, V8Z 1M5, tel.: 250-363-0600, fax: 250-363-0775

[www.pfc.cfs.nrcan.gc.ca]

Publications on many forestry-related topics are available on request from the on-line bookstore at [<http://bookstore.cfs.nrcan.gc.ca>]

Timberline Forest Inventory Consultants, 1997. *Forest Level Benefits to Commercial Thinning and Fertilization*, Ministry of Forests, Victoria, BC

Whitehead R. J. and B. N. Brown, 1997. *Modifying Silvicultural Systems for Lodgepole Pine - Windthrow After Commercial Thinning in Mature Lodgepole Pine*

Mitchell, J., 1998. *Forest Engineering Research Institute of Canada, Western Division Compendium of Commercial Thinning Operations*, FERIC
[www.feric.ca/en/index.html]

Ministry of Forests

Guidelines for Developing Stand Density Management Regimes, 1999, Victoria, BC

Introduction to Partial Cutting to Northern Interior Loggers, 1997, Workshop Handbook
[www.for.bc.ca/hfp/pubs.htm]

Farnden C., 1996. *Stand Density Diagrams*, Ministry of Forests, Victoria

Workers' Compensation Board

Partial-Cutting Safety Handbook, 1997

[www.worksafebc.ca]

Cariboo Horse Loggers Association

Box 4002, Quesnel, BC, V2J 3J2, tel./fax: 250-297-6305

mail to:chla@bcinternet.net,

[www.horselogging.org]

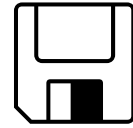

Agroforestry Overview

Multiple Use

In this chapter...

What is Agroforestry?	95
How Agroforestry Systems Work	96
What are Shade Systems?	96
What are Sun Systems?	97
What are Silvopasture Systems?	97
What is Integrated Riparian Management?	98
What are Timberbelts?	98
Defining an Agroforest	100
Benefits of Agroforestry	101
Recommended References	103

.....

What is Agroforestry?

This chapter is intended to give you new inspirations and ideas of what else you can do on your woodland. In 2001, the Small Woodland Program of BC published an excellent publication *A Guide to Agroforestry in BC*. This publication will give you an in depth source of information on agroforestry.

Agroforestry is a land management approach that deliberately combines the production of trees with other crops and/or livestock. By blending agriculture and forestry with conservation practices, agroforestry strives to optimize economic, environmental and social benefits.

Intensive management of trees, non-timber forest crops, agricultural crops and animals on traditional forest and agricultural lands is the key to successful agroforestry.

Agroforestry has been carried out in British Columbia for some time, although it has not been called agroforestry. The most widely recognized practice is the grazing of cattle and sheep in central interior forests, both to feed the animals and to control weeds that compete with the trees. Another well-established agroforestry system combines grazing with sustainable Christmas tree production in the east Kootenay.

How Agroforestry Systems Work

Agroforestry systems vary according to the resources available and the outcomes desired. Different management practices will yield different combinations of crops, products or functions (e.g., wind protection or soil stabilization). In BC, the five main management systems are:

1. shade systems: shade agroforests and forest farming
2. sun systems: sun agroforests and intercropping
3. silvopasture
4. integrated riparian management
5. timberbelts.

Note: Some plantations in BC—hazelnuts, Christmas trees, hybrid poplars—are grown as monocultures and are not true agroforestry systems. However, agroforestry management practices can easily be applied to these crops.

What are Shade Systems?

Shade systems are created when shade-requiring or shade-tolerant crops are intentionally managed under a closed tree canopy. *Shade agroforests* and *forest farming* are the two shade systems best suited to agroforestry in BC. They are usually established in an existing woodland. The two systems are very similar, though shade agroforests tend to be *extensive*, while forest farming is more *intensive*.

Numerous marketable plants can be produced in shade. They include:

- medicinal plants, such as ginseng and golden seal
- food products, such as fiddleheads
- species for landscaping, such as ferns
- floral greens, such as salal and beargrass
- craft products, such as cones, twigs and moss.

What are Sun Systems?

A sun system is managed for crops that grow between trees and require full sun to mature and become marketable. *Sun agroforests* and *intercropping* are both sun systems. They differ in that sun agroforests are established in existing forest, with trees in random patterns, while trees in intercropping systems are planted in rows for easier management.

Crops that can be produced in full sun include:

- horticultural plants, such as tomatoes and corn
- forages, grains and oilseeds
- tree crops such as plums and nuts
- Christmas trees
- shrubs, such as berries
- trees for lumber and woodfibre products.

What are Silvopasture Systems?

Silvopasture systems combine trees with forage and livestock production. Trees and livestock benefit each other in well-designed silvopasture systems. Owners of woodland and pastureland have found that this land-use approach provides excellent opportunities for generating additional income.

Crops and products that silvopasture systems yield include:

- meat and dairy goods
- forage and hay
- soft and hardwood lumber products
- nuts, tree fruit and berry crops.

To manage a silvopasture system, the landowner requires a knowledge of tree, cattle and forage interactions. Trees are managed to maintain adequate forage, while forage feeds livestock and benefits tree growth. Seeding is timed to give forage an advantage over native plants, and grazing is timed to minimize damage to seedlings.

The two primary silvopasture strategies are:

- Forest grazing – ‘livestock in the forest’
- Intensive tree pastures – ‘trees in the pasture.’

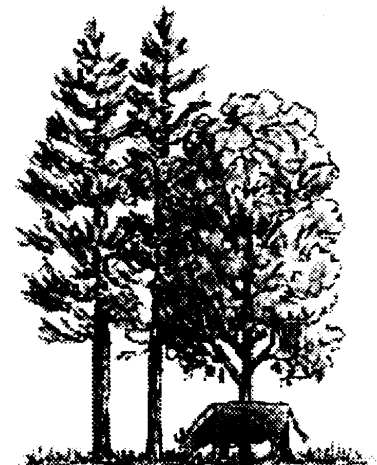

What is Integrated Riparian Management?

Riparian zones are complex systems composed of plants that are adapted to the moist environment bordering waterbodies and watercourses. This link between land and aquatic ecosystems performs vital ecological functions and is part of the network of watersheds that connect forest, agricultural and urban lands.

Integrated riparian management is the management of riparian zones to enhance and protect aquatic resources, while also generating economic benefits.

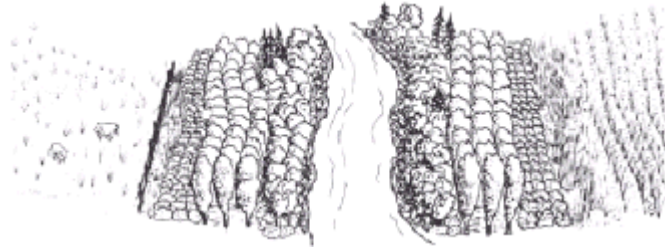

What are Timberbelts?

Timberbelts consist of multiple rows of trees planted for both production of tree crops and environmental benefits (e.g., wind protection, soil conservation, wildlife habitat). Economically, planting a variety of tree species provides a range in crops and rotations, including shade-tolerant plants that can be grown under the trees. Environmentally, timberbelts protect soil, water resources, crops, livestock and buildings from wind, drifting snow, dust, and in some cases, odours. Planting stock can be either native or introduced to the area.

Other timberbelts, or greenbelts, are established for wildlife habitat as part of riparian management, or to create a buffer between urban areas and agricultural or forestry activities. Trees or shrubs grown along fencelines may also be considered timberbelts, although fenceline plantings generally consist of fewer rows (usually only one).

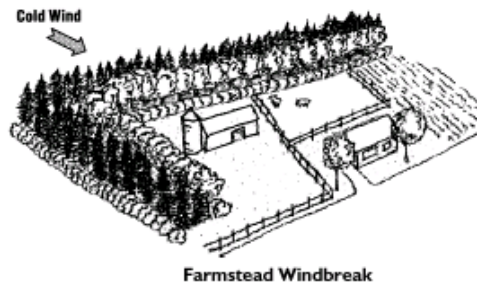
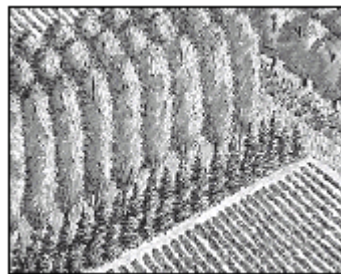

Crops produced in timberbelts include:

- timber, fenceposts, firewood
- Christmas trees
- boughs, cones
- nuts, fruits, berries
- transplants for landscaping
- shade-tolerant plants.

Shade Systems

Shade systems involve the intentional manipulation of trees, shrubs and ground vegetation to produce both timber and shade-requiring non-timber crops.

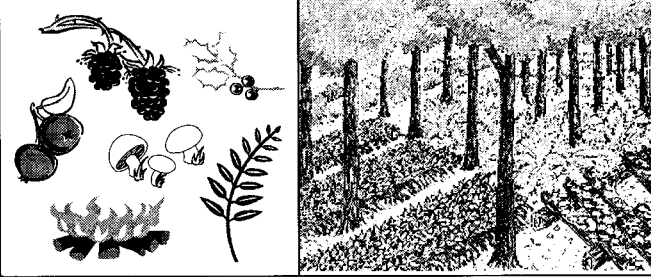

Integrated Riparian Management

Integrated riparian management is the management of areas bordering waterbodies and watercourses to enhance and protect aquatic resources while generating economic benefits.

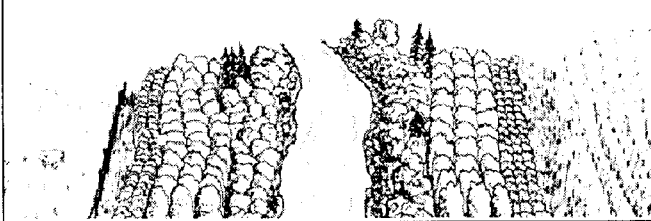

Sun Systems

Sun systems involve the planting of woody perennials with annual or other crops that require full sun.



Silvopasture

Silvopasture systems combine trees with forage and livestock production.

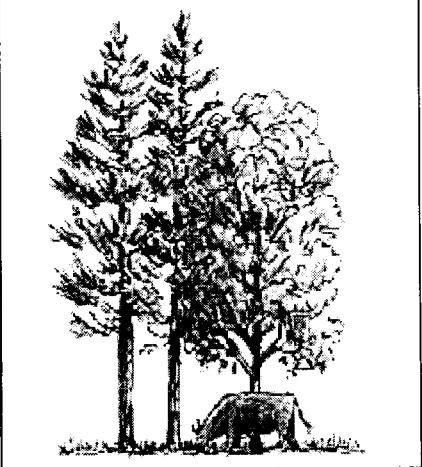

Timberbelts

Timberbelts consist of multiple rows of trees planted for both environmental protection and production of crops.

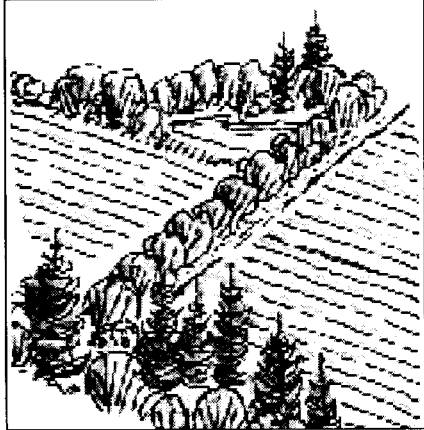

Defining an Agroforest

When a natural forest is managed to produce more or higher-quality crops, it becomes an agroforest. Activities that define an agroforest include:

- removing competing plants (sell marketable materials)
- adding mulches to control weeds and retain moisture
- adding nutrients
- adding irrigation
- spacing, pruning and thinning trees and understory plants (sell salvage if possible)
- multiplying existing plants
- introducing plants and trees from other sources
- managing livestock.

In addition to timber and other wood products, agroforests can yield non-timber forest products (NTFPs).

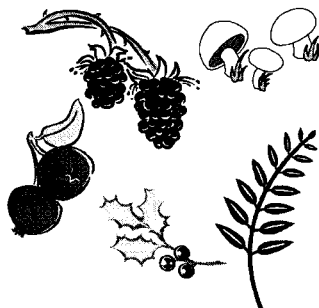

Agroforestry is much more than harvesting of non-timber forest products, although the same crops may be involved.

NTFP category	Examples
wild edible mushrooms	pine mushrooms, chanterelles, morels
florals and greenery	salal, red osier dogwood, cedar boughs, moss
medicinals and pharmaceuticals	devil's club, yew bark
wild berries and fruit	huckleberries, blueberries
herbs and vegetables	fiddleheads, cattail
landscaping/reclamation products	transplants, seed
craft products	conifer cones, bark, twigs, moss
miscellaneous NTFPs	smoke woods, cedarleaf oil

BC Non-timber Forest Products (after de Geus, 1995).

Key Features of Agroforestry Systems

Choice—not chance

Agroforestry systems are designed, created and managed to yield a variety of marketable crops and environmental benefits. You determine your goals for the system and intentionally combine the necessary components to work towards those goals.

It is important to note that the different agroforestry systems are not as distinct as they may seem. In fact, they are all closely related and interactive, and a combination of plants that is initially combined in one system, can develop over time into another system as the trees and other plants mature.

Multiple goals

Agroforestry systems meet a variety of needs. They can be designed to:

- generate short-term cash flow
- reduce costs of establishing a timber crop
- improve micro-climates (e.g., reduce wind speeds)
- restore riparian zones for environmental and economic benefits
- conserve resources
- bring unused land into production
- increase forage for existing animals or new livestock.

Constant change

Agroforestry systems are more diverse than forestry and agriculture monocultures and more dynamic than traditional agricultural practices. By their very nature, agroforestry systems will change over time; trees will grow taller, they'll cast more shade, and canopies will close in. Agroforesters need to look and plan ahead— further ahead than is usually the case for many farmers.

Benefits of Agroforestry

At a time when society is re-examining agricultural, forestry and other land-use practices, agroforestry is generating increasing interest as part of a comprehensive solution. In particular, the search for more sustainable agricultural systems in North America and elsewhere has been a driving force behind agroforestry. A number of important benefits can be derived from agroforestry systems:

More Profit

Well-designed agroforestry systems can increase revenue and decrease costs. For example, crop combinations that are well-adapted and compatible can generate more revenue per area planted than single species crops.

Short-Term Income

Non-woody crops can provide short-term income while high-value timber is grown simultaneously in the same system.

Tax Advantages

Growing farm crops may allow a reclassification to farm land, with a resulting property tax reduction.

Less Risk

Agroforesters can substantially reduce their risks by diversifying because growing a variety of crops spreads the risk. In addition, the variety in number and function of crops provides ecological stability making it less likely that pest or disease infestation will damage the entire system.

In contrast to more traditional thinking, mixing trees and other crops can actually enhance production if the system is properly designed. It's important to remember that planning and managing a diverse agroforestry system requires a long-term outlook and careful planning.

Enhanced Environment

Agroforestry provides a number of ecological and production benefits. First, soil quality and productivity can be enhanced through reduced erosion, recycling of nutrients through leaf litter decomposition, and the planting of crops that fix nitrogen needed by other crops.

Second, agroforestry systems can modify micro-climates by using trees to protect crops and animals from weather extremes. Third, agroforestry systems can improve water quality by reducing nutrient flows into waterways, providing shade to lower water temperatures and by providing sources of food and habitat for fish.

Better Use of Land

Arable land is fairly limited in BC, yet the land that is available is often under-utilized. Agroforestry can make better use of under-utilized land, especially by improving productivity on land considered marginal for agricultural production. In addition, agroforestry can produce agricultural and other non-wood crops from woodland without impeding timber growth.

Multi-storey agroforestry systems produce more crops from a piece of land and capture more of the available light and nutrients than mono-crop systems. Steven Sharrow, a range management professor at Oregon State University, found that *one acre of grass-legume/Douglas-fir silvopasture produces as much forage and timber as 1.6 acres of similar forest and pasture alone.*

With good planning, agroforestry can achieve better results without the ecological costs that may arise from single-crop agriculture or forestry.

Improved Communities

When agroforestry meets the economic objectives of individual landowners, spinoff benefits to society will follow. Successful land-use strategies create sustainable production systems, maintain biological diversity, protect water resources and increase fiber production from private lands.

Recommended References

Small Woodlands Program of BC

A comprehensive 'Small Woodlands Library' is available on the web [www.swp.bc.ca]

Small Woodlands Program of BC, 2001, *A Guide to Agroforestry in BC*, [www.swp.bc.ca]

Small Woodlands Extension Catalogue

available through SWP web page [www.swp.bc.ca]

Canadian Forest Service

Pacific Forestry Centre

506 West Burnside Road

Victoria, BC, V8Z 1M5, tel.: 250-363-0600, fax: 250-363-0775

[www.pfc.cfs.nrcan.gc.ca]

Publications on many forestry-related topics are available on request from the on-line bookstore at [<http://bookstore.cfs.nrcan.gc.ca>]

Ministry of Agriculture, Food and Fisheries, Agroforestry BC - Newsletter

contact carman.conn@gems3.gov.bc.ca, tel.: 604-556-3001

Oregon State University Woodland Workbook.

A compilation of articles, it can be ordered through

Publication Orders, Extension and Station Communications,

Oregon State University, 422 Kerr Administration, Corvallis, OR 97331-2119,

fax.: 541-737-0817.

[www.wood.orst.edu]

DeGeus, Nelly. 1995. *Botanical Forest Products*. Integrated Resources Policy Branch, BC Ministry of Forests.

[www.for.gov.bc.ca/hfp/botan/bot-toc.htm]

KWC Training. 1998. *Goods from the Woods: Developing Your Non-Timber Forest Products Business*

Schlosser, W., C.T. Roche, K. Blatner and D. Baumgartner, 1992. *A Guide to Floral Greens: Special Forest Products*. Cooperative Extension, Washington State University, EB1659 (\$US2.50), can be ordered at the following web site

[www.cahedb.wsu.edu/infopub]

von Hagen, B., J.F. Weigand, R. McLain, R. Fight and H.H. Christensen, 1996. *Conservation and Development of Non-timber Forest Products in the Pacific Northwest: An annotated bibliography*. USDA Forest Service Gen. Tech. Rep. PNW-GTR-375 t

[www.fs.fed.us/pnw/fight.pdf]

University of Missouri Center of Agroforestry, *Agroforestry, Training Manual for Applied Land Use Practices*, UMCA 2-2000

203 Anhaeuser-Busch Natural Resources Bld Columbia, MO 65211, tel.: 573-884-2874

umca@missouri.edu,

[www.missouri.edu/~umca]

USDA National Agroforestry Centre (NAC)

East Campus - UNL Lincoln, NE 68583-0822, tel.: 402-437-5178
[www.unl.edu/nac]

- Agriculture Canada, Ontario Federation of Agriculture, Ontario Ministry of Agriculture and Food, Ontario Ministry of Natural Resources**, 1993. *Best Management Practices: Farm Forestry and Habitat Management*. Guelph, ON.
- Ashton, Mark S.; Montagnini, Florencia**, 1999. *The Silvicultural Basis for Agroforestry Systems*. CRC Press, Boca Raton, FL.
- Buck, Louise E., James P. Lassoie and Erick C.M. Fernandes**, 1998. *Agroforestry in Sustainable Agricultural Systems*. Lewis Publishers, Boca Raton, FL.
- Clason, T.** 1998. *Agroforestry Practices for Small Farm Management*. Louisiana State University, Homer, LA.
- Columbia-Pacific Resource Conservation and Development Council**, 1998. *Agroforestry Resource Guide*. Aberdeen, WA.
- Garrett, H.E., W.J. Rietveld and R.F. Fisher**, 2000. *North American Agroforestry: An Integrated Science and Practice*. American Society of Agronomy, Inc., Madison, WI.
- Gordon, Andrew M. and Steven M. Newman**, 1997. *Temperate Agroforestry Systems*. Biodiversity International, Buckingham, UK.
- Hodge, Sandra S., William Walter, and Sara M. Peters**, 2000. *Agroforestry: Training Manual for Applied Land Use Practices*. University of Missouri Center for Agroforestry, Columbia, MO.
- Rayment, Barbara**. 2000. *From the Ground Up: A Horticultural Guide for North-Central BC*. David Douglas Botanical Garden Society, Prince George, BC.
- Seyler, James and Micheal Gold**. 1993. *A Checklist of Suggested Guidelines for the Design and Evaluation of Small Scale Agroforestry Projects*. Department of Forestry, Michigan State University, East Lansing, MI.
- United States Department of Agriculture**, 1999. *Agroforestry for Farms and Ranches*. Ecological Services Division, U.S. Department of Agriculture, Washington, DC. Also available on line at <http://www.nhq.nrcs.usda.gov/BCS/forest/tnote1.html>
- Wojtkowski, Paul**, 1998. *The Theory and Practice of Agroforestry Design*. Science Publishers, Inc., Enfield, NH.

Woodland Roads

Forest Access

In this chapter...

What Are My Access Needs?	105
How Do I Plan a Road Network?	107
Road Construction – How Much Can I Do?	108
Equipment	109
Construction Steps	110
How Do I Care For My Roads?	113
What Are The Environmental Considerations?	114
Sample Road Construction Contract	116
Recommended References	120

.....

What Are My Access Needs?

A woodland road system serves many transportation purposes, including the extraction of timber, access for silviculture treatments, fire control and recreation. Your objective in developing a road network will be to provide for these uses with the minimum disturbance to the land base and your pocketbook.

This chapter discusses the major considerations in developing your access network, including road layout, construction, maintenance and environmental considerations. Skid or forwarding trail development is dealt with in the chapter “Harvesting the Trees.”

Access is vital to a well-managed woodland. You will need to consider a number of different forms of access to your property; general access via main roads and trails, new logging roads for the removal of timber, branch roads to take you and your equipment to stands requiring spacing, thinning, and pruning, and protection roads to water sources. The building standard will vary with each type of access, depending on the type of vehicle and volume of traffic it will carry, as well as the season of use.

The best approach to road building, environmentally and financially, is to build to the minimum standard required for the projected use. Good planning, engineering and construction are the keys to keeping costs to acceptable levels.

Your road needs will depend on a number of things, including your management objectives, the location and characteristics of your timber, terrain conditions (such as rock, swamp, slope), and the silvicultural system and logging

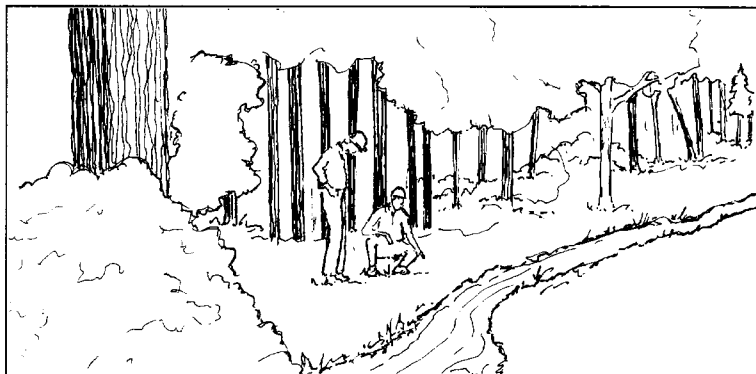

methods you plan to use. Part of your initial considerations should include the assessment of existing access roads and trails. One of the benefits of working in second growth stands is the presence of old roadbeds, railway grades and skid trails from when the stand was first cleared. In these areas only minor road upgrading, such as widening or spur road development may be required to complete an access network, and you can often acquire enough knowledge to do it yourself. Where major road location and construction are required to develop a woodland area, an experienced contractor or consultant should be called in to ensure that the most efficient and safe road system is developed.

How Do I Plan a Road Network?

Your first task in planning your road network will be to sketch out main routes that provide the best coverage of your woodland and access to particular sites of importance. The purpose of this initial plan is to locate the road network to cover the whole area, while minimizing the total length of road required. Begin the process of road location at the drawing board, with aerial photos and a good contour map of the area. Pencil out possible road routes based on the following considerations:

1. Follow contour lines where possible. Try to keep road grades below 10% (no more than 1 metre of vertical rise for every 10 metres horizontal distance).
2. Avoid depressions which may catch and hold water.
3. Steer clear of trouble spots such as swamps, rock outcrops, etc.
4. Minimize the number of stream crossings.
5. Keep a distance from stream and leave a 'green belt' of undisturbed soil and vegetation between roads and waterways to filter runoff and minimize erosion. On flat land, the green belt should be at least 10 metres wide, more on slopes. (Width will vary with topography, stream width, bank stability, fish-bearing quality, etc.).
6. Identify potential sites for landings (flat areas for loading logs onto trucks), such as saddles, benches or ridges.
7. Make use of old road grades or common road systems wherever possible.
8. Road curves should be located on minimum grades. Try to avoid sharp curves, but if unavoidable, provide extra road width in these curves.
9. Avoid unstable soil conditions that could create erosion problems and deposit sediment in fish bearing streams. Indicators of potential slope instability are jack-strawed trees (trees tilted in various directions), split trees, pistol butt (recurved) trees, soil and rock piled up on upslope side of trees, deep, fine textured soils, shallow, wet organic soils, recent scours, sluffs and slides.
10. Watch for potential sources of gravel or fractured rock to be used for road balasting and culvert beds. Rock cuts can also provide material for armouring culverts, dispersing runoff and preventing erosion. Rock can also be used to bring a road up to grade level, reducing the amount of gravel needed for the running surface.
11. Note requirements for culverts and bridges.

Ideally, the road system should be planned for long-term use and to be suitable to access stands that are currently immature but will be harvestable at some point in the future. Depending on the terrain and control points (e.g., stream crossings, rock bluffs) main access roads should have a spacing of 300–400 m and 100–200 m distance to the woodland boundary. Additional, short spur roads or forwarding trails will help to further access pockets and bands of harvestable timber. For ground-based harvesting systems, the access roads should be located at the lower end of the slope. For cable-based harvesting

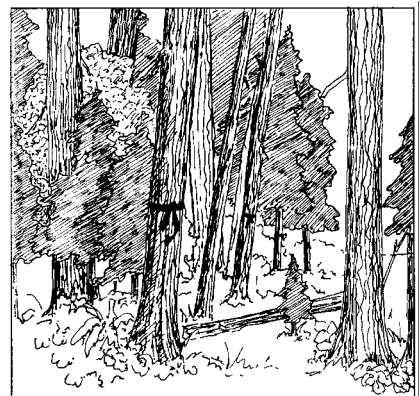

systems, it is best to have the road located at the slope ‘break’ at the top of the slope. However, if necessary, uphill yarding on moderate slopes is possible with some ground-based harvesting systems (i.e., hoe chucking, track skidders) and cable systems can usually cope with down hill situations. Since roads, once built, can not be moved easily, you should discuss your plans in your woodland with experienced road builders and logging contractors.

When the road system has been located on the map, the next step is to lay out the roads on the ground. The field location will be based on control points, or those must do items noted in the road planning phase, such as bridge crossings, important timber stands, landing locations and junctions. Forest roads can usually be surveyed using basic hand tools consisting of compass, clinometer, survey chain, calculator (conversion of slope distance) and flagging tape.

Steepness of the road, or gradient, is usually the main concern, and should be limited to about 15% (20% maximum) for long, favourable slopes and 8% for long, adverse slopes. The terms *favourable* and *adverse* relate to the conditions facing a loaded logging truck; a grade is favourable when the loaded truck is going downhill, and adverse when the loaded truck is going uphill. For short stretches, favourable grades can be increased to up to 25%, and adverse grades to 12%. Road grades over 7% are vulnerable to water erosion of the road surface. To avoid the requirement for constant maintenance and repair, coarse angular rock as ballast or surfacing material should be used. This type of material will also help logging vehicles to navigate steep road sections.

Road Construction – How Much Can I Do?

Road building usually follows a schedule based on which areas are slated for harvesting or special treatments first. The construction requirements will vary with the drainage, grade, slope, obstacles, stream beds and stream crossing conditions of the site. Before construction actually gets underway, you will have to decide whether to do-it-yourself or hire a contractor. In many cases, you will not have access to the equipment needed for road construction, and if the job is large or complicated you will likely want to hire a competent forest road contractor. However, in many instances, light duty roads can be constructed by competent landowners using a dozer or a small excavator and other earth moving equipment.

Contracting can be done either as a complete package for a finished roadway at a lump sum price, or for specific portions at hourly rates that include the manpower and equipment. You may choose to include road building as part of the harvesting contract for a particular area. Your choice may be influenced by the availability of contractors in your area as well as your ability to supervise the work. At a minimum, be prepared to be on-site at the start of any excavation, for construction of stream crossings, and for a final check before the contractor leaves.

A clear road construction contract should be drawn up which specifies the extent of the work, method of construction, method of payment, schedule of work, standards of work, holdback requirements and arbitration procedure if work is in dispute. Be sure your contractor has adequate liability insurance and current Workers Compensation Board insurance coverage. If a mishap occurs, you as the landowner may be held responsible. A sample road construction contract is found at the end of this chapter.

Skid trails can be considered an extension of the road network and should be laid out and constructed with appropriate care, depending on the projected level of use. Logging plans should balance skidding distance with road construction costs to ensure the most efficient logging pattern. Skid trail layout and construction are discussed further in the chapter “Harvesting the Trees.”

Equipment

Whether you are planning to do-it-yourself or hire a contractor, you will need to consider the appropriate equipment for the job. Bulldozers, excavators and front-end loaders are common choices; each has advantages for particular situations.

Most forest roads are built with excavators, which are multi purpose machines that can perform numerous different tasks in your woodland, including stump pulling and harvesting (hoe chucking). Excavators perform well, if the road construction does not require horizontal movement of excavated material, though this limitation can be overcome by using a truck for end-hauling. The hoe is well-suited to soft, wet conditions, or situations requiring the breaking of small amounts of isolated or loose rock.



Bulldozers have their application if road material needs to be moved horizontally over a short distance. The size of the bulldozer required for the job will vary with the total earthmoving requirement as well as the type of soil. These machines come with a variety of front-end blades and rear-mounting attachments like logging winches, rippers and stump-splitters, which make them versatile for many woodland activities.

Front-end loaders can be fitted with a bucket for loading gravel onto trucks or for transporting material for short distances. For minor road building in favourable conditions, a farm tractor with a bucket and a blade will suffice. Progress, however, may be very slow. The choice of equipment for road construction must balance efficiency with operating cost.

Construction Steps

Road construction begins with clearing of the right-of-way. All saleable wood from right-of-way clearing should be recovered, and tops, branches and stumps should either be buried beneath fill on the low side of the right-of-way, scattered into the forests, or piled and burned. Construction should be timed for efficient working conditions—avoiding trouble periods such as spring runoff and winter freeze. On poorly drained soils, road construction should be carried out during the dry season.

The use of *geotextiles* in forest road construction is increasing. These woven or spun fabrics are made from various organic and synthetic fibres. The purpose of placing geotextiles is to reduce the horizontal or vertical movement of road material. They are used on unstable road cuts or fill slopes to prevent erosion. Geotextiles are also laid down over rock ballast, puncheon or bridge decking to prevent fine silts from moving to the soil surface or into watercourses.

There may be instances where you do not want to disturb the root systems or disturb the flow of groundwater with ditches and removal of the overburden. When you place a road on soft, wet ground without removing the organic soil it is termed *overlanding*. It is possible to use puncheon or corduroy (non-merchantable wood) placed tightly together, and covered with ballast. In addition or alternatively, use a layer of geotextile as a separator to prevent the intermixing of mud that can work its way up to the running surface by the hydraulic pumping action of the traffic on the road.

Road width requirements will vary according to the frequency of use, the size of vehicles using the road, and the type of products moved. In general, a road with a finished surface of 4–6 metres is suitable for most forms of small-scale woodland transport. The right-of-

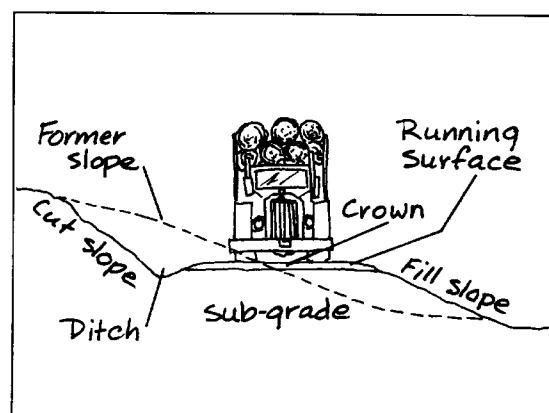

way should extend approximately 1 to 2 metres beyond the cut and fill to allow the safe travel of large vehicles. The roadway itself should be higher than the surrounding ground to ensure that it does not become a drainage ditch. Woodland roads of 5 metre widths should have an average ditch depth of at least 0.5 metre and ditch width of 1 metre. These dimensions may vary widely, depending upon the construction material. Extra ditch width is recommended in silt and clay conditions, while shallower ditches are acceptable in rock.

On sidehills, cut bank slopes should not be steeper than 1:1 (1 metre of horizontal distance per metre of vertical rise); and fill bank slopes not steeper than 1.5:1 (1.5 metres of horizontal distance per 1 metres of vertical rise). For steep side slopes with potential for slumping, consider cutting the road profile deeper into the slope and moving the surplus material to fill or spoil areas. Do not support your road on downslope stumps, trees or cull logs. Cut and fill banks can be seeded, planted or terraced for soil stability. If you believe there is a chance of slumping or sliding above or below your road, consider placing “willow wattle.” These are bundles of willow (*Salix* spp.) or cottonwood (*Populus* spp.) which are fixed across the slope with stakes of the same species. Both these species have the ability to root readily, so as soil and debris accumulates behind the

bundles, the stakes and the bundled material will grow into the hillside providing stability and erosion control.

The secret to a good roadbed is to keep it well-drained. Proper ditching is one of the keys to road stability, and the size and frequency of culverts is also very important. On flat land, ditches should be placed on both sides of the road. Roadways on slopes only require ditching on the topside, sloped to drain water away from the road. Avoid long grades—they are susceptible to water buildup and require extra culverts. A light crown in the centre of the road will assist drainage and minimize the formation of potholes. If you have a well drained, vegetated and stable upslope, you may consider not to construct a ditch, but rather grade a shallow outslope to the road so water drains off. Be sure there are no berms left after construction or grading that would not let water escape.

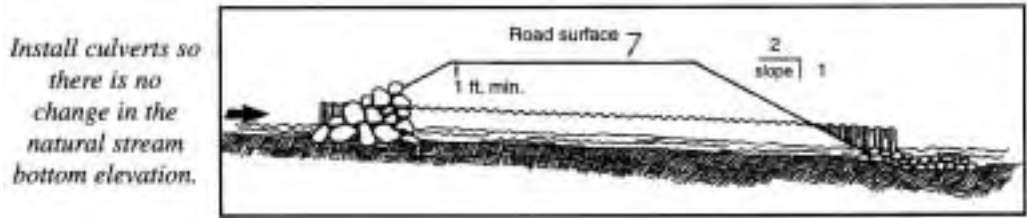

Culverts should be placed wherever water drains naturally. Their purpose is to drain excess water from roads and ditches and support natural drainage patterns. As a rule of thumb, plan on approximately 5 culverts per kilometre of roadway on average ground. Vary the number according to your specific site conditions.

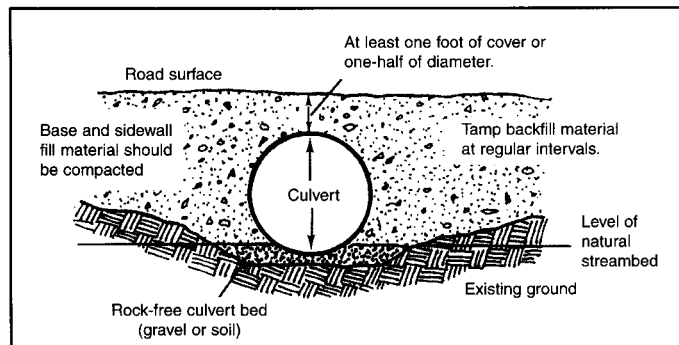

Installation of culverts.

(Adapted from Montana Department of State Lands, 1992.)

Culverts can be log culverts constructed on-site or circular metal culverts. In any case, they need to be large enough to handle peak water flows and it is better to err on the side of caution. Wooden culverts should be constructed from cedar to prolong their life.

Elevation view

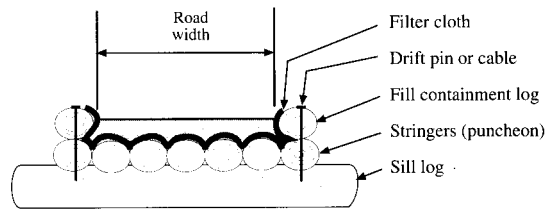
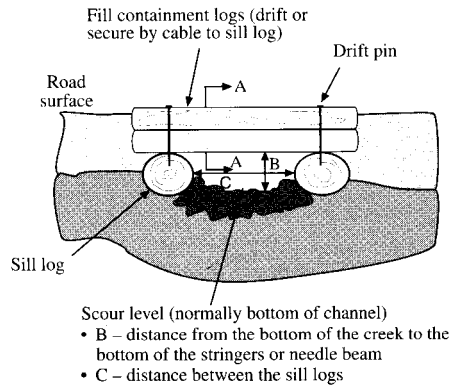

Cross-section A-A

Not to scale.

Notes:

- Opening size: must pass peak flow for 100-year return period plus minor debris; B min. 0.5 m; C min. 1.5 m.
- Road width: varies with road curvature.
- Culvert width (as measured parallel to stream): varies with road width, height and type of fill, culvert gradient and skew.
- Sill logs: place outside stream channel and below scour level; species can vary. Minimum diameter is 36 cm; long enough to support stringers, fill containment logs and road fill.
- Non-woven geotextile (filter cloth) minimum grab strength of 700 newtons (MD).
- Stringers (puncheon): match in diameter and taper, and be free of decay and excessive crook or sweep; spiral grain should be less than 1 in 8. Knot size in middle should not exceed 125 mm. See Table 12 for sizing.
- Fill containment logs: minimum diameter 400 mm. If lashing is used, inset the cable to protect it from damage by road maintenance equipment.
- Connections:
 - stringers to sill: 12 mm spiral drifts
 - fill containment log to sill: 18 mm spiral drifts or 4 wraps of 18 mm diameter 6 * 9 fibre core wire rope.
- For permanent roads, use sound western redcedar for all components.
- Inlet control: place rock to protect against fill erosion to the 100-year flood level.
- Outlet control: place rock as required to prevent outlet scouring and undermining of the sill logs.

Untreated Douglas-fir or spruce may be an alternative, though these will require replacement more frequently. Use a layer of geotextile over any wooden structure to minimize siltation. Though metal or plastic culverts are more expensive items, they may be a cost-effective alternative due to their ease of placement and durability.

Locating Culverts

- place at right angles to roadbed to minimize culvert length
- make sure culverts are firmly footed to settle evenly when covered
- where road grades are greater than 6%, culverts should be angled or skewed toward the grade
- provide adequate culvert slope (2–3%) so that water flows freely through the culvert and sediment does not build up at lower end
- culvert must be large enough to anticipate snowmelt and storm water flows
- culverts must be placed at a level to 'capture' and channel water flows, but not so low that they capture and accumulate debris; a settling pond needs to be placed adjacent to the intake to protect the culvert from being blocked by moved material
- culvert should be covered with fill to a depth equal to or greater than the culvert diameter (or as recommended by the manufacturer)
- a ditch plug should be installed below the culvert, on the intake side, to prevent water from flowing further down the ditch; construct the plug or block lower than the shoulder of the road so that any overflow will continue down the ditch and not down the road
- armour culvert intakes, outflows, and discharge areas to prevent scouring and erosion.

Particular care must be taken with installing culverts at stream crossings. Stream bed disturbance should be minimized and the use of broken rock, vegetative cover or other means to reduce soil movement into the stream are advised. Federal Fisheries officers and/or officers from the local Ministry of Water, Air and Land Protection should be consulted regarding specific procedures and timing of construction in fish-bearing streams. Most of the times you will be required to use open bottom culverts in order to not destroy existing fish habitat.

Bridges

Bridges are recommended when stream flows require steel culverts with diameters above 120 cm, or log deck culverts with a span of over 3 metres. At this point, call in the experts. The cost of professional advice is worth it.

Fords and Swales

Your road may cross a shallow low-flow stream or seasonally wet area (no down stream fish or water source values). An alternative to a culvert is a properly constructed ford or swale. Remove any silts and fine soils on the approaches or in the ford/swale. Stabilize the approaches with uphill waterbars. Lay down geotextiles to strengthen the roadbed. The bottom of the ford/swale must be firmly ballasted with coarse rock. Shot-rock works best as it does not pack solid, but leaves channels for water flow. The purpose of a ford is to provide a safe, erosion-free and storm proof crossing that requires little or no maintenance.

Ballasting

Forest roads require ballasting to provide for all-weather hauling. Ballasting, however, may be an expensive construction step, in case there is no suitable material in place. The costs of ballasting are high due to the amount of equipment involved—usually a hoe or loader, a truck to haul the gravel and another hoe or small bulldozer for spreading the material. These costs rise rapidly with the distance of the gravel source from the road. Where traffic is light and seasonal, packed dirt roadways, with only the trouble spots gravelled, may suffice.

For final shaping of the road profile, nothing matches the production and quality of a road grader. Inquire at your local Ministry of Transportation and Highways to see if they or their contractor may have a machine in your area. It is often possible to coordinate activities and obtain a very reasonable rate.

How Do I Care For My Roads?

A well-planned and constructed roadway will minimize potential problems, but a regular maintenance program is needed to ensure the long-term stability of a road system. In most cases you will be able to carry out an effective road maintenance program with hand tools, some gravel, and a truck. Potential trouble areas, such as wet spots, culverts and steep grades should be noted. Regular inspections should be carried out, with additional checks after heavy rains. New roads and roads with heavy traffic should get special attention. Springtime maintenance is most important—a little shovel work early in the season can prevent potentially larger problems later on.

Maintenance inspections should check all drainage structures, removing debris from ditches and culverts. Watch ditches for flooding or signs of bank erosion that may signal the need for more, or larger, culverts. Check inlets and outlets of culverts for scouring. Road grading should be carried out as needed to maintain road shape and surface, depending on the size of operations and frequency of use. Ruts and pot holes should be filled in before spring rains. Cut banks may be vegetated to combat erosion. There are several commercial seed mixes available for varying roadside conditions (e.g., sunny, shady, wet or dry). Spur roads not needed all the time, can be put to 'bed' by digging short drainage ditches (water bars) across them to control winter and spring runoffs.

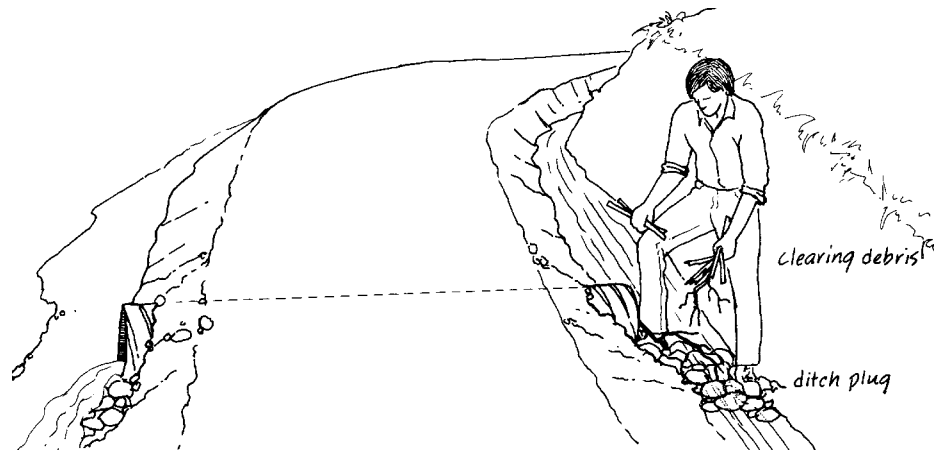

What Are The Environmental Considerations?

Road development has a major influence on the efficiency and cost of harvesting operations. It is important that roads are well planned, engineered and constructed from the outset. Road building requires a large commitment of financial resources and specialized expertise to minimize environmental impacts. Though logging is often believed to be the source of erosion and siltation, it is the roads associated with logging that are often the real cause of such damage.



The importance of careful planning and construction cannot be overemphasized. Poorly laid-out or inadequately constructed roads may cause many headaches later on. The dislocation of vegetation and soil, and manipulation of water flows brought about by road

building can have harmful effects on the environment. Waterways are the most vulnerable since they pick up the silt and debris that are disrupted during construction. The design and location of culverts is especially important to offset potential problems.

The Ministry of Water, Land and Air Protection and the Federal Department of Fisheries and Oceans share the responsibility of overseeing the use and care of watercourses in the province. Stiff penalties are enforced for violations to the Federal Fisheries Act that result in damage to fish-bearing streams, rivers and lakes. Guidelines and regulations are available from both governments and should be consulted for the road construction and logging phases.

Protection Guidelines

- construct roads reasonable distances from fisheries sensitive zones (these are small water bodies such as back channels on main rivers or streams, swamps or bogs that are important for spawning and rearing)
- avoid construction in areas of high slope instability
- stop construction when soils are extremely wet
- leave streams clear of construction debris
- provide adequate sub-grade drainage
- ensure that drainage is adequate to handle interrupted surface and sub-surface flows
- maintain width and gradient of active stream channels
- leave roads, drainage structures, and watercourses in a condition to minimize erosion.

In general, inexperienced people should only attempt road building under favourable conditions (i.e., well-drained soils, slopes below 30%, stable terrain, no major stream crossings) and in situations where the road will not be subject to intensive use. In all other circumstances, advice from experienced operators is recommended.

Steps to Road Building

- develop road plan for woodland area
- determine road specifications for each Management Area
- for major, long-term roads seek help
- lay out roads on maps and aerial photos, then locate roads on the ground
- clear right-of-way
- build the sub-grade (the basic road bed shape)
- install drainage structures
- ballast the road where necessary.

Sample Road Construction Contract

The following contract is a sample format for your consideration. Note that a contract should be adapted to the particular requirements of each situation. In addition to the items addressed in the following sample contract, you may wish to provide for: Additional Work, Directions to the Contractor, Representations, Curtailment, Special Provisions, Insurance, Assignment and Subcontracting, Default by Contractor, Insolvency of Contractor, and Termination. You are advised to seek legal counsel regarding your contract documents.

ROAD CONSTRUCTION CONTRACT

THIS AGREEMENT made the _____ day of _____, 20____

BETWEEN A.B. Cee
(Hereinafter called the “Owner”)

OF THE FIRST PART
AND XYZ Construction Ltd.
(Hereinafter called the “Contractor”)

OF THE SECOND PART

WHEREAS the Owner wishes to build an access road of specifications detailed below, within District Lot 000 as shown in red on the map in Exhibit “A” attached.

AND WHEREAS the Contractor has agreed to construct the said road in accordance with the terms and conditions set forth in this Agreement.

NOW, THEREFORE, THIS INDENTURE WITNESSETH that the parties hereto agree, each with the other, as follows:

1. LOCATION:

The Owner has identified the location of the proposed road on the ground by survey stakes flagged with pink ribbon. The Contractor has viewed the location and agrees that the proposed road is 0.75 km in length.

2. ROAD STANDARDS

The road shall be constructed to the standards specified as follows:

- a) Surface width: _____
- b) Right-of-way: _____
- c) Gravel depth: _____
- d) Culverts: The Contractor will provide all materials as required by the Owner and stated herein:
materials: _____
minimum size: _____
frequency: _____
- d) Ditch depth: _____
- e) Rock excavation: _____

3. EQUIPMENT

The road will be constructed with the following equipment: _____

4. GRAVEL

Gravel will be taken from borrow pit indicated on the Exhibit "A" map. The Contractor acknowledges having viewed said pit.

5. FIRE REGULATIONS

The Contractor agrees to comply with all Provincial Government regulations relating to the safety and security in respect to fire or other hazards, and that during the fire or dry season, April 1st–October 31st, unless otherwise specified by the Ministry of Forests, will take all precautions prescribed by *Forest Practice Code of British Columbia Act* or the regulations thereunder, or as may be specified by the Owner, and shall cease work if the Licencee deems it necessary.

The Contractor agrees to supply and keep on site the appropriate fire fighting equipment as required by the regulation for crew size, small and large engines and to follow the shift/shutdown schedule of the Ministry of Forests in _____ for this area.

The Contractor agrees to have a person in charge present on the work site for the duration of the road construction who has been trained to a level acceptable to the Ministry of Forests in areas of fire suppression techniques, fire behavior and fire line safety.

6. PRELOGGING

The Contractor shall, prior to commencing construction of said road, fell, limb and skid all trees within _____ metres on each side of the flagged centreline to the landing designated on the Exhibit "A" map. All logs or trees shall be limbed and topped prior to yarding or skidding. Utilization will be a maximum of 30 cm stump height, 10 cm top diameter inside bark and a minimum log length of 3 m.

The Contractor shall manufacture the trees into merchantable logs according to the bucking specifications and standards provided by the Owner. Merchantable logs are defined as logs containing at least 50% sound wood and of greater than a minimum top diameter (inside bark) or minimum slab thickness of 10 cm and a minimum log or slab length of 3 m.

"Rub" trees should be left standing along the working areas until road construction is complete and final yarding takes place. Those rub trees are to be utilized and yarded as well. The Contractor is required to suspend work in heavy rain and if the ground is saturated with water.

The Contractor shall use the timber mark as supplied by the Owner (_____) and hammer stamp at least 2 log ends at both the front and back corners of each truck load as well as paint the timber mark on the side of each load. The Contractor shall provide the logging truck operators with the appropriate load slips and retain a completed copy on behalf of the Owner.

7. SLASH DISPOSAL/WASTE

The Contractor agrees that all slash, logging debris or waste resulting from the Contractor's operations will be disposed of by the Contractor to the satisfaction of the Owner. Littering is prohibited in the area of operation.

Stumps are to be buried in depressions as much as possible with topsoil, but not within the road profile or fill slope. Remaining stumps are to be piled and burned, or scattered

into the standing timber. Excessive piles of overburden along the road side are to be avoided and need to be scattered or transported to low spots, if necessary.

8. OWNERSHIP

All logs produced from District Lot 000 belong to the Owner.

9. TIMING

Prelogging of the right-of-way shall commence on _____, 20____, and construction of the road shall be completed by _____, 20____. It is agreed that time is of the essence hereof.

10. PAYMENT

The Owner has agreed to pay the Contractor \$ _____ for prelogging and construction of the said road. Payments shall be scheduled as follows:

- a) Upon completion of prelogging \$ _____ (commonly 10–15%); less 10% hold back.
- b) Upon completion of grade construction, including gravelling and ditching \$ _____ (commonly 40–50%); less 10% hold back
- c) Upon completion of slash disposal, removal of log debris, and road construction in a good workmanlike manner \$ _____ (commonly 25–40%), less 10% hold back.
- d) Within 60 days of the completion of road construction the 10% hold back upon notification of WCB clearance less any amounts necessary to pay penalties and to repair damages to access roads, or third party property and to leave the area in a workman-like manner in keeping with good standards of road construction and logging practice.

11. FIRST AID AND EMERGENCY PLAN

The contractor shall, provide at all times of any operations under this contract a First Aid Attendant with adequate and up to date training required for the particular crew size and work hazard class. The contractor shall further provide as per WCB regulation all required means of communication, First Aid supplies, Safety Equipment and Emergency Transportation Vehicle. Prior to commencing the work under this contract, the contractor shall to the satisfaction of the owner and WCB officer prepare and carry an Emergency Response Plan with a list of emergency procedures, contact numbers, frequencies and back-up procedures. The contractor shall notify WCB within three days of commencing the work of the location of the work site.

12. APPLICABLE LAWS

The Contractor shall, while performing the work hereunder, observe and perform (and pay and satisfy all assessments or remittances pursuant to) the provisions of the *Workers' Compensation Act*, *Employment Standards Act*, *Unemployment Insurance Act* (Canada), and the Canadian Pension Plan (Canada), and regulations thereunder, and the hours of work laws and minimum wage laws of British Columbia and all other governmental regulations, statutes and orders (including obtaining all permits or authorizations) pertaining to or having a bearing upon the Contractor's work hereunder, and shall indemnify and save harmless the Owner in respect thereof.

The Contractor's WCB No. is _____

(The Owner has confirmed by phone that the Contractor is in good standing with WCB)

13. LIABILITY

The Contractor shall indemnify and hold harmless the Owner and/or any third parties from any and all loss, costs, damages, expenses and claims of every nature whatsoever arising from any fire caused by the negligence of the Contractor or any breach of or failure to observe any provincial, federal and municipal government laws, regulations or instructions.

The Contractor shall carry \$2,000,000 Comprehensive General Liability insurance including a minimum \$500,000 for Forest Fire Fighting Expenses.

The Contractor's policy No. is _____ with the following Insurance Company: _____ in _____

(A copy of the policy has been retained by the Owner)

14. TERMINATION

This contract will be terminated upon any of the following conditions:

- a) Unsafe work practices as identified by WCB or the Licencee including use of alcohol or drugs on the worksite.
- b) Failure to respond to directions given by the Licencee to the Contractor or their employees or Sub-Contractors.
- c) Failure to comply with any of the provisions of Sec. 11, Applicable Laws.
- d) Failure to commence work under this contract within 2 weeks of date in Sec. 8, Timing.
- e) Failure to comply with any standard of this contract.
- f) Failure to avoid, in the opinion of the Owner, environmental damage.

15. ARBITRATION

In the event that any dispute arises between the parties hereto which cannot be reasonably settled, the dispute shall be settled by a single arbitrator appointed pursuant to the *Commercial Arbitration Act*. Both Owner and Contractor shall be bound by the arbitrator's ruling, and shall pay equal portions of any expenses incurred.

16. NOTICE

For the purposes of this Agreement, notice shall be deemed to be given to the Owner at (Owner's address), and to the Contractor at (Contractor's Address), or to such other places as shall be from time to time substituted in writing, and such notice shall be deemed to have been received when delivered by hand or forty-eight hours from posting by registered mail from any post office within the Province of British Columbia.

IN WITNESS THEREOF the parties hereto have executed this Agreement.

Date: _____

Owner: _____

Contractor: _____

Recommended References

Small Woodlands Program of BC

A comprehensive 'Small Woodlands Library' is available on the web [www.swp.bc.ca]

Canadian Forest Service

Pacific Forestry Centre

506 West Burnside Road

Victoria, BC, V8Z 1M5, tel.: 250-363-0600, fax: 250-363-0775

[www.pfc.cfs.nrcan.gc.ca]

Publications on many forestry-related topics are available on request from the on-line bookstore at [<http://bookstore.cfs.nrcan.gc.ca>]

BC Ministry of Forests

Forest Road Engineering Guidebook, 1995, FPC of BC, BC Environment

Ground Skidding Guidelines, Engineering and Silviculture Branches

Protecting Forest Soil, Silviculture Branch

Road Construction, Maintenance, and Deactivation, 1993, Vancouver Forest Region

Coastal Fisheries Forestry Guidelines, MoF, MoELP, DFO, COFI

Nova Scotia Department of Lands and Forests

Building Standard Woodland Roads, 75/109/10

Forest Access Roads - Construction Guidelines, 76/12/12

Oregon State University Extension Service

Planning Woodland Roads, Extension Circular 1118

Road Construction on Woodland Properties, Extension Circular 1135

Designing Woodland Roads, Extension Circular 1137

Maintaining Woodland Roads, Extension Circular 1139

Designated Skid Trails Minimize Soil Compaction, Extension Circular 1110

[www.orst.edu]

University of Minnesota Extension Service, *Forest Management Practices Fact Sheets*,

Univ. of Minn. Distribution Office, tel.: 612-625-8173 or

[www.cnr.umn.edu/FR/extension]

Managing Water Series

#1 *Project Planning: Locating Roads, Landing, Skid Trails and Crossings*

#2 *Managing Water on Roads, Skid Trails and Landings*

#3 *Earth Berm Water Bars*

#4 *Using Logging Debris or Logs to Build Water Bars*

#5 *Conveyor Belt Water Bars*

#6 *Broad-Based Dips (Swales)*

#7 *Open Top Culverts*

#8 *Shaping Roads and Trails*

#9 *Roadside and Diversion Ditches*

#10 *Cross-Drainage Culverts*

#11 *Project Closure (Deactivation)*

Crossing Options Series

#1 *Temporary Stream Crossings*

#2 *Fords*

#3 *Culverts*

#4 *Ice Bridges*

#5 *Timber Bridges*

#6 *Railroad Car, Steel, and Pre-Stressed Concrete Bridges*

#7 *PVC or HDPE Pipe Bundle Crossings*

#8 *Temporary Wetland Crossings*

- #9 Wood Mats
- #10 Wood Panels and Pallets
- #11 Expanded Metal Grating
- #12 PVC or HDPE Pipe Mats and Plastic Roads
- #13 Bridge Decks, Tire Mats and Pole Rails
- #14 Corduroy Crossings (Overlanding)

British Columbia Institute of Technology

Road Construction Practices and Procedures, Forest Engineering Technology
RRET 3310

Eric L. Kay, available for handbooks and training seminars, tel.: 250-337-5096 or e-mail
[erickay@mars.ark.com]

Workers' Compensation Board of BC, 1981.

Yarding and Loading Handbook,

FERIC, 1976. *Handbook for Ground Skidding and Road Building in the Kootenay Area of BC*,
Land Use Guidelines Access Roads and Trails, 1984, Supply and Services Canada

Holmes, D.C., 1984. *Manual for Roads and Transportation, Vol. One and Two*, B.C.I.T.

USDA Forest Service, NE Region, July 1998. *A Landowners Guide to Building Forest Access
Roads*, NA-TP-06-98

[www.na.fs.fed.us/spfo/pubs/stewardship/accessroads/accessroads/htm]

Geotextiles

Information: [www.state.me.us/mdot/planning/csd/geotext/htm]

Sources: [www.nilex.com]

Reclamation Seed

Sources:[www.dawsonseed.com]

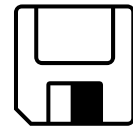

Harvesting the Trees

In this chapter...

Harvesting Is More Than Cutting Trees	123
When Do I Harvest?	125
How Much Do I Cut?	127
Harvesting Steps and Methods.	128
Small-scale Equipment	136
Environmental Considerations.	138
Scaling Requirements.	139
What Is A Timber Mark?	141
Working With A Logging Contractor.	142
Sample Harvesting Contract.	143
Recommended References	147

.....

Harvesting Is More Than Cutting Trees

Harvesting is one of the most important phases in the forest management cycle since it sets the stage for the creation of a new forest. If the harvest is not done properly, the subsequent management steps become focused on cleaning up or correcting damage done, rather than directed towards achieving an overall plan.

This chapter discusses the considerations and decisions related to primary harvesting. You will find information on when and how much to cut, as well as the different systems and logging methods you can use. The development of a logging contract is outlined and a sample contract provided. Also included is a discussion of how forest products are scaled and graded for sale after they are harvested.

Harvesting is a focal point in woodland operations, small and large. It is the major revenue generating phase in forest management and a key development activity in the woodland.

The decision to harvest is usually based on one or a combination of the following reasons:

- to replace one crop with another
- to cash in some or all of the value of the current crop
- to recover some otherwise natural mortality losses from root rot, windthrow or mistletoe
- to improve the quality and value of the current crop (see the chapter “Commercial Thinning”).

The process by which a forest is tended, harvested and replaced is called a silvicultural system. Silvicultural systems are classified according to the method by which you remove the mature crop and seek to establish the new one.

Even-aged stands are maintained by clearcutting, seed-tree and some shelterwood systems; and uneven-aged stands are maintained by selection system. Each of these systems represents a strategy for the complete cycle of the stand. The silvicultural system you choose will be based on consideration of the forest you have and the forest you wish to create as well as your own management objectives.

Like an iceberg, logging is the most visible result of your Forest Management Plan, and it is easy to forget that it represents more than what you see. Your harvesting schedule is, in fact, an expression of the following considerations:

- ***When to cut: (Crop Rotation)***
How old is the stand? How much can it be expected to increase in volume and value? How shall I decide whether to cut it now or later? Is natural regeneration planned, and if so, when is the next good seed year expected? What time of year do I harvest: in the winter on frozen ground, in summer when the soil is dry and stable?
- ***How much to cut: (Allowable Annual Cut)***
What are the harvesting objectives—stand replacement? Cash flow? Is the area being salvaged after fire, insect or disease infestation? What are the management objectives for the area regarding other uses? What are the constraints regarding harvest? Are there other economic, social or environmental issues to incorporate in your harvesting plans? Any fish-bearing streams, deer or elk winter range, visual quality objectives or community watersheds?

- **Which silvicultural system:**
Are the trees all mature or of varying age classes? Are there particular products ready for harvest? Is the stand healthy or are there pockets of disease or insects? Is the species mix appropriate for my personal goals?
- **Which logging methods:**
What are the terrain conditions? Are the soils subject to compaction or erosion? What is the average slope? What equipment do I have and how could it be converted for logging? How large is the area? What volume of timber will be logged? What access is in place? Is the appropriate equipment available with trained operators?
- **Which species to regenerate and by which method:**
What is the current species mix? Which species are appropriate to the site? Which species are favoured? What products are desired? What financial and time resources am I willing to commit? What are the cost and environmental implications of natural regeneration versus planting?

Note: The determination of rotation and allowable annual cut are made in consideration of the entire woodland area as part of your Management Plan. They involve careful consideration of your personal goals and the current inventory of the woodland. The other decisions are made for each Management Area, based on the development objectives you have set, the stand characteristics and the terrain in that unit.

The overall planning considerations of when to cut, how much, and according to what system will be discussed first.

When Do I Harvest?

Choosing when to harvest a stand will depend on a number of factors. Foremost is how the proposed harvesting fits with *your* management objectives. The age of the stand, its rate of growth, the financial needs of the operation or the unplanned interference of insects, disease or fire may all affect the harvest date.

The concept of stand maturity is a useful indicator of when to harvest. The biological maturity of a stand is the age at which the stand has reached its maximum rate of volume production, or when its average annual growth is greatest. To harvest before this point is reached means the loss of significant volume increase and value. To delay harvest beyond this point means that you retain a stand whose annual rate of growth is slowing down, but not stopping altogether.

Pathological maturity can be triggered by widespread insect or disease infestation. This means that the volume increment of your stand is very slow or could be actually negative.

Foresters refer to the point of optimum volume production as the maximum mean annual increment (MAI). The MAI is the average annual rate at which the stand has grown over its lifetime. It is usually expressed in cubic metres per hectare per year. The figure below depicts the growth of a stand over time, showing the total volume production and also the trend in MAI as the stand grows. The biological maturity is the point at which the MAI is greatest. This is also called the culmination point of MAI. The culmination of MAI is comparable to the point at which a teenager peaks in the rapid growth spurt that often characterizes puberty. Past this point both the teenager and the tree keep growing, though at a slower rate.

The Total Volume line in the figure is known as a 'volume-over-age-curve' (VAC). This curve represents the VAC for coastal Douglas-fir on a good site in the Vancouver Forest Region. VACs are produced by forest cover type, for different sites in forest regions throughout the Province and are available from the Inventory Branch of the Ministry of Forests. By drawing a straight line from the origin (0,0) on the graph, to just touch the edge of the VAC₁ it is possible to estimate the culmination point of the MAI. The age of the stand at this point is the biological maturity of that species on that site. To obtain the actual value of the MAI at this point you would divide the stand volume by the age. In this case the stand volume of 650 cubic metres divided by 70 years gives a MAI of 9.3 cubic metres per hectare per year.

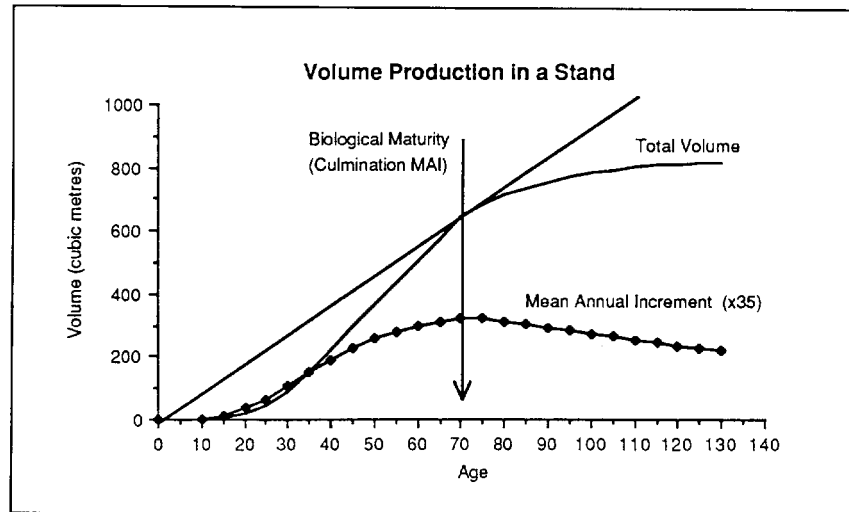

Foresters have traditionally used the biological maturity of trees as the minimum harvesting age for planning harvesting schedules in the province. The Ministry of Forests standards arbitrarily define 120 years as the mature age for most softwood species; and 80 years for lodgepole pine in the interior.

Long-lived tree species such as ponderosa pine, Douglas-fir or redcedar have not maximized their economical value at the time of biological maturity. The market value generally increases with log size so that additional value gains can be made at the expense of some volume losses (lower allowable annual cut), if the stand rotation would be extended beyond the age of biological maturity.

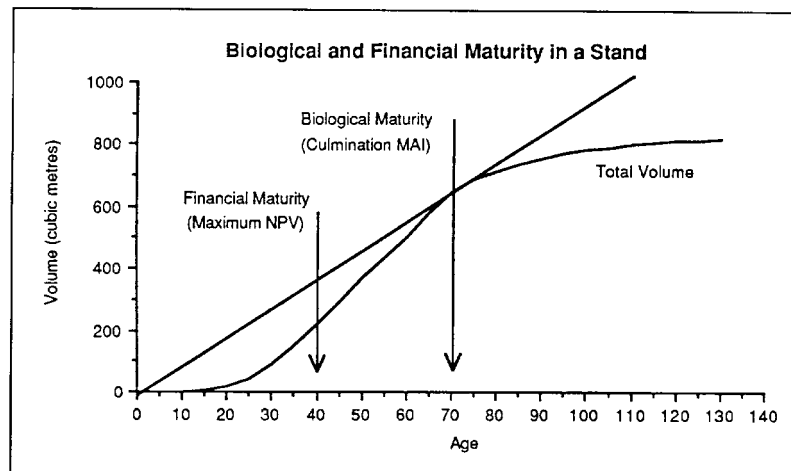

In practice, you will likely base the decision of when to harvest on a combination of factors, some biological and some financial (primarily the state of your bank account). It will depend on weighing the costs and benefits of cutting now, against cutting later. Ultimately, it will be influenced by your cash flow situation, and how badly money is needed, since the risks associated with holding onto the trees for a little longer are relatively small. Fire and a change in the market prices for logs and other products are the major risks, since even if the stand blew down or was hit by pests, you could salvage the logs.

Generally speaking, the stand becomes more valuable as it gets older, so you can afford to delay the harvest if it is not costing you money to hold the stand, and you have no financial constraints that make it necessary to harvest immediately. Selective cutting of some commercially valuable trees can be carried out to provide cash flow, while allowing the stand as a whole to continue to grow to greater value.

How Much Do I Cut?

The decision regarding how much to harvest will depend on the management objectives for the area, the age and condition of trees in the stand, and the desired next crop. Special circumstances, such as the need to salvage insect or fire-damaged trees will also influence the material cut.

If a tract of land is to be managed to produce a sustained yield, the manager will have to calculate an annual or periodic cut for the woodland. This calculation will provide a guide to harvesting, but flexibility is recommended. Economic conditions will prescribe cutting more during high market years and cutting less in low market years. In practice, the cut schedule will likely be periodic, rather than annual, for many small woodland areas. Every five years you should tally up your harvest volumes and find out if your average harvest volumes are on target or under or over.

Determination of the sustainable harvest rate or annual allowable cut (AAC) is an essential part of your Forest Management Plan. The potential exists for increasing the AAC for an area by carrying out stand tending activities to increase the rate of growth in stands that are not currently achieving their growth potential.

Once the AAC has been established for the woodland area, as well as rotation ages for the stand, you can turn your attention to planning at the Management Area level. This begins with a preharvest assessment, called the silviculture prescription/site plan (SP). It collects information on the site biogeoclimatic classification, soil depth, nutrient and moisture conditions, current conditions of windfall, advance regeneration, shrubs, insects and disease, and the characteristics of the current stand. This information is used to develop a prescription for the area, well in advance of actual harvesting, that indicates the appropriate silvicultural system, logging methods, season of operation, site preparation, reforestation method, species selection and follow-up treatment activities. Guidelines and forms for the silviculture prescription have been developed by the Ministry of Forests; for more information contact your local district office. Professional help is recommended when it comes to preparing your SP, but at least have the area and the prescription reviewed by an experienced forester.

Harvesting Steps and Methods

This section will provide an overview of the steps involved in logging, along with an indication of the level of effort and expertise required. Logging is dangerous work that requires a great deal of skill to do efficiently. Would-be loggers should seek the advice and assistance of others who know what they are doing, and can provide pointers on how to make decisions and how to be safe and effective.

The basic steps in logging are the same regardless of the size of the forest holding. The equipment used, however, will vary a great deal between the industrial and non-industrial woodland operator. Specific pointers are included for those of you interested in doing it yourself along with basic guidelines for those who will be shopping for a contractor.

A clear logging plan is essential to both do-it-yourself and contract operations. By coordinating the development activities on the ground, it can save you time and money. It can substantially reduce the extent of compaction, erosion, loss of productive area to unnecessary trails and landings, and damage to the remaining trees. A logging plan summarizes the way in which harvesting is to be carried out on a particular cutblock within a Management Area. It includes how felling and forwarding, or skidding will be done and with what equipment and how wood will flow from stump to landing. The logging plan is usually presented as a map showing cutblock boundaries, main and spur roads, primary and secondary skid trails and landings.

Timber harvesting involves six basic steps:

1. felling, or cutting of the trees
2. bucking the trees to logs of prescribed lengths
3. yarding or skidding logs to a central location
4. loading the logs onto trucks
5. hauling the logs to the sorting area or mill
6. slash disposal and site rehabilitation.

Each of these steps can be conducted in a number of ways, and use a variety of equipment. The method you choose will depend on the material you are harvesting, the site conditions, and the silvicultural system you are following.

Felling

For many woodland operators, felling and bucking will be the only logging phases in which they actively participate. This is understandable since these activities involve a minimum capital outlay for equipment and (unfortunately) are tasks that most of us think we can do with little experience or training. In reality, proper and safe felling is an acquired skill that calls for knowledge of equipment and trees, common sense, and good judgement.

Though commercial felling is being done more and more by machines such as tree-

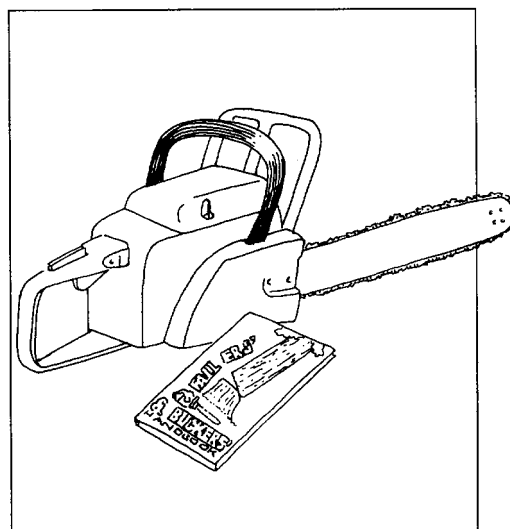

shearers or feller-bunchers, felling will likely be done most often by hand on small woodlands. The first consideration for many landowners wishing to do their own felling is the purchase of a chainsaw. For woodland work, a bar length of between 50 and 60 cm (20 and 24 inches) is recommended. The choice will depend on the size of trees you are working with and the extent of the work being done.

Safety in handling a saw is extremely important. In addition to protective clothing and equipment, knowing how to 'read' tree behaviour and how to protect yourself from common dangers such as limbs breaking, logs rolling and kickback are critical skills. The felling of trees and bucking of logs are special skills that will only be introduced here. You are strongly advised to obtain a copy of the 'Fallers' and Buckers' Handbook' produced by the Workers' Compensation Board (see references at the end of the chapter). WCB will offer courses to obtain faller's certificates. Always be careful and carry all required safety equipment, including a good first aid kit. Know when to ask for help.

Assessing Tree Behaviour:

- look for tree lean and which side has most branches. Fell within 45 degrees of the direction of the lean
- check for loose or dead limbs or tops that could break off during cutting
- check for signs of rot, such as conks. Remember that species like cedar, hemlock and balsam (grand fir, amabilis fir) are prone to heart rot in the lower trunk
- note any potential for hang up on other trees
- fell snags in the direction of lean; listen and watch for falling branches.

Do not fall the tree directly uphill on steep slopes, it can "run" away and take you with it.

Felling sets the stage for the harvesting operations. Careful planning and skill in directing the fall of the tree can reduce potential dangers and delays in hang ups, and breakage of

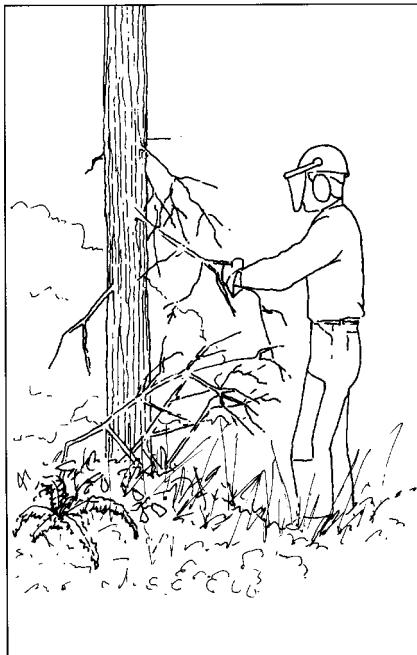

the tree as it lands. Felling should be planned to drop trees into openings, including skid trails, and away from fish-bearing streams and other watercourses, roads or boundary lines. Controlling fall direction can help to align the logs for more efficient (and environmentally sensitive) skidding operations. Correct felling is particularly important in selective logging since it affects the amount of territory the skidder must cover, which in turn affects the amount of soil compaction, potential for hang ups and damage to standing trees.

Danger tree, overhead hazards and snags need to be removed first, but you can save a lot of those important wildlife trees if you assess them according to the provincial Wildlife/Danger Tree Assessment procedure.

Proper Felling Procedures

1. Remove brush, debris and snags to clear a working and retreat space (at 45° to the direction of fall, and for a distance of about 6 m).
2. Form an undercut by first making a horizontal cut into 1/4 of the tree diameter. Next make an upward diagonal cut to meet the first cut. The fat end of the wedge created should be about 1/3 of the depth of the horizontal cut. The two cuts should meet but not cross at the inside edge of the cut.
3. The backcut should be level and slightly above the horizontal cut line of the undercut.
4. There should be enough 'hinge wood' to control the direction of fall.
5. Look up to check the tree as you work.
6. Use wedges to lever the tree to fall.
7. Do not turn your back until the tree has completed its fall.
8. After the tree is on the ground, wait a moment and look for branches or other debris to come down.

To use the most of the timber on your woodland you should cut to a stump height of not more than 30cm and a top diameter (inside bark) not more than 10 cm. The advantages are: better utilization of timber resources, decreased waste, reduced fire hazard and fewer slash disposal problems.

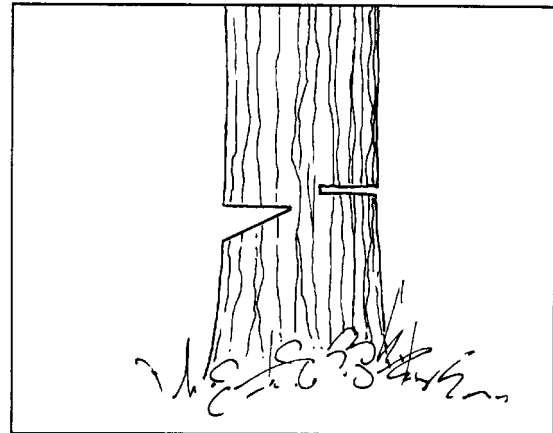
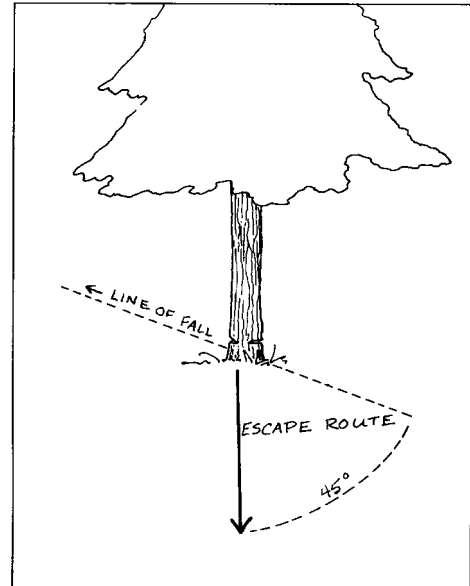

Bucking

Bucking is the first step in manufacturing, since it cuts the tree into merchantable logs. It is a significant activity that affects the potential value of the tree. Where felling is done by hand, bucking is usually done by the faller as well. As the tree is limbed, it is cut into log lengths of the greatest value. On the coast, bucking is normally done in the woods. In the interior trees are usually skidded full length to the landings where they may be bucked before hauling to the mill.

Bucking can actually improve log grade by removing defects or creating special products. With such an influence on log value, it is definitely worthwhile to learn about bucking specifications. Arbitrary or random lengths will easily devalue a log. If possible get your log buyer to walk the block or look at some full-length logs to recommend bucking lengths. Simple things, like square cut ends and accurate measurement to include trim allowances, can mean the difference between a high value and low value log. Each tree is

bucked on its own characteristics and should be carefully assessed before making the first cut. Bucking decisions are based on the tree's quality, distribution of knots, and a knowledge of current market values. When logs are bucked to length for a particular mill, it is important to know the mill's trim allowance requirements. Log buyers often have cards printed up with their desired log specifications. Be sure to carry this with you; bucking decisions made in the woods can radically affect the value of the log at the mill.

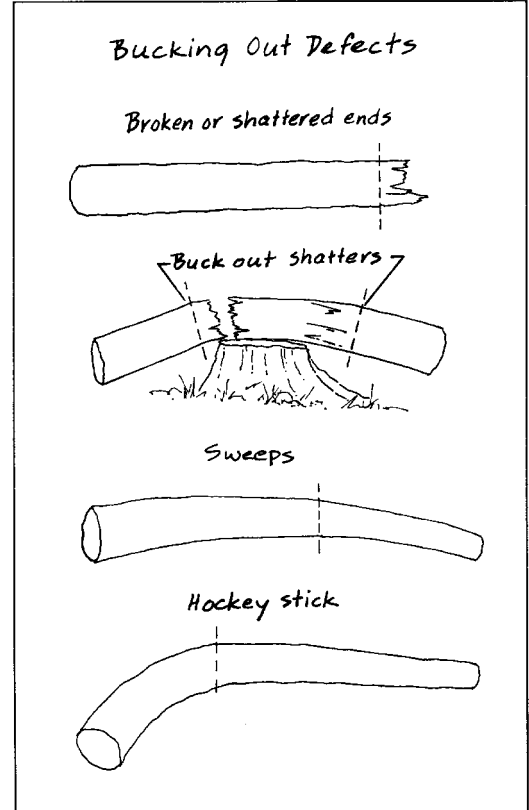

Bucking Pointers:

- buck from the uphill side of the tree
- assess each tree carefully and plan the buck before you cut
- beware of trees under tension that could rebound when cut
- buck from both topside and bottomside of the log to avoid splitting
- measure log lengths accurately, and include trim allowance
- cut log ends squarely
- buck out log defects such as breaks, splits or rot
- consult the buyer for bucking specifications before you cut.

Yarding and Skidding

Yarding transports the logs from the stump to a landing, or central area, usually at the roadside, where logs are loaded onto trucks. Yarding on the steeper ground is carried out by a number of systems that partially lift, rather than drag the logs to the landing. Mobile,

grapple yarders and tractor-mounted ‘spars’ or towers, use highlead systems that pull in logs by tongs or chokers attached, to a cable suspended in the air. Ground-based yarding is usually done by a hoe fitted with a grapple (hoe-chucking) as well as by skidders or crawler tractors that drag the logs by means of heavy wire cables, called chokers, or by a grapple hook. Skidding is also done with draft animals such as horses and more recently with special winches designed for small-scale operations.

Trail Design

As with felling and bucking, yarding is most successful when it has been planned in advance. The location of skid or forwarder trails is the key to an efficient and environmentally sound yarding operation, and they should be laid out with flagging tape to provide direction to construction. Yarding patterns should not cross fish-bearing streams or other watercourses. The area covered by trails should be kept to a minimum as heavy machinery compacts soil and can reduce its productivity for growing trees. Excessive disturbance can lead to erosion problems, the loss of soil nutrients and the potential deposit of silt in watercourses.

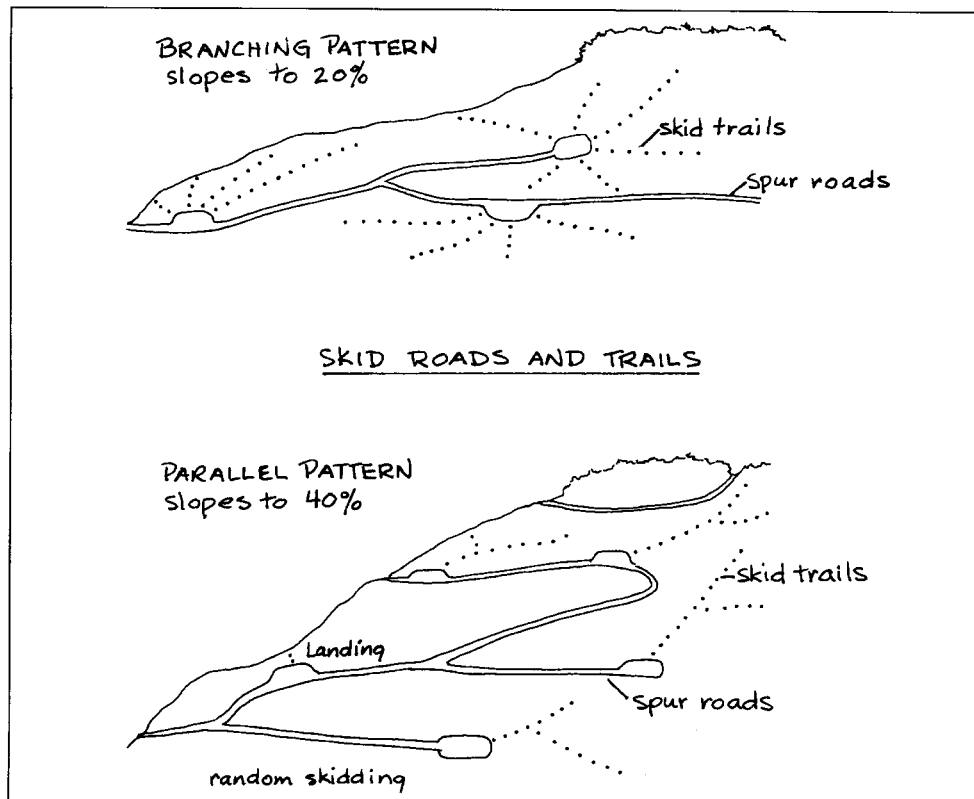

Trails should be located in advance of harvesting to fit the terrain and establish a defined network. If yarding is done on a random basis, (no planned trails) then the amount of soil degradation is usually significantly higher than with a designated trail system.

On average trails should be located to have 40–50 m spacing although this will vary with terrain and forest cover characteristics. Spacing should minimise the amount of trails but maintain yarding efficiency. The trails should be positioned to remove all accessible timber and provide logical haul patterns to the landings without logs hanging up or sliding into stumps or standing timber. Mark rub trees adjacent to the trail and on corners. These will be gouged and skinned but will protect the remaining crop trees. The rub trees

will be felled and yarded at the very end of the work. Ideally trails should be laid out and constructed with other long-term use in mind: to provide the woodland with a system of access for planting, stand tending operations, recreation and other purposes.

Landings should be located first when planning a ground skidding or forwarding operation. They should be central to the trail pattern in areas of heavy timber concentration, and there should be enough landings to keep yarding distances between 250 and 400 metres. Landing size should be kept to a minimum (preferably to less than 30 m by 30 m) to reduce loss of growing site. Flat sites with good drainage, such as knolls or benches, are preferred. When clearing the landing, it is advisable to fell a safety buffer around the landing site. If this is not possible, be sure to at least remove any unsafe snags within that distance.

To minimize soil compaction, the use of wide tired skidders or tracked machines are recommended, especially on poorly drained or sensitive sites. Soil impacts can also be minimised or avoided by harvesting in the winter and therefore skidding over frozen ground or heavy snowpack conditions. In conditions of greater slope and terrain variability, it is advisable to construct proper trails.

For slopes of less than 20%, a branching pattern works well. Spur trails branch off main trails as illustrated. A parallel pattern is also appropriate for both simple terrain and on side slopes up to 40%. The main trail should always be downhill. The spacing between trails will depend on tree height and size as well as the size of the skidder winch. On the medium and steeper slopes it is important to minimize the crossing of creeks, ridges and gullies, since this will disrupt natural drainage patterns and increase site disturbance.

Wherever possible, trails should be built downhill, from the top to the base of the cutblock. Long, steep, straight grades permit water buildup and erosion and should be avoided. Maintenance of trails usually involves keeping the surface water drained away with water bars and trenches.

Skid Trail Layout and Construction

- follow the terrain as much as possible and avoid sharp curves
- for steep terrain, place trails parallel to contour lines to prevent erosion
- ground skidding is usually confined to slopes under 35%
- cut stumps on skid trails to ground level to prevent hang ups, but leave 1 metre stumps along the outer side of the trail to prevent slide-outs and to protect crop trees
- avoid wet spots and springs
- where trails must cross water seepages, they should be at right angles and on gravel or rocky locations, Place logs in the seepage area to provide a travel surface for equipment and minimize ground disturbance
- trails should be no wider than necessary for the tractor or skidder
- lay out skid trails for easy entry to landings; avoid sharp curves and junction corners.

Equipment Selection for Ground Skidding

Three main types of equipment are used for ground skidding; the selection of which to use is based on the terrain and size of timber. Rubber-tired skidders are suited to gentle terrain with slopes up to 30%. Skidders equipped with a winch and chokers are used in conjunction with hand fallers; while skidders with grapple-mounts are used with feller bunchers. High flotation tires are being used on skidders operating over soft and wet ground to minimize soil compaction.

Small and medium-sized crawler tractors (maximum 150 HP) are suited to skid trail construction and skidding short distances. They are more effective than rubber-tired machines for working on medium steep slopes (up to 40%), soft ground, and in deep snow. The special low ground pressure (L.G.P) tracked skidder is designed for use on wet, soft ground or deep snow at slopes of up to 50%.

Hoe chucking the logs to the road or landing has become popular. This method is very efficient and requires only a mid to large size hoe (excavator) with a grapple instead of a bucket mounted to the boom. The preferred yarding distance is up to 150 m, while the generally low ground pressure of the excavator tracks helps to reduce soil degradation. Compared to most of the other machines, excavators are multi-purpose tools (the boom is a quasi extension of the operator's arm) that are able to complete many woodland tasks, just with minor conversions. Fitted with a felling/processing head, excavators can even conduct the falling and bucking steps of the harvesting process.

Many small woodland managers use farm tractors in the forest to yard and skid trees. This equipment can be effective and be used for multiple purposes although some modifications are required for use in the forest environment. A variety of special equipment both for ground skidding and cable yarding designed for the part-time operator is available in BC. Refer to the section on *Small-scale Equipment* later in this chapter.

Loading

Loading operations in the woodland are usually carried out by logging trucks, equipped with hydraulic hoists or booms to make them self-loading. Otherwise, a separate loading machine (usually a hydraulic excavator with grapple) will be necessary to load logs onto the truck. Make sure you have a landing or turnout close to the end of your road so that the logging truck can turn around before loading and does not need to back-up for a long stretch of road.

Hauling

Hauling and loading is often contracted out as a separate operation from other aspects of harvesting. It is a costly activity that is affected by road surface and design, landing organization and loading efficiency, not to mention the distance to the mill or log dump.

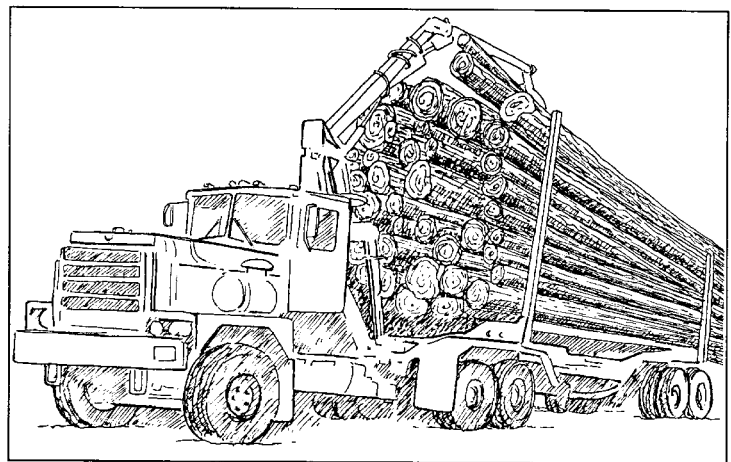

Since haul costs are often a large portion of logging costs, and can be reduced by careful planning, it is recommended that you seek some professional advice with respect to road and landing layout before you start building.

Slash Disposal and Site Rehabilitation

After logging, the slash material (wood residue) left on-site may have to be removed to reduce the fire hazard and/or to prepare the area for reforestation. This may involve spot burning of accumulations on areas such as landings or roads. It also may involve ‘slashing’ the residue so that it lies flat to the ground. This will accelerate its decomposition and make the area easier to plant.

A third alternative is to construct slash piles scattered across the cutblock and the adjacent standing and thinned timber. Often these ‘mega-compost piles’ will provide habitat for small birds and mammals. Trees planted up against the pile may grow more rapidly as the pile provides nutrients and conserves moisture. If the piles are designed and located correctly, there should be only a minor loss of planting spots. Within twenty years, the canopy of the new crop will meet and cover the pile, which will be greatly diminished by this time. If, as a last resort, burning is to be carried out, the construction of firebreaks and other safety measures will be necessary and burning permits will be required. Slash associated with road building should also be disposed of either by burning or burying. If buried, it should be clear of the road construction area, but not underneath it. Vegetation is not a stable fill base to support a road.

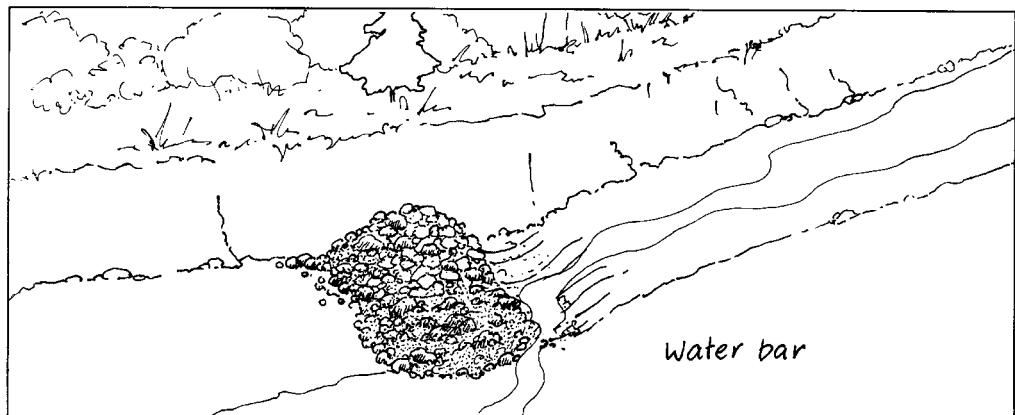

After logging, skid trails and other abandoned roads should be ‘water barred’ to channel water away from the road surface. This can be done by angling small ditches, 10–15 cm deep, at intervals across the road surface to channel water into the side ditches or directly onto the forest floor. Landings should also be treated after logging is finished. Due to the high volume traffic that a landing supports, soil becomes very compacted during the logging operation. Landings may have to be ripped or scarified to loosen the soil to improve its drainage and encourage revegetation. All non-active roads and landings should be seeded with grass to minimize soil erosion.

Small-scale Equipment

With the growing interest in small-scale woodland operations, there is a need for the production of appropriate small-scale equipment. Individual owners scour the market for small crawlers and skidders, or modify farm tractors for forestry tasks such as yarding and site preparation. The development of the self-loading logging truck has revolutionized small-scale operations by making it economically worthwhile to recover small volumes of material—even one or two truckloads.

Sweden and Finland, longtime practitioners of small-scale forestry, have developed a number of small-scale systems for logging and silvicultural practices. The Swedish *Small Scale Forestry* magazine is full of useful information and equipment ideas applicable to small-scale operations. Also highly recommended are *The Farm Tractor in the Forest* and *The Chainsaw – Use and Maintenance* handbooks produced in Sweden, and published and available in Canada through the New Brunswick Department of Natural Resources (see the recommended references).

If you are thinking of modifying basic farm equipment for forestry work such as skidding or site preparation, keep safety in mind. While it may be possible to make do with a tractor for skidding a few truckloads of small logs on flat ground, it can be inefficient and even dangerous on slopes or with larger material. Tractors have a high centre of gravity, become unstable on slopes, and can be pulled over backwards under some circumstances when hauling heavy material.

The Forest Engineering Research Institute of Canada (FERIC) has produced a number of excellent publications on woodlot technology (references at end of chapter). One report compares seven 4-wheel drive tractors and skidders that are currently in use or available for use in small woodlots. Particularly useful for the small operators who manage their woodlands on a part-time basis is the *Handbook For Logging With Farm Tractor-Mounted Winches*. A Canadian-developed tractor mounting winch, the *Agri-Winch* is reviewed for woodland operations in another study.

Forwarding trailers can be used with a properly equipped farm tractor to move logs from the bush to a landing. These normally have a grapple loader for lifting the logs onto the trailer. Forwarders are especially favoured if you are milling the logs with a portable bandsaw, as the log are transported off the ground and have little gravel, rock and other blade-dulling material in the bark.

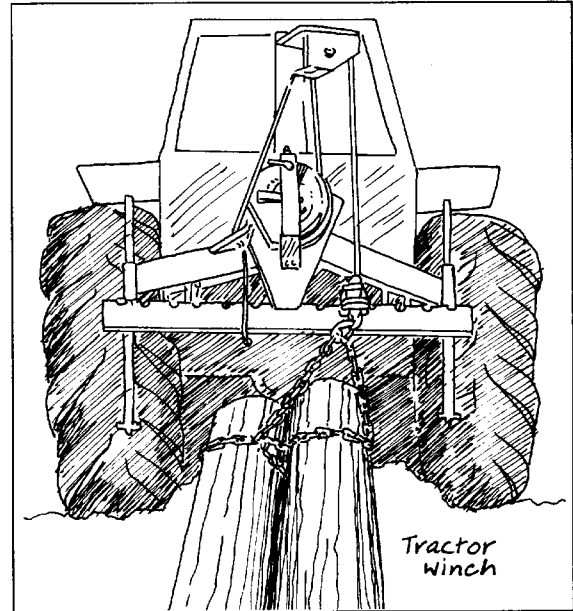

For those of you without even a tractor, don't despair. *Small-motorized winches* that can be attached to a tree to winch-skid cut products from your woodland are also available. The successful use of these light winches depends on careful felling and alignment of cut materials for skidding. They have been used successfully in small clearcut operations but are really

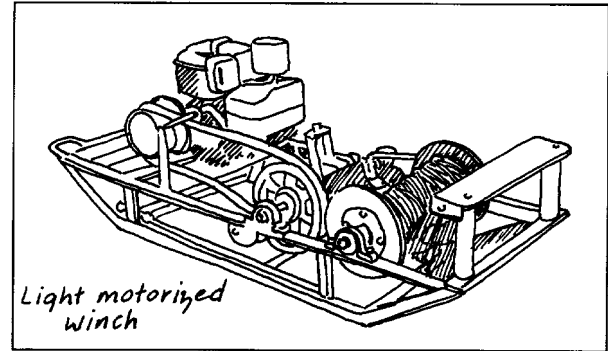

making their mark in selective cutting and thinning operations. See *Harvesting Trees From Thinnings Using Small Winches*. There is even a double-drum winch on the market, powered by a chainsaw, that is advertised as a portable yarder with haulback!

Tower cable systems mounted on small excavators and truck-mounted portable spars and grapple systems have started to fill the special equipment needs of small-scale operators. They are especially useful for logging sensitive areas, wet areas, and for thinning operations. Some equipment dealers are beginning to develop particular expertise in small-scale processing machinery, such as portable sawmills, chippers and fuelwood processing systems as well.

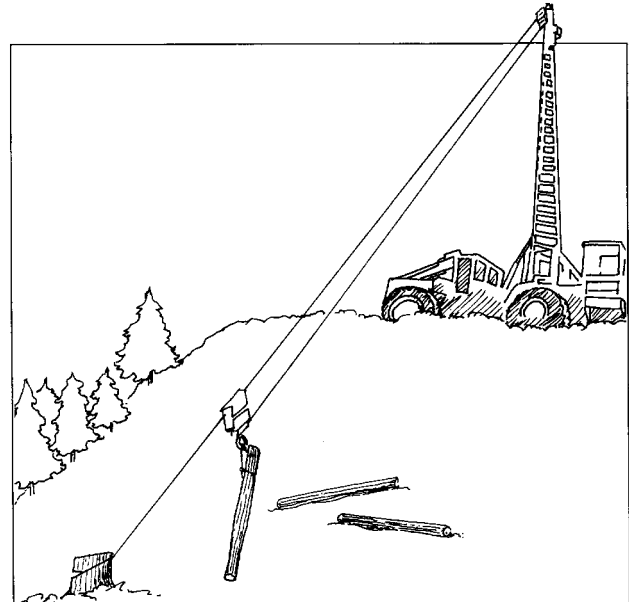

Contact your nearest woodlot association or local equipment dealers for further sources of information.

Horse logging is growing in popularity as a low-impact means of extracting material from small woodlands and

sensitive areas. The method minimizes soil disturbance, compaction and soil erosion as well as damage to the stems and root systems of standing trees. It can, however, be a dangerous activity for the novice, since the operator is physically close to the logs and cables. Approach it as another equipment decision. The Cariboo Horse Loggers Association should be contacted for further information on the costs and benefits of horse logging.

The choice of equipment to do your job will usually depend on the answers to a few standard questions:

- What is the job I want to do?
- What different ways and with what different equipment can it be done?
- Are the equipment and trained personnel available?
- How do each of the alternatives compare in terms of the amount of my time that is needed? The amount of capital cost? The risks involved? The quality of the completed task?

Environmental Considerations

Consideration of the environment and other resources must be incorporated into all aspects of timber harvesting operations. Proper planning before harvesting should be followed by close supervision of operations on the ground. Trails and yarding patterns on steep ground should be designed to minimize the effect of surface water flows and prevent high traffic areas, such as landings, from turning into mud ponds. Wet sites can be scheduled for logging in winter when the ground is frozen and the impact of machinery is minimized.

The Forest Practices Code (FPC) guidebooks were developed for a multitude of forestry topics to minimize environmental impacts. As the standard of the day they cover recommended procedures for felling and yarding, road and trail construction, and the treatment of streamside (riparian) areas to minimize sedimentation and maintain the health and character of stream banks and channels. In addition to these specific considerations, however, the following overall guidelines for harvesting operations are recommended:

- protect fisheries sensitive zones and other sensitive areas or unique features including wildlife trees, dens, saltlicks, recreation trails and archeological sites
- evaluate impacts of harvesting operations on down-stream values
- evaluate landslide and erosion hazards and use special methods as required
- use appropriate yarding systems for the site; yard uphill where practical
- assess ground skidding systems carefully for use on slopes greater than 30%
- avoid continual and random stream crossings with skid trails
- maintain stream bank green strips to provide shade and nutrients for fish
- leave some large trees (standing and down) along fish-bearing streams to maintain stream bank stability and the distribution of pools and riffles that are important as hiding cover and protection for fish during periods of extreme stream flow
- prevent introduction of debris into streams; carefully supervise stream cleanup while maintaining requisite large woody material in the stream
- perform equipment maintenance well away from streams or wetlands
- collect and remove all waste materials from the site for proper disposal (used motor oil and oil filters can usually be disposed of at your local fuel supplier)
- keep a basic oil spill kit on site to help cleanup any spills
- locate portable fuel tanks and oil pails in a location where they are away from and protected from working machinery.

Along with environmental considerations, harvesting operations should be sensitive to the public environment in which they take place. This is especially important for small woodland owners in BC whose forest properties are often located in the rural and urban interface – that is close to neighbors and local communities. Skid trails, landings and cutblocks should be kept free of refuse, fuel containers or cables at all times. Consider the use of visual buffers to reduce the visual impact of your operations to neighbours and passers by. This is worth considering even for small clearcut blocks. *The Forest Landscape Handbook* published by the Ministry of Forests is a guide to help people lay out and position harvesting blocks in a manner that is sensitive to the viewer. In most cases the costs of going the extra mile in terms of layout and buffer strips are well worth keeping neighbours and others in your community happy.

Scaling Requirements

Scaling involves the measurement of the volume and grade of all timber and special forest products harvested. **All timber cut from private and Crown lands in BC must be scaled and marked.** Scaling requirements for small woodlands may vary according to

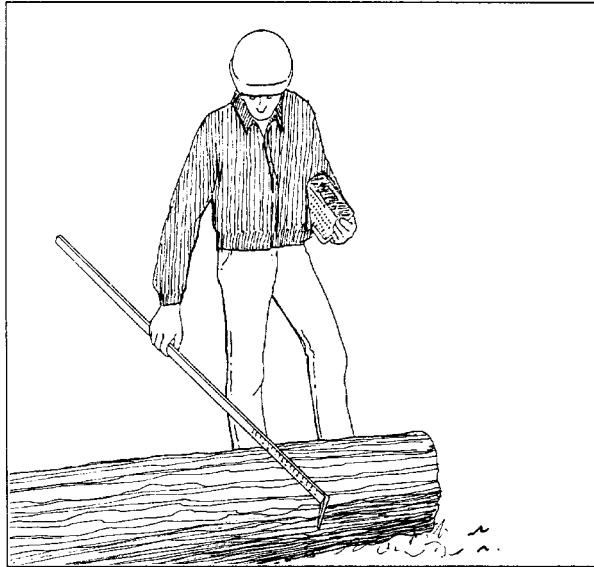

special regional or individual circumstances and the volumes and types of products involved. The district manager of the Ministry of Forests is the scaling authority and should be contacted to determine the requirements for individual properties. The district scaling officer will work out the basis on which volume will be estimated and the format for reporting. In general, the requirements become less stringent as the volume and value of the wood logged decreases. In some cases, minor volumes (less than 3000 m³) may be exempted from scaling, and instead, the woodland operator may

be required to submit a monthly statement to the district office summarizing the volume cut. Check with the Ministry of Forests before you harvest!

Scaling is carried out by independent scaling firms or licenced individuals authorized by the Forest Service district manager. The *Forest Act* and regulations sets the standards and procedures for scaling, and the Ministry of Forests carries out monthly check scaling of all scalers and establishes the conditions under which scaling is done.

All woodland operators are required to obtain a registered timber mark (see Timber Mark section) for logs cut from their woodland to identify the wood for scaling purposes.

How Is Scaling Done?

Piece Scaling

Piece scaling in British Columbia is carried out according to the BC Cubic Metric Scale that measures the firm-wood content of the log. This is done by measuring the length of the log and its top and butt diameters (inside bark). This gross volume can be measured with a carpenter's rule, and calculated using the illustrated formula.

Licensed scalers use a scaling stick, which is marked with a number of scales enabling the scaler to calculate log volumes as cylinders, based on measurements of the length and radius of the log. The scaling regulations and procedures are set out in the provincial *Forest Service Scaling Manual*. This document, as well as a set of tables of volumes of cylinders (which will allow you to calculate your scale volume without using the formula) are available from the Ministry of Forests.

Weight Scaling

Another form of log scaling in the province is *weight scaling*. Weight scaling is a quick and convenient way of measuring wood quantity but is somewhat less accurate than the solid volume scaling method. It is well-suited to homogeneous log profiles and pulp logs and is commonly used by mills in the interior at the point of delivery. As a rough guideline, a standard highway logging truck (maximum 2.6 metre bunk) holds approximately 30 cubic metres of wood.

How Are Logs Graded?

Scaling provides you with a measure of the volume of wood logged from a stand, but you will also be interested in the value of the wood removed. The value of logs is determined through a process called grading, which assigns value according to the species, size and condition of logs.

On the coast, all logs are graded when scaled, and are bought or sold by grade category for each species. Most interior mills grade logs by species and size. Both the Ministry of Forests and the Council of Forest Industries prepare monthly, quarterly and annual summaries of log sales by grade.

The formula treats the log as two cylinders and the log volume is based on the averaged volume of the two:

$$\text{Volume (cubic metres)} = (r_1^2 + r_2^2) \times L \times 0.00016$$

where: r_1 = radius of the top in cm
 r_2 = radius of the butt in cm
 L = length in metres
0.00016 is a constant

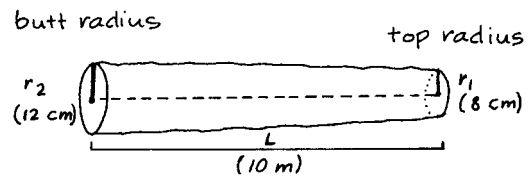

For example, to compute the volume of a log 10 metres long, with a top radius of 8 cm and a butt radius of 12 cm:

$$\begin{aligned} V &= (8^2 + 12^2) \times 10 \times 0.00016 \\ &= (64 + 144) \times 10 \times 0.00016 \\ &= .333 \text{ m}^3 \end{aligned}$$

Note: All radius measurements are taken to the nearest even number (so 8.5 cm would be recorded as 8 cm; 13.5 cm would be recorded as 14 cm). Lengths are recorded to the nearest 0.2 m, rounded to the nearest, lower even number (a log of 11.5 m would be recorded as 11.4 m). Deductions are made at the time of scaling by reducing the actual radius or length measurements for rot, holes, charred wood or other defects to the log.

A great number of things affect the grade of a log: growth rate, the form or shape of the log, the presence and size of knots, rot or insect damage, and the size of the log. A set of scaling rules sets out, by species, the characteristics of logs in each of the grade categories. For each category there is a 'grade rule' that describes the characteristics of logs and a specific listing of the log requirements to make the grade.

Because grade is associated with the presence or absence of criteria and the actual size of the log (length and top diameter), it is possible to modify the grade of any given log by bucking it into separate log segments. You can literally increase the value of a log (tree) by how you buck it. Whether you plan to buck the logs yourself or sell the stand to a contractor it is very important as the woodland owner that you learn about the log grades to be sure that you get the best value from your logs. When you realize that a high grade log can be many times the value of a low grade log, it makes sense to buck very carefully.

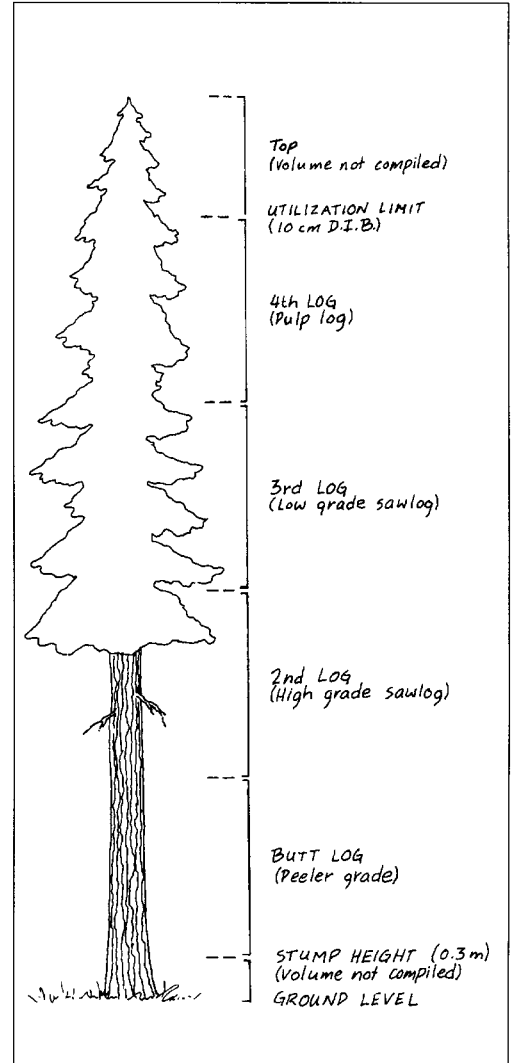

What Is A Timber Mark?

Timber marks, like cattle brands, are registered symbols that indicate where a log comes from, who holds the mark, whether or not the timber may be exported in log form, and whether the wood is to be charged stumpage or royalty fees. **Registered timber marks are required for all timber cut from Crown and private land**, and are issued upon application and payment to the Ministry of Forests. After an application is approved, the operator will receive a timber mark certificate with his assigned timber mark. You then contact a local foundry to make the hammer with the mark.

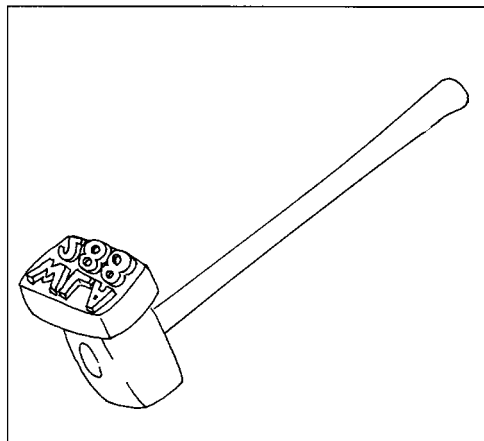

Timber marks are hammered into each end of a log. Woodlot Licences are marked as shown, with the letters 'W,' followed by four numbers and a letter which identify the licensee. The timber marks for wood from private lands have five letters. The first of these will be either an 'E' or 'N,' indicating whether the timber is 'exportable' or 'non-exportable.' The remaining four letters are a unique series that are assigned to the timber producer for that specific parcel of land. Although there are some exemptions, timber

from Crown lands may not be exported. Timber may be exported from private lands in some cases, depending on such things as when the land was Crown-granted. Indian Reserves are federal lands, and timber from these lands is exportable in log form and is free from royalty payments. The timber mark for Indian lands begins with the letters 'IR,' followed by three numbers designating the Indian Reserve from which the timber comes.

W56
47A

IR
176

Working With A Logging Contractor

Put your handshake in writing.

In addition to a clear harvest plan, your best friend in dealing with a logging contractor is a clear and comprehensive logging contract. The contract should clarify such things as:

- the basis on which payment is to be determined (i.e., flat fee, hourly, or dollars per cubic metre)
- logging methods, season and period
- standards and guidelines to be followed (e.g., utilization, bucking specifications, streamside protection)
- cleanup responsibilities, site preparation or regeneration responsibilities, road construction or maintenance
- how performance will be assessed and whether there will be a holdback on payment, pending suitable performance
- termination of contract if work is unacceptable.

You may contract out all of the harvesting operation or as phase packages, such as road development, felling, yarding and harvesting. Be diligent in selecting a contractor. It is better to spend the time at the start in making a careful selection than in coping with an unsatisfactory job after the fact.

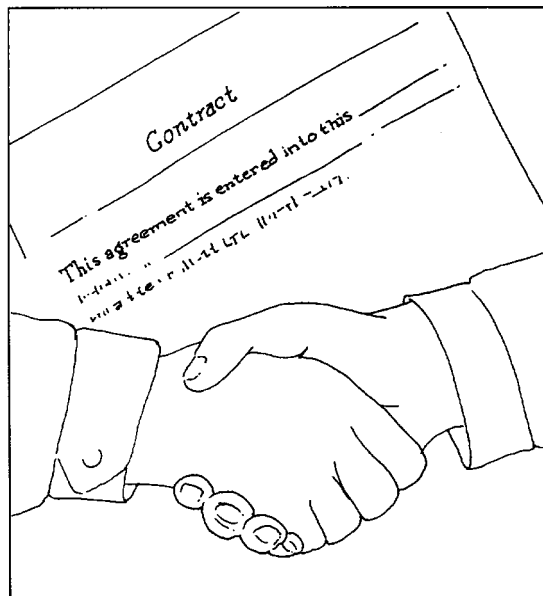

References from previous clients are your best indication of contractor performance.

Be honest and open with the contractor regarding your priorities and concerns. Discuss all contract requirements and preferences with the contractor before you agree to a price. Have a signed contract detailing all agreements before work begins and be on-site for major phase activities, such as felling and yarding in sensitive areas, as well as random checks on performance. Make it easy for the contractor to reach you with any questions or concerns; if you are not available and he has a deadline to meet, work will proceed without your input.

If you are contracting out operations such as selective harvesting or thinning operations where success depends on good on-site judgement, consider marking all the selected stems at dbh and stump height—a wrong selection can undo the work and investment of many years of effort.

The details of a logging contract will vary for each situation. A sample contract is included at the end of this chapter that will give you a good starting point from which to develop a contract specific to your needs. You are advised to seek legal advice before signing anything—especially the first time around.

Once logging has taken place, the material that has been cut will be scaled to measure its quality and quantity. Scaling is important since it is often the basis on which you will pay your contractor and the basis on which you will receive payment for your forest products.

Sample Harvesting Contract

The following contract is a sample format for your consideration. Note that a contract should be adapted to the particular requirements of each situation. In addition to the items addressed in the following sample contract, you may wish to provide for: Additional Work, Directions to the Contractor, Representations, Curtailment, Special Provisions, Insurance, Assignment and Subcontracting, Default by Contractor, Insolvency of Contractor, and Termination. You are advised to seek legal counsel regarding your contract documents.

LOGGING CONTRACT

THIS AGREEMENT made the _____ day of _____, 20__

BETWEEN A.B. Cee

(Hereinafter called the “Owner”)

OF THE FIRST PART

AND XYZ Logging Ltd.

(Hereinafter called the “Contractor”)

OF THE SECOND PART

WHEREAS the Owner wishes to carry out logging activities on portions of District Lot 000 as described hereafter.

AND WHEREAS the Contractor agrees to carry out logging activities on portions of District Lot 000 as described hereafter in accordance with the terms and conditions set forth in this Agreement.

NOW, THEREFORE, THIS INDENTURE WITNESSETH that the parties hereto agree, each with the other, as follows:

1. AREA

The Contractor will confine logging activities to block XXX of the District Lot 000 as shown on the attached harvest and road map. It is the responsibility of the Contractor to be familiar with the legal property boundaries, road location, parking area location and

other falling boundaries. Under no circumstances, the Contractor is allowed to trespass onto neighbouring property.

2. FIRE REGULATIONS

The Contractor agrees to comply with all Provincial Government regulations relating to the safety and security in respect to fire or other hazards, and that during the fire or dry season, April 1st - October 31st, unless otherwise specified by the Ministry of Forests, will take all precautions prescribed by Forest Practice Code of British Columbia Act or the regulations thereunder, or as may be specified by the Owner, and shall cease work if the Licencee deems it necessary.

The Contractor agrees to supply and keep on site the appropriate fire fighting equipment as required by the regulation for crew size, small and large engines and to follow the shift/shutdown schedule of the Ministry of Forests in _____ for this area.

The Contractor agrees to have a person in charge present on the work site for the duration of the road construction who has been trained to a level acceptable to the Ministry of Forests in areas of fire suppression techniques, fire behavior and fire line safety.

3. LOGGING

This contract shall not be assigned, subcontracted, or transferred in whole or in part without written consent of Owner. The Contractor shall furnish all equipment, tools, labour, transportation, operating supplies and other facilities necessary to complete the work described herein to the satisfaction of Owner within the stated period.

The Contractor shall fell, limb and buck into logs all trees, which qualify as harvestable trees and will comply with the standards as per Schedule "A" attached. All logs or trees shall be limbed and topped prior to yarding or skidding. Utilization will be a maximum of 30 cm stump height, 10 cm top diameter inside bark and a minimum log length of 3 m.

The Contractor shall manufacture the trees into merchantable logs according to the bucking specifications and standards provided by the Owner. Merchantable logs are defined as logs containing at least 50% sound wood and of greater than a minimum top diameter (inside bark) or minimum slab thickness of 10 cm and a minimum log or slab length of 3 m.

Slash piles of less than 50 m² can be left within the block to provide Coarse Woody Debris. Dangerous snags are to be felled and left on the ground, marked with the letters "CWD" in orange paint. Legacy wood that is on the ground for more than 5 years and qualifying as log, is to be left on the ground, marked with the letters "CWD" in orange paint.

"Rub" trees are to be left standing along the sides of the thinning corridors until final yarding or skidding takes place in that corridor. Thinning corridors shall not exceed 4 metres in width. Skid trails are to be protected by branches tree tops and other puncheon. The locations of the skid trails are to be approved by the Owner before operation commences. If ground based equipment is used, the Contractor is required to suspend work if the ground is wet.

4. SLASH DISPOSAL/WASTE

The Contractor agrees that all slash, logging debris or waste resulting from the Contractor's operations will be disposed of by the Contractor to the satisfaction of the Owner. Littering is prohibited in the area of operation.

5. OWNERSHIP

All logs produced from District Lot 000 belong to the Owner.

6. ROADS

The Contractor shall maintain and repair, as necessary, all roads used by the Contractor.

7. TIMBERMARK

The Contractor shall use the timber mark as supplied by the Owner (_____) and hammer stamp all log ends, at both the front and back, as well as paint the timber mark on the side of each truck load. The Contractor shall provide the logging truck operators with the appropriate load slips and retain a completed copy on behalf of the Owner.

8. TIMING

Logging shall commence on _____, 20____, and shall be completed, including the delivery of logs by _____, 20____. It is agreed that time is of the essence hereof.

9. PAYMENT

The Owner agrees to pay the Contractor:

\$ _____ /m³ of logged and scaled timber,

- (i) within 30 days minus 15% holdback.
- (ii) within 30 days of inspection after contract completion the remainder (15% holdback) upon notification of WCB clearance less any amounts necessary to repair damages to access roads, repair or collect penalties related to logging damage and to leave the area in a workman-like manner in keeping with good standards of logging practice.

10. FIRST AID AND EMERGENCY PLAN

The contractor shall, provide at all times of any operations under this contract a First Aid Attendant with adequate and up to date training required for the particular crew size and work hazard class. The contractor shall further provide as per WCB regulation all required means of communication, First Aid supplies, Safety Equipment and Emergency Transportation Vehicle. Prior to commencing the work under this contract, the contractor shall to the satisfaction of the owner and WCB officer prepare and carry an Emergency Response Plan with a list of emergency procedures, contact numbers, frequencies and back-up procedures. The contractor shall notify WCB within three days of commencing the work of the location of the work site.

11. APPLICABLE LAWS

The Contractor shall, while performing the work hereunder, observe and perform (and pay and satisfy all assessments or remittances pursuant to) the provisions of the Workers' Compensation Act, Employment Standards Act, Unemployment Insurance Act (Canada), and the Canadian Pension Plan (Canada), and regulations thereunder, and the hours of work laws and minimum wage laws of British Columbia and all other Governmental regulations, statutes and orders (including obtaining all permits or authorizations) pertaining to or having a bearing upon the Contractor's work hereunder, and shall indemnify and save harmless the Owner in respect thereof.

The Contractor's WCB No. is _____

(The Owner has confirmed by phone that the Contractor is in good standing with WCB)

12. LIABILITY

The Contractor shall indemnify and hold harmless the Owner and/or any third parties from any and all loss, costs, damages, expenses and claims of every nature whatsoever arising from any fire caused by the negligence of the Contractor or any breach of or failure to observe any Provincial, Federal, and Municipal Government laws, regulations or instructions.

The Contractor shall carry \$2,000,000 Comprehensive General Liability including a minimum \$500,000 for Forest Fire Fighting Expenses.

The Contractor's policy No. is _____ with the following Insurance Company: _____ in _____.

(A copy of the policy has been retained by the Owner)

13. TERMINATION

This contract will be terminated upon any of the following conditions:

- a) Unsafe work practices as identified by WCB or the Licencee including use of alcohol or drugs on the worksite.
- b) Failure to respond to directions given by the Licencee to the Contractor or their employees or Sub-Contractors.
- c) Failure to comply with any of the provisions of Sec. 11, Applicable Laws.
- d) Failure to commence work under this contract within 2 weeks of date in Sec. 8, Timing.
- e) Failure to comply with any standard of this contract.
- f) Failure to avoid, in the opinion of the Owner, environmental damage.

14. ARBITRATION

In the event that any dispute arises between the parties hereto which cannot be reasonably settled, the dispute shall be settled by a single arbitrator appointed pursuant to the Commercial Arbitration Act. Both Owner and Contractor shall be bound by the arbitrator's ruling, and shall pay equal portions of any expenses incurred.

15. NOTICE

For the purposes of this Agreement, notice shall be deemed to be given to the Owner at

(Owner's address), and to the Contractor at

(Contractor's Address), or to such other places as shall be from time to time substituted in writing, and such notice shall be deemed to have been received when delivered by hand or forty-eight hours from posting by registered mail from any post office within the Province of British Columbia.

IN WITNESS THEREOF the parties hereto have executed this Agreement.

Date: _____

Owner: _____

Contractor: _____

Recommended References

Small Woodlands Program of BC

A comprehensive 'Small Woodlands Library' is available on the web [www.swp.bc.ca]

Canadian Forest Service

Pacific Forestry Centre

506 West Burnside Road

Victoria, BC, V8Z 1M5, tel.: 250-363-0600, fax: 250-363-0775

[www.pfc.cfs.nrcan.gc.ca]

Publications on many forestry-related topics are available on request from the on-line bookstore at [<http://bookstore.cfs.nrcan.gc.ca>]

BC Ministry of Forests and Lands

BC Coastal Fisheries Forestry Guidelines, 1987. MOPL, DFO, COFI

Managing Young Forests as Black-tailed Deer Winter Ranges, 1987. Land Management Report No.37

Timber and Mule Deer in Management Coordination on Winter Ranges in the Cariboo Forest Region. 1986, Handbook No.13

The Forest Landscape Handbook, 1981. Publication 022-81008

Ground Skidding Guidelines, 1987. Engineering and Silviculture Branch

Protecting Forest Soil, 1987. Silviculture Branch

Introduction to Silvicultural Systems: A Self-Study Workbook, 1998, Forest Practices Branch

Crown Publications Inc., Victoria

Forest Service Scaling Manual

Table of half volume cylinders and cubic decimetres, Forest Service Publication #546

Workers' Compensation Board of B.C.

Fallers' and Buckers' Handbook

Yarding and Loading Handbook

Forest Engineering and Research Institute of Canada (FERIC)

Use of the farm tractor in the forest:

Evaluation of the Agri-Winch: A Farm Tractor-Mounted Logging Winch. TN-41

4WD Articulated Tractors and Skidders for Woodlots. TN-87

Hydraulic Grapple Loaders for Farm Tractors. TN-88

Logging Winches for Farm Tractors. TN-90

Logging Trailers for Farm Tractors. TN-97

Evaluation of the 0-30 - Vimek Processor Attachment for Farm Tractors. TN-99

Small, inexpensive equipment for woodlot owners who do not have a farm tractor:

Evaluation of Wood Caddy and Goliath Mini-Skidlers. TN-86

Can All-Terrain Vehicles be Used for Forest Work?

Equipment for fuelwood and energy-chip production:

Evaluation of the Bruks Mobile Chipper. TR-91

High-Capacity Firewood Processing and Marketing. Handbook #76

Other FERIC

Compendium of Commercial Thinning Equipment and Operations in Western Canada, 1995

Handbook for Ground Skidding and Road Building in the Kootenay Area of B.C.

Planning for the B.C. Interior: The Total Chance Concept. Handbook No.4

Handbook For Logging With Farm Tractor-Mounted Winches. Handbook No.2

Purchasing a Used Skidder or Forwarder For Use in Small-Scale Operations. TN-260
1997

Winching Down Lodged Trees With a Helper Chainsaw Winch. Field Note 16

New Brunswick Department of Natural Resources

Forestry Extension Service, P.O. Box 6000, Fredericton, NB, E3B 5H1

Snowmobile Logging with a Homemade Bobsled

Harvesting Trees From Thinnings Using Small Winches. 1984. Forest Extension Branch

The National Board of Forestry

The Chainsaw Use and Maintenance, 1979., Sweden. Available through the N.B. Forest Extension Service

The Farm Tractor in the Forest, 1982. Sweden. English translation available through the N.B. Forest Extension Service

The Chain Saw for the Casual User, Forest Training Unit

Oregon State University Extension Service

Timber Harvesting Options, EC 858

Logging Woodland Properties, EC 1188

Felling and Bucking Techniques for Woodland Owners, EC 1124

Designated Skid Trail Minimize Soil Compaction, EC 1110

Hauling Logs From Woodland Properties, EC 1140

Increasing Values Through Bucking Practices: Manufacturing Logs, EC 1184

OPBRQ (Office des Producteurs de Bois de la Region de Quebec (in English))

Using an All-Terrain Vehicle to Produce Long-Length Logs 1995

Using a Farm Tractor to Produce Long-Length Logs 1995

Other Sources

Small Scale Forestry newsletter Dept. of Operational Efficiency, Swedish University of Agricultural Sciences. 5-770 73 Garpenberg, Sweden. US\$10. Published twice yearly (available in English)

Felling Manual and Limbing, Bucking and Bunching, 1991 Forskningsstiftelsen Skogsarbeten (Swedish equivalent to Workers Compensation Board)

Selling Standing Timber (contracts and agreements) Ontario Ministry of Natural Resources LRC 36

Equipment

Appropriate Small Scale Logging Equipment [www.rockisland.com~tom/tools.html]

“*The Forester: Tractor and Forwarding Trailer*”

[www.payeur.com/anglais/products.htm]

Stoldt, Michael V., *Talon Equipment (fabricators of small-scale equipment)*.

(604)291-1614

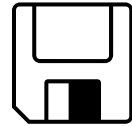

Forest Products Overview

Marketing

In this chapter...

From Woodland to the Marketplace	150
How to Identify Timber Products	155
Special Products From Your Woodland	158
Recommended References	164
.....	

From Woodland to the Marketplace

Woodland products range from traditional goods, like sawlogs and plywood peelers, to special products, such as orchard props, Christmas trees and fence posts, but also include non-timber products such as herbs, mushrooms, floral greenery and medicinal plants. Woodland products can also include services such as hiking and fishing, and values such as watershed protection and wildlife enhancement. In some cases, the major ‘products’ of a woodland are fresh air, privacy and the simple pleasures of a treed environment.

The products you choose to produce will be affected by your short- and long-term objectives for the property; the species mix, age and quality of your current forest, and the markets to whom you can sell. This chapter discusses how to select your product mix, identify markets, and design and draw up the conditions of sale.

Producing and selling the forest products from your woodland involves the following steps:

1. *Choosing your products*
 - consider your personal goals for your woodland
 - consider your financial and human resources limitations
 - check inventory for potential products based on species, age and condition of stands
 - identify those products that best serve your goals within given personal limitations.
2. *Research and identifying your markets*
 - identify potential markets (i.e., local, domestic, export)
 - assign product priorities based on such things as stability of market, highest return, largest market demand
 - confirm product specifications with buyer.
3. *Producing your products*
 - identify the products to be produced in each Management Area
 - establish appropriate management programs for the production of each product (e.g., pruning for peelers; thinning for sawlogs)
 - set harvesting priorities and logging methods for production of each.
4. *Selling what you produce*
 - choose the point of sale
 - select buyers
 - develop contractual agreements.

Choosing Your Products

Your choice of products will be influenced primarily by your personal goals, management objectives, the characteristics of your woodland, and what you have in your woodland inventory. If you have a mixed, uneven-aged stand, you will have the potential to harvest a variety of products. The following list of products will help you to start thinking of the types of goods you might produce from your current forest.

Timber Products											
Products	<i>Species Code</i>										
	Fd	Pl	Ps	Pw	Py	B	Cw	L	S	H	
peeler logs	✓	✓		✓		✓		✓	✓		
saw logs	✓	✓		✓	✓	✓	✓	✓	✓	✓	
pulp logs	✓	✓		✓	✓	✓	✓	✓	✓	✓	
large poles	✓	✓			✓		✓			✓	
boom sticks	✓					✓	✓		✓	✓	
<i>Special Products</i>											
building log	✓	✓		✓			✓	✓	✓		
car stakes		✓									
Christmas trees	✓	✓	✓	✓		✓			✓		
cribbing	✓										
fence post		✓					✓				
firewood	✓	✓	✓	✓	✓	✓	✓	✓	✓	✓	
grape stakes		✓									
hop poles, orchard props		✓									
mining timbers	✓	✓								✓	
pickets, palings							✓				
piling	✓							✓			
small poles	✓	✓			✓					✓	
shakes, shingles							✓	✓			
<i>Species Key</i>											
	Fd	Douglas-fir					B	balsam			
	Pl	lodgepole pine					Cw	western redcedar			
	Ps	scotch pine					L	larch			
	Pw	white pine					S	spruce			
	Py	yellow (ponderosa) pine					H	hemlock			

These products are obviously produced from different stages in the life of a forest stand and consequently have different rotation ages. Some are produced from thinnings, others from mature timber, and still others (such as Christmas trees) from plantations. You may wish to produce a mix of products that can provide you with a continual cash flow, including short rotation crops such as Christmas trees (6–9 years), honey (annual), and firewood (10–20 years, annual thereafter), along with the more traditional timber products of sawlogs and plywood peelers (40–80 years). You may also wish to consider the enhancement and development of aesthetic, recreational, wildlife, watershed and fisheries values as ongoing products of your woodland.

A good way to begin the process of product identification is to make two lists. The first of these will identify your personal goals for the woodland. The second will itemize the potential products from your woodland, based on the species mix, age, size and condition of the trees on the area. Your task will be to determine the best way that you can use your inventory to achieve your goals.

Part of the process of choosing your products will be to consider how the production of different products will affect your short- and long-term objectives. Don't be surprised to

find that some of your objectives may conflict. And don't give up when they do—there may be alternative ways of achieving them.

For instance, the clearing of a two hectare stand of Douglas-fir/hemlock sawlogs may be the simplest and quickest way to obtain the short-term cash for your daughter's forestry tuition, but clearcutting the area will unfavourably alter the trail system and environment that the whole family currently enjoys for mountain biking and cross-country skiing. As an alternative, there are eight large peeler-quality Douglas-fir trees bordering the property that could pay for

half the tuition, and additional revenue could be generated by producing firewood from the deciduous/conifer mixed stands on the woodland. Both have benefits, and both have costs to the family—but in many cases, small woodland management is a family business. You must work out the alternatives that best suit you and your family.

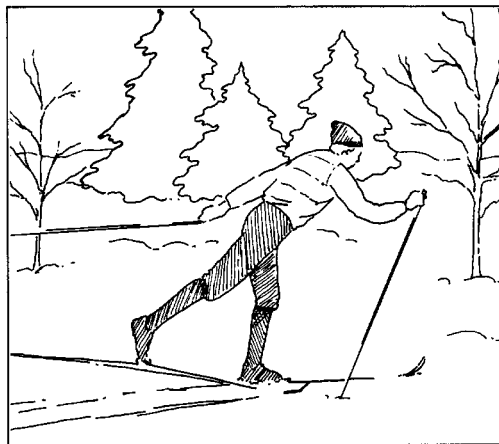
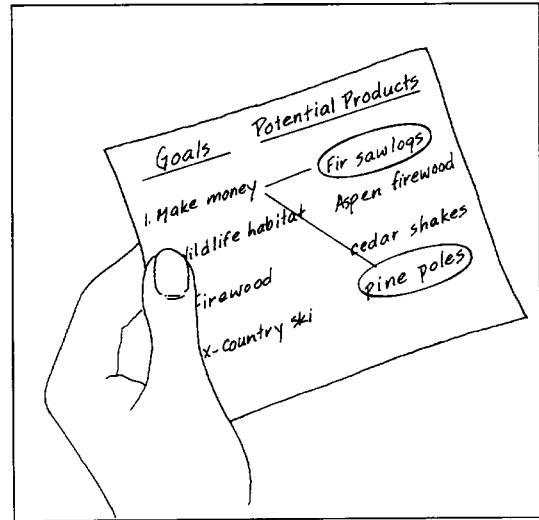

It is important to remember that alternatives usually exist, and it is worthwhile to spend time considering them carefully before you confirm your Forest Management Plan. The ways you use and feel about your forest are as important as other inventory information in planning the development of your woodland. For instance, if aesthetically you value the dominant fir in your stand, then search out market opportunities for the co-dominant and other species. Don't compromise your long-term values until you have evaluated alternative ways of solving your short-term cash flow problems.

Identifying Your Markets

Once you have selected the products you are interested in producing from your woodland, the next step is to identify markets for them. For the major timber products, your potential buyers will be readily identifiable—in most cases, the local mills. For special products, such as poles, or Christmas trees, you may have to do a little advertising to interest buyers. You may want to consider getting a log broker to handle the marketing and selling of your forest products, especially if you feel you have valuable products of interest to customers outside your local area.

For local markets, try to obtain a number of bids for your products. Advertise in your local newspaper. Invite potential buyers out to look at your standing timber, and discuss what they are looking for. By cutting your products to the buyer's specifications you will obtain the best price for your timber. You can greatly increase the value of your log products by bucking out defects and trimming the ends square (see *Bucking* in the chapter

“Harvesting the Trees”). Find out how much you can get for different products so you can compare their values, costs of production, and the impacts of their production on your woodland.

Market conditions will affect the price you get for your product. Since production costs remain fairly constant, your ability to take advantage of high points in the market cycle will make a large difference in the profit you receive for your goods. Private owners and Indian bands in particular, have considerable flexibility in terms of when and how much they cut. It is worth your while to follow the ups and downs of the markets in which you are selling, and be ready to act when markets are paying top prices. To do this, you must have your roads in place and your production process clearly outlined. Define your own role in production as early as possible, and identify potential sub-contractors for felling, skidding or hauling.

The Ministry of Forests produces a monthly statement of average log prices, available free of charge, on request or from their website (www.for.gov.bc.ca/revenue/timberp/). Lumber prices can be followed in the trade publications, or obtained from your local mill manager.

Finally, a note on pricing. Market conditions will largely determine selling prices, so look for opportunities to increase the value of your products (e.g., forest certification, log exports, specialty products). A process such as forest certification or a change in production may create a higher value product that appeals to different markets. Adding value can be as simple as bucking or as complex as handcrafting furniture.

Producing Your Products

When you have confirmed your mix of products, their specifications, potential buyers, and contractors, the production process can begin. You will need to develop plans for the management and production of specific products in different areas of your woodland. As you plan the harvest of current products, you must also keep in mind the kind of stand and products you wish to create in the future. The silviculture system you choose for the management, harvesting and reforestation of each *management area* will reflect your long-term product objectives.

Your Forest Management Plan should identify the products you wish to produce from each *management area* along with the related stand management activities (such as pruning or thinning) required for the production of each product. It also should specify the method of extraction and handling and form in which the product is to be produced, such as log length. These specifications are important to make sure that you maximize the value of each stand and tree.

As with most woodland operations there are a number of ways to ‘skin the cat.’ You can do everything yourself or contract it all out. It is often to your advantage to sell your own timber, to make sure that you obtain the highest value for every piece cut and receive payment for every log harvested. Whichever route you take, it is worth your while to remain in control of when and how work is done. The amount of potential damage caused by sloppy harvesting and skidding can cost you greatly in terms of the value of the products you recover from the current crop, the health of the remaining stand, and the necessary post-production cleanup and site rehabilitation.

Selling What You Produce

You have options on how to sell your products and who to sell them to. Your choice of market will likely consider which option gives you the most control over what happens, and which buyer gives you the best return on your wood. It will also be influenced by the conditions under which you are selling. For instance, you may choose to sell your trees on the stump in cases where you are confident of the accuracy of your inventory, need money quickly, have no capital to invest in harvesting, or are worried about risks to your stand (perhaps from fire or pests). You might choose to sell at the landing if you are unsure of the reliability of your inventory data, and have no means of hauling logs. Or you may choose to sell at the mill in cases where you are able to carry out all logging phases and wish to capture the profit margin at each phase.

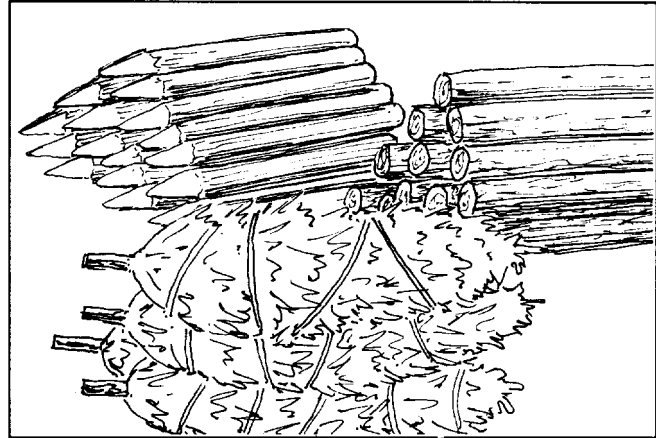

Point of Sale	Options for Who to Sell to
<ul style="list-style-type: none"> • on the stump, based on the inventory 	<ul style="list-style-type: none"> • contractor or log broker
<ul style="list-style-type: none"> • at the landing or dump, based on the scale 	<ul style="list-style-type: none"> • log buyer or mill
<ul style="list-style-type: none"> • at the mill, based on the scale 	<ul style="list-style-type: none"> • mill

Payment is usually based on the material hauled away, at an agreed price per unit of material: cubic metres for logs, cords for firewood, or by the piece with products such as Christmas trees. The unit value is agreed on at the outset, but payment is based on the scaled volume of material at the landing or the mill gate.

You have the option of producing the products yourself; contracting the logging and doing the selling yourself; or selling selected products to the buyer while the trees are still standing and letting the buyer extract them. In both the latter cases it is important for you to negotiate and include in the contract additional terms relating to the logging and site cleanup procedures. Letting the buyer extract your timber can result in high-grading of an area unless they are closely controlled.

It is extremely important for you to keep track of how much timber is removed and delivered. Scaling is commonly carried out at the dryland sort or mill, so be sure to ask for all mill receipts to compare the volume removed against the merchantable volumes indicated in the timber cruise. It is also a good idea to request spot scaling checks to make sure that your material is being sorted and sold according to its highest value.

To optimize the yield of your target products:

1. Set harvesting priorities and decide on logging methods for each product. Consider accumulating as much volume as possible to include in your sales package. Generally, larger volume packages will command a higher price. Look into pooling your products with other woodland owners.
2. Time the sale to suit your objectives and catch peak prices. Monitor the market and keep up to date with market information.
3. Conduct a timber cruise to get an estimate of your timber volume. A timber cruise will provide an estimate of volume of timber and grades based on sampled plots within standing timber. Prospective buyers can use the information to develop offers, reducing the risk for both buyer and seller.
4. Arrange buyer(s) and develop contractual agreements. Most mills and log buyers have standard purchase agreements or contracts. To protect your interests, use a written contract and make sure it accurately reflects the agreed terms, including:
 - point of sale
 - contract term
 - scaling
 - sales price
 - payment terms
 - holdbacks
 - log quality bonus/penalty
 - contract termination clauses

How to Identify Timber Products

Peeler Logs

- “Peelers” are generally purchased by companies that manufacture plywood products. They are turned on a rotary lathe to produce veneer.
- Douglas-fir, pine, larch, spruce and balsam
- Fine grain logs (at least six rings per inch)
- 17' 8" or more in length and 9" top size or larger where at least 80% or more of the gross scale will cut out on a rotary lathe into veneer.
- More detail regarding log quality requirements can be found in the Coastal Log-Grading Manual.

Large Saw Logs

- Douglas-fir, pine, redcedar, hemlock, larch, spruce and balsam
- Same general bucking/quality requirements as all saw logs—12" top minimum
- Preferred lengths—bucking specifications will vary by mill but typical interior lengths are: 53' 6" and 49' 6"; minimum length 12' 6"; and 2' increments to 20' 6", 23' to 41' in 2' increments, 43' 6" to 53' 6" in 2' increments.

Small Saw Logs

- Same general bucking, quality and length specs as above (not a pole), maximum top 12".

Custom Cut Logs

- Generally purchased by specialty cutting sawmills that target higher value lumber markets.
- Larger, higher grade redcedar, cypress, spruce, hemlock, balsam and Douglas-fir
- Generally log grades “B,” “C,” “D” and “F” as per the coastal letter grade summary for these species.

Spruce/Hemlock/Fir High Grade

- This is a sort used by some log sort yards, such as one operated by the Revelstoke Community Forest Corporation
- Clear surface or pin knots on two quadrants, minimal spiral grain and minimum top size 14"
- Minimum length 12' 6", preferred lengths 53' 6", 40' 6", 27', 13' 6".

Pulp Logs

- Generally, lower grade logs, sometimes with a small diameter, or with a high number of knots and twist, must contain more than 50% sound wood and be more than 3 m in length, and not suitable for lumber or other products.
- The forest industry will buy hemlock, amabilis fir, Douglas-fir, some sub-alpine fir and some redcedar pulp.
- Pine pulp is not generally marketable on the coast. Sub-alpine fir and redcedar pulp are also a tough sell. Sales prices will be discounted if you are able to find a willing buyer. Delivery logistics, total sales volume, species mix, top size and scaling methodology may affect sales on the coast.
- Pulp logs are usually defined as logs not suitable for the manufacture of lumber: generally coastal log grades U, X and Y, and interior log grades 4, 5 and 6.
- Generally you should try to sell your pulp logs along with better grade logs so you are not stuck with them.

Boom Sticks

- Boom sticks are used for containing loose or bundled logs in the water for log transportation or storage.
- Spruce, hemlock, balsam, redcedar or Douglas-fir.
- Usually larger logs, (can be rough timber with large knots and/or twist which make them unsuitable for the recovery of higher value lumber).
- Must be straight and sound, between 55' and 70' in length (preferably 60' or longer).
- 14" minimum diameter and 34" maximum diameter.

House Logs

- Douglas-fir, pine, redcedar, larch, and spruce
- Sound, straight (no spiral grain), low taper, no sweep or excessive butt flare
- Typically, minimum top diameter of 10", green timber (easier to cut and work)
- Most builders prefer winter cut logs for their lower moisture content and sap production.

Fence Rails

- Typically, small pine or Douglas-fir, with butts less than 7"
- Straight and sound, low taper preferred.

Shake and Shingle Logs

- Used for roofing and siding materials
- Shake and shingle grade logs will have fewer but possibly larger knots than saw logs spaced to permit the production of shingle blocks
- Shake and shingle logs are generally unsuitable for the manufacture of lumber because of the nature of the knots, irregular shape, excessive butt or heart rot, bark seams, open checks, rotten knots, shatter or combinations of the above.

Cedar Shake Slabs

- Minimum length 12' 6", minimum size 6" × 6" (larger is more valuable for lumber recovery)
- Straight grain, only a few small knots, no severe cracks or splits, suitable for lumber production
- Smaller slabs, 4" or less, may be marketed to fence post and rail buyers.

Cedar Shake Blocks

- Minimum 24" lengths, suitable for shake production
- Shingle production can be from 18" blocks.

Spruce Tonewood (guitar and violin tops)

- Typically 20" top minimum: depending on clear wood content could be as low as 14" top
- High-grade log specifications, clear wood—no knots, minimum six rings per inch— even grain, no mineral stain.

Bridge/Lowbed Decking

- Planks are typically 2" to 4" thick by 6" to 10" wide, depending on intended traffic (nominal sizes). Contact local mills to inquire about demand and prices.

Beams and Stringers/Mining Timbers

- Thickness of 5" and up, with width more than 2" greater than thickness
- Length of 6' to 16' and longer
- Species are typically hemlock, pine, spruce and Douglas-fir; with five grades of beams and stringers.

Dunnage

- Buyer specifies minimum sizes. Generally, minimum 2" thick and 3" wide and used for separating lifts of lumber or other forklift-stacked merchandise.

Railway Ties

- There is one grade of sawn railway ties, but three categories based on face sizes
- Must be four sawn faces with opposite faces parallel
- Buyer will specify species and size restrictions Typically pine, larch and Douglas-fir; cross sections 6" by 8" (#2 and #3) to 7" by 9" (#1); lengths generally 8', 8' 6", or 9'.

Railcar Framing and Decking

- All conifer species are acceptable
- Rough or surfaced; 1 1/2" to 4" thick; 4" to 12" wide; lengths specified by buyer.

Barn Flooring

- Typically 1" to 1 1/4" thickness to 4 3/8" to 5 3/8" width ranges actual size
- Lengths specified by buyer.

Fence Posts and Fence Rails

- Potential outlet for interior grade 6 logs, coastal grade Y logs and redcedar slabs of less than 4"
- Buyer will specify dimensions and lengths.

Landscape Ties

- Minimum two sides sawn
- Dimensions and lengths specified by buyer
- Pine, spruce, hemlock and Douglas-fir.

Special Products From Your Woodland

Christmas Trees

Christmas trees are finding increasing favour as a small woodland crop that an operator can manage almost entirely on their own. They have a short rotation—less than 10 years—and require a minimum cash investment once the site has been prepared and the initial stock has been purchased. Be forewarned, however, that profitable Christmas tree production involves a lot of work, and there is a healthy competition from domestic and U.S. growers, as well as producers of *artificial* trees.

In British Columbia, Douglas-fir is the species most commonly grown for Christmas tree stock, though pine and amabilis fir are also produced by some growers for specialty markets. When buying Christmas tree stock, as with most seedlings, try to obtain stock grown from seed from your local nursery, or in a similar area within the species range. Local stock is important because some of the traits that make it successful in that environment are passed on, genetically. Be sure to discuss species and strain (a subgroup within a species) alternatives with your nursery manager or local forester.

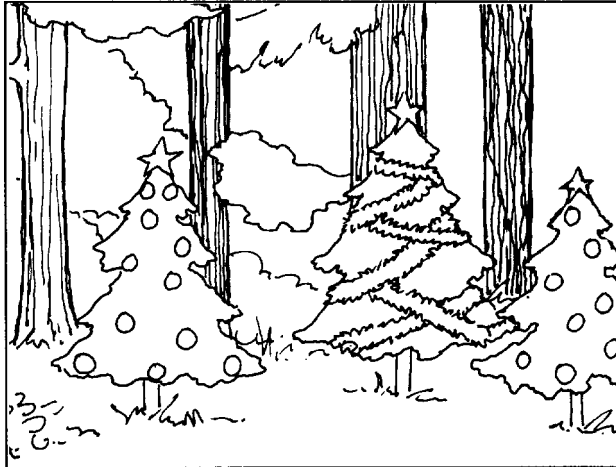

Douglas-fir stock from Duncan, on Vancouver Island, is an acknowledged coastal favourite with growers because it is a late bud bursting strain. Since many of the pests that plague Christmas trees do their damage at or around the time that new foliage appears in the spring, strains of stock that ‘flush’ (burst their buds) late in the season have distinct advantages. The tree’s new growth emerges after the pest’s eggs have hatched, thus missing the period in which the new larvae

are hungriest. Late bud burst also protects the seedlings from foliage damage associated with early frosts.

In Christmas tree production the quality of the stock you choose is extremely important. Since the rotation period is short, it is essential that the seedlings are strong and healthy and able to establish themselves in the field quickly. Two or three year old stock is recommended; the higher initial cost of older stock is often outweighed by the benefits of a shorter rotation period. Some growers find it worthwhile to grow their own seedlings.

Christmas tree culture is an intensive practice, requiring annual pruning (shearing) to shape the trees and an aggressive protection program. As a cosmetic crop, Christmas trees are especially vulnerable to damage. Insect damage causes discolouration, defoliation, or loss of vigour, and toothed pests such as mice, rabbits and deer can severely damage stem form and branching patterns. Damage by domestic animals can be controlled by fencing, and the favoured approach to controlling deer damage is to control grass in the Christmas tree plantation. Chemical repellents are sometimes applied directly to the trees, but require constant re-application.

Douglas-fir, the major Christmas tree species grown in British Columbia, is prone to a number of **needle diseases**. Foremost is the *Douglas-fir needle midge*, identified by small, brown spots on the underside of the needles. *Swiss needle cast* is another defoliator of Douglas-fir, and appears in the spring as small, black spots on the underside of needles.

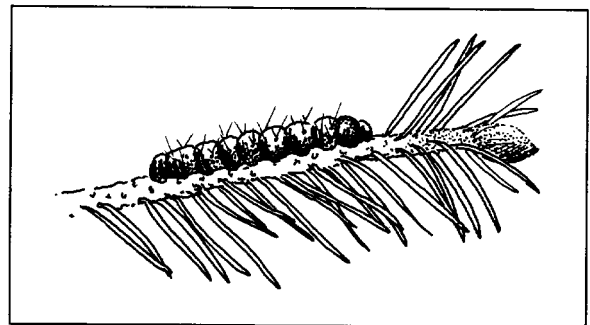

Rhabdochline, a fungal disease, is recognized by its red-brown spots on previous year’s needles. *Douglas-fir tussock moth*, whose larvae attack new foliage, damages the form and growth of the tree. As with other tree crops, the maintenance of healthy plantations combined with early identification and prompt removal of infected trees, is often the most effective protection strategy.

Fire and theft are also potential threats to profitable Christmas tree production. Fire guards and fire fighting equipment should be kept in all plantation areas. Plantations should not be in sight of main, public access roads and should be checked regularly, especially prior to the Christmas season. Security measures may be necessary.

Christmas trees can be marketed either on a wholesale or retail basis. Large and remote Christmas tree operations generally sell their trees wholesale. Contracts are signed as early as July or August, and should definitely be completed by the beginning of October. Trees are harvested in late November, and wrapped in twine or mesh bags to align and flatten branches for compact storage and minimum damage during shipping.

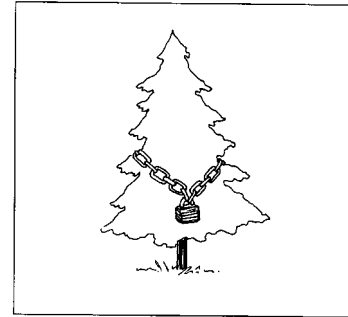

Where Christmas tree sales are made on a unit basis, the trees to be harvested should be clearly marked. Wholesale contracts often provide for 50% payment on signing of the contract and the remainder once all trees have been received by the buyer.

Smaller-scale growers, close to markets, have the advantage of retailing their products for higher prices. Rental of open-air lots should be settled early in the fall, and trees should be displayed by grade. For growers wishing to decrease the capital involved in Christmas tree harvesting and transportation, and reduce the risk of having cut trees still unsold on Christmas day, there is a 'choose and cut' option where people come to the plantation to select and cut their Christmas tree. The success of this marketing alternative depends on widespread, advance advertising since the selling period is so short. An added benefit of this system is that the trees not selected for harvest in one year can be grown and tended for potential sale in the next season. Growers choosing this option often plant a small number of special species such as true fir (grand, noble or sub-alpine) and Scotch pine.

Along with Christmas trees, there is often a smaller Christmas market for specialty items such as redcedar and holly, wreaths, pine cones and balsam boughs (for aroma). The entrepreneur may also have home-built Christmas tree stands for sale.

Christmas Tree Guidelines:

- choose quality stock appropriate to your site
- plant stock as soon as possible
- plant carefully
- protect your investment from pests

For a more detailed discussion on the tending and shearing of Christmas trees, consult the *Christmas Tree Culture* brochure produced by the Ministry of Forests.

Firewood

Where markets exist, firewood is an excellent dual-benefit woodland crop. It makes use of deciduous and malformed or inferior species that are removed to improve the quality and spacing of your stand, and produces revenue that helps pay for the stand improvement activity. When selecting trees for firewood, consider those that are:

- crooked, leaning, windthrown or badly damaged
- diseased, or dying (pest or other damage)
- suppressed trees or suppressing 'wolf' trees
- weed trees or inferior species
- don't overlook cull logs and top ends of trees.

Note: In your cleanup, remember the needs of those forest critters (e.g., woodpeckers, owls and other cavity nesters, raccoons, rabbits) that rely on dead or dying trees and logs for breeding, shelter and food (coarse woody debris and wildlife trees).

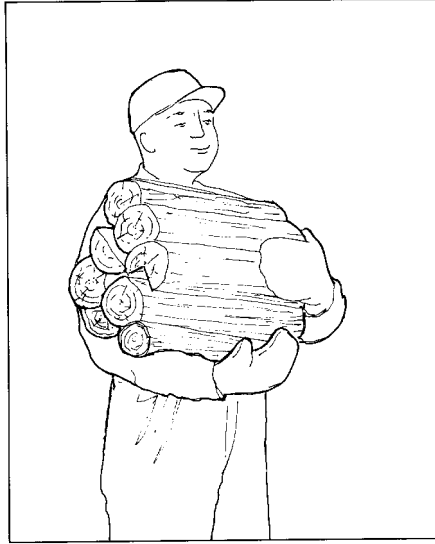

Producing firewood is an activity that the woodland operator can carry out on his own, or as a family business, with a minimum of heavy equipment. It requires skills in felling and bucking, some basic equipment for yarding, a strong back and a love of the outdoors. Be ready to work for your wood—an Ontario study estimated the production time for a cord of sugar maple firewood, from felling to splitting to woodshed to stove, at 9.5 hours!!

Two pieces of information are key to the production of firewood—different species have different heating capabilities, and dry, heavier wood produces better heating per unit volume than wetter or lighter wood. The hardwood, deciduous species are therefore better for firewood than the softwood conifers. Other factors, such as the relative ease of lighting and splitting, as well as the amount of smoke and spark produced, are also important marketing considerations when selecting your firewood species.

Following is a comparison of major hardwood and softwood species for each of these factors and an overall rating of their value as firewood:

Species	Firewood Performance					
	Heat/unit	Ignition	Smoking	Sparks	Spitting	Rating
apple, dogwood	med.–high	difficult	little	few	medium	excellent
alder, cherry	medium	difficult	little	few	easy	good
aspen, cottonwood	low	easy	medium	mediurn	easy	best kindling
maple, oak	high–med.	medium	little	few	med.–hard	excellent
cedar	med.–low	easy	medium	many	easy	best kindling
spruce, pine, balsam	low–med.	medium	medium	medium	easy	best kindling
larch, Douglas-fir	med.–high	medium	little	mediurn	easy–med.	good
hemlock, birch	med.–low	easy	little	many	easy–med.	medium

Firewood is sold in log lengths (1.2 metres and 2.4 metres) to firewood processors as unsplit firewood logs (usually less than 30 cm diameter), or as split firewood for fireplaces and woodstoves. Hardwoods are generally preferred by fireplace customers because they burn longer and throw fewer sparks. Dense, seasoned hardwoods provide the best heat value per unit of wood.

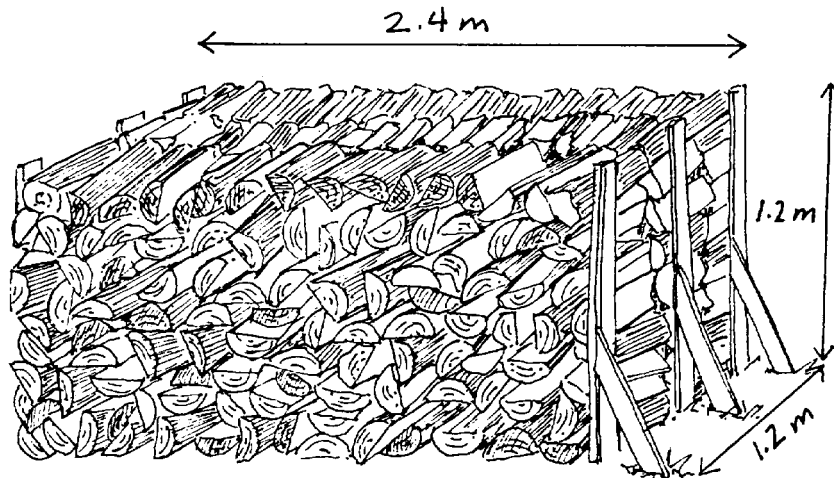

Firewood is still sold mainly in cord portions, either as a standard cord of 1.2 m × 1.2 m × 2.4 m (based on the old 4' × 4' × 8' imperial measure); a face cord, where the piece length is specified, such as 0.5 m x 1.2 m × 2.4 m; or by weight.

Tips For Reducing Drying Time:

- leave the leaves on felled trees for the first month after felling
- leave felled trees to 'hang to dry' (i.e., supported by brush or stumps to keep them above the moist forest floor) in the woods for a year
- place bucked sections on 'cribbing' to keep above ground and facilitate air flows
- pack woodpiles loosely and in separate piles
- keep under shelter (a roof, not a plastic or tarp) and well-aired

Family Forestry

In addition to all the things you do to improve your woodland and produce items for sale, there are many opportunities for first-hand learning and plain old fun. These 'woodland products' should not be overlooked or undervalued—many of you will be growing a crop of kids along with your trees.

Families are making many of their Christmas gifts from woodland goods—cone ornaments and wreaths, pressed flowers, potpourri sachets, terrariums and jewelry castings. Fish ponds are a natural addition to a woodland, both for personal and commercial consumption. Trout are being successfully pond-reared on some woodlands. Woodlands are sources of other food products as well, including: nuts (such as hazelnuts), berries, mushrooms, edible roots, herbs and other plants. Recognizing



and collecting these materials can be very satisfying (in more ways than one!). A number of source books for identifying and even preparing forest delicacies are available; some are listed at the end of the chapter.

A woodland nursery can be an enjoyable and rewarding project for all ages and interests. The most nimble members in the family can pick the cones and oversee the extraction of seed; the scientists can devise experiments to test seedling response to various soils or fertilizers; and the economist in the family can calculate the costs of renewing the crop that the entrepreneurs are planning to log, while the wildlife biologist devises a cutting plan to enhance deer habitat. Something for everyone. And there's always the woodpile for working out those day-to-day frustrations and getting something in return.

Some retail stores buy forest products such as seeds, cuttings or small plants from species such as wild rose, salal, sword and maidenhair ferns, trillium, and Oregon grape. Check with your local nursery or plant store to see what they might be interested in. If you find a reasonable market for a product or plant, consider adding it to your woodland nursery for controlled production.

For the woodworking enthusiast, the forest is a regular storehouse. There are burls to carve (maple, birch, redcedar, pine): materials to turn on the lathe (yew, arbutus, birch, yellow-cedar); and a variety of special wood grains to explore (yew, arbutus, maple, birch, alder, white pine, yellow-cedar). These specialty woods are available in some hardwood and woodworking shops, but once you know what to look for, search them out on your woodland.

With the rich history of aboriginal use of the province's forest lands, your woodland offers an excellent study site on which to explore and learn how trees and other plants have been used as sources of traditional food, clothing, tools, medicines, shelter, transportation and social and religious artifacts.

There are many product opportunities on small-scale woodlands in addition to log production. Each property is different, and each is shaped by the desires (and talents) of its operators. Using simple technologies, your creative energies, problem-solving skills, and elbow grease, you can shape your property to a variety of ends.

Why Wood Is Good

Wood is a delightful and fascinating material. It has life, smell, texture and personality. Its advantages as a building material relate largely to its cellular structure and the fact that it is made up of hollow tube like cells or fibres. Here are some of the reasons why 'Wood is Good':

- it is relatively light, strong for its weight, and easily transported
- it is easily fastened by nails, screws or glue
- it is a poor conductor of heat, electricity and sound
- it is porous, and holds paint or stain well
- it floats, unless saturated
- it resists rusts, acid and salt water
- where defects exist, they are usually on the surface and can be readily detected
- it absorbs shock and vibration
- it expands little with changes in temperature
- it is pleasing to the eye, touch, nose
- it is easily worked and grows more beautiful with age
- it is multi-purpose: as trees, timber, and forest products
- it is renewable.

Recommended References

Small Woodlands Program of BC

A comprehensive 'Small Woodlands Library' is available on the web [www.swp.bc.ca]

BC Ministry of Forests

Christmas Tree Culture. 1988

Christmas Tree Farming. Publication B

BC Provincial Museum, Victoria

Guide to Common Edible Plants of British Columbia. Handbook 20

Guide to Common Mushrooms of British Columbia. Handbook 24

Food Plants of British Columbia Indians – Part I, Coastal Peoples. Handbook 34

Food Plants of British Columbia Indians – Part II, Interior Peoples. Handbook 36

Canadian Forest Service

Pacific Forestry Centre

506 West Burnside Road

Victoria, BC, V8Z 1M5, tel.: 250-363-0600, fax: 250-363-0775

[www.pfc.cfs.nrcan.gc.ca]

An Introduction to Christmas Tree Growing in Canada. 1982. Publication 1330

Common Insects and Diseases of Balsam Fir Christmas Trees. 1981. Publication 4328

Forest Mushrooms. Brochure

Publications on many forestry-related topics are available on request from the on-line bookstore at [<http://bookstore.cfs.nrcan.gc.ca>]

National Museum of Canada, Ottawa

Wild Coffee and Tea Substitutes of Canada. 1978

Edible Wild Fruits and Nuts of Canada. 1979

Edible Wild Greens of Canada. 1980

FERIC

Handbook of High-Capacity Production and Marketing of Fuelwood. Handbook 6

BC Ministry of Agriculture, Food and Fisheries, *The Recognition and Life History of the Major Insects and Mite Pests of Ornamental Shrubs and Shade Trees of B.C.*

Small Woodlands Program of BC

Small Woodlands Business Planning and Marketing Guidebook. 2002. Smithers

A Guide to Agroforestry in BC. 2001. Smithers

ENFOR, 1981. *The Feasibility of a Home Heating Fuelwood Industry on Southern Vancouver Island*. BC- X-224

De Geus, N. 1995. *Botanical Forest Products in B.C.: An Overview*. MoF Publication

Sterling Wood Group Inc, 1991. *How to Manage Your Woodlot for Firewood Production and Sales*.

Schniutz, E.M. and L.B. Hamilton, 1979. *Plants That Poison*. Northland Press, Arizona

Springthorpe, G.D and N.G. Myhill, 1985. *Wildlife Rangers Handbook*. Forestry Commission, Edinburgh, Scotland

Hoadley, R.B.J., 1980. *Understanding Wood*. The Taunton Press, Connecticut

Gunther, Erna, *Ethnobotany of Western Washington. The Knowledge and Use of Indigenous Plants by Native Americans*. 1981. University of Washington

MacKinnon A. and J. Pojar, 1994. *Plants of Coastal British Columbia*. Edmonton

Coupé R., A. MacKinnon and J. Pojar, 1992. *Plants of Northern British Columbia*. Edmonton

Coupé, R., D. Lloyd and R. Parish, 1996, *Plants of Southern Interior British Columbia*. Edmonton

Lincoff, G. 1991, *Field Guide to North American Mushrooms*, The Audubon Society. New York

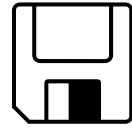

Non-timber Forest Products

Marketing

In this chapter...

What are NTFPs?	166
The Business Potential of NTFPs	166
Some Edible Herbs and Wild Vegetables	168
Wild Mushrooms	169
Wild Berries and Fruits	169
Medicinal and Pharmaceutical Plants	170
Floral Greenery	171
Landscape Products	172
Recommended References	175

.....

What are NTFPs?

In recent decades, there has been a growing interest in a range of alternative botanical products from forest-lands broadly classed as non-timber forest products (NTFPs). These products have a wide range of uses and an equally demanding and evolving marketplace. While NTFPs may seem new they have been around as long as people have lived in and around forests. In fact NTFPs can be thought of as the original forest products, since people foraged for and collected NTFPs for food, and medicine, tools, and clothing long before they had the tools and technology to make use of the timber that stood in ancient forests.

NTFPs are those products that your woodland produces that are not trees, logs or traditional wood products. NTFPs arise from the diversity of plants that simply exist in a woodland or can be grown and cultivated within the woodland environment.

There is no clear definition of NTFPs, in fact, there are many. For the purposes of this guide they are grouped as follows:

- edible products (herbs, mushrooms and berries)
- medicinal products
- floral greenery
- craft products.

The potential and capability of your woodland to produce NTFPs should be carefully evaluated and the options fully explored during your forest management planning process.

The Business Potential of NTFPs

Awareness of the business potential of non-timber forest products has increased in recent years. Due to its diverse forest types and associated biodiversity, British Columbia is widely recognized as a supplier of wild edible mushrooms, edible plant products and berries, floral and greenery products, and medicinal products.

There are many good reasons to explore the non-timber forest products potential of your woodland:

1. NTFPs can be profitable and can supplement your timber revenues.
2. Learning about NTFPs can help you develop knowledge about the potential of your woodland. Many of the species are site indicators of moisture, soil and micro-climatic conditions. Species with development potential should be included in your forest inventory. [Refer to *A Guide to Agroforestry in BC* for a discussion of site assessment and instructions on completing a NTFP inventory.]
3. NTFPs present opportunities to develop value-added products through activities such as crafts. They may also meet personal goals such as keeping bees as a hobby or exploring the potential of edible plants.

If you are producing NTFPs on your woodland, this activity should be reflected in both your Forest Management and Business Plans. It is important to ensure that these resources are managed sustainably.

Marketing NTFPs

The process of marketing NTFPs will differ from that of timber products because of the unique qualities of NTFPs:

Production cycle – The products generally have a short production cycle relative to timber products. Learn the production cycle of the crop. This will allow you to plan where, when, how and how much to harvest so that the volume can be sustainably harvested.

Perishability – Many of the products are perishable. The distribution and marketing systems must be designed to maintain quality from the woodland to the end user. This may require processing, handling and storage facilities.

Handling and distribution – Improper handling can significantly reduce quality and cause losses. Ensure that those who are harvesting and distributing the product know how to handle it properly. Estimate volumes (yields) in advance. Knowing the volume will help you arrange for transportation, storage and processing. Distribution of small volumes can be very costly on a per unit basis. Map out your distribution process and set up a system that will get the product to market efficiently.

Market characteristics – Markets may be hard to find and delivery to these markets may be difficult and expensive, especially in the case of fresh produce. NTFPs can be sold through a transient broker, on site, at farmers' markets or via the internet.

Price variation – There is usually substantial price variation, and unlike selling timber products, when marketing NTFPs there is limited opportunity to wait for better prices.

All of these factors point to the need for a well-developed marketing plan.

Pricing, Promotion and Selling

Historically, most NTFPs were sold on a cash basis with no paper trail. However, as markets evolve, established buyers, distributors and retailers will require records of their purchases. Keeping accurate accounts is a legal requirement of operating a business, and these records will help you to monitor and manage your business.

There is no formal permitting system for harvesting NTFPs on private land in BC. However, you should have written contracts with harvesters using your land. The contract should describe the conditions of harvesting—allowable times, allowable species, prohibition against other activities, and revenue sharing. It should also include conditions that protect you from liability.

Buyers and sellers are the best and almost the only source of price information for NTFPs in BC. In other words, prices depend almost entirely on the current market conditions. No publication, association or government agency collects and issues timely information on NTFP prices in BC.

[A list of NTFP buyers can be found in the SWP Business Planning and Marketing Guide.]

Pricing value-added NTFPs may require collecting and comparing information from several sources. To establish your prices, talk to buyers, check competitor's prices, check the price of substitute products, consider your cost of production, and test the market with your product. Some American companies publish prices for NTFPs on their web sites, and international prices for some processed medicinal and herb products are available in certain industry publications.

There is more print information on prices in Washington State because of the permit systems for harvesting NTFPs and the larger scale of its NTFP industry. Ranger districts, such as the Randle Ranger District that manages Gifford Pinchot National Forest, can provide price information. The Washington State prices are indicative of overall price trends for these products because their markets are international (rather than local).

Some Words of Caution

If you are interested in developing NTFPs as a source of revenue from your woodland, you should be aware of the following issues:

Safety – Any product collected for human consumption must be carefully identified. Not all NTFPs identified in popular literature as edible are safe. Some edible products can also be misidentified and confused with noxious or even poisonous species. Study products carefully.

Sustainable harvesting – Like forest products, NTFPs should be harvested in a sustainable fashion. You should develop a management plan which includes longer term objectives.

Rare or threatened species – Some NTFP identified in the literature should not be harvested from the wild in British Columbia because they are rare or threatened here. If you are interested in the commercial possibilities of these species, consider growing them.

Some Edible Herbs and Wild Vegetables

Common name	Plant part used	Product/use
Bedstraw	Leaves	Salad greens
Biscuit root	Root	Starch root stock used as flour substitute in allergenic diets
Chickweed	Leaves	Salad greens
Chicory	Root	Rootstock used to season foods
Ostrich fern Fiddleheads	Young fronds (the Fiddlehead)	Used as vegetable
Nodding onion	Bulb	Seasoning
Salmonberry	Stem	Used as vegetable
Skunk cabbage	Root	Used as vegetable
Stinging nettle	Leaves	Used as vegetable

Primary Distribution

Specialty retail outlets and high-end restaurants may buy NTFPs, but the seller must be prepared to meet their delivery demands and standards of quality and food safety. The producer should do thorough research to determine the volumes that can be moved through these markets.

Wild Mushrooms

The main wild mushroom products harvested in BC are:

- Pine mushroom – by far the most significant with harvests in excess of 250 tonnes per year
- Chanterelles
- Boletes
- Morels.

Shiitake mushrooms are also produced in BC. They are commonly cultivated either under cover or in woodlands on birch and alder logs.

Primary Distribution

Wild mushrooms are sold fresh as raw product to buyers located near picking areas. Wild mushroom buying systems in BC are organized around pine mushrooms. Buyers usually represent companies that ship offshore. The buyers establish temporary buying stations near picking areas. Buyers are the best sources of mushroom price information. Try to talk to a few buyers to ensure that you understand the price trend. Mushrooms, for the fresh market, must be sold quickly so it is best to know the process, buyers and locations in advance.

Prices are also posted at <http://www.vanisl.com/mushcash.html>.

Wild Berries and Fruits

The following table lists some of the wild berries and fruits produced in BC and their end uses.

Common name	End use
Blackberry	Jam, wine, fresh
Evergreen huckleberry	Jam, baking, dried fruit, fresh
Oregon-grape	Jelly
Oval-leafed blueberry	Wine, jam, fresh
Red flowering currant	Baking, dried fruit, jelly, fresh
Red huckleberry	Jam, baking, fresh
Red raspberry	Jelly, jam, wine
Salal	Baking, dried fruit, jelly
Saskatoon berry	Baking, wine, fresh
Velvet-leafed blueberry	Wine, jam, fresh
Western teaberry	Herbal teas; seasoning
Wild rose	Herbal teas, jelly
Wild strawberry	Jelly, wine

Primary Distribution

Wild berries and fruits are sold direct to consumer either raw or processed. The volumes of fresh, wild berries available are generally quite small so it is difficult to gather enough product to satisfy any major markets.

The three main distribution channels are:

- natural food wholesalers
- direct to retailers and high-end restaurants
- direct to consumers through road side stands or farmers' markets—especially for fresh berries.

Medicinal and Pharmaceutical Plants

The following table shows some of the current products found in BC's woodlands.

Common Name	Plant part used	Product/use
St. John's wort	Flowering tops	Anti-depressant
Oregon grape	Root	Laxative; antiseptic
Devil's club	Root	Astringent
Horsetail	Sterile shoots	Diuretic; astringent
Rocky Mountain juniper	Berries	Diuretic; stimulant
Sitka mountain-ash	Berries	Mild diarrhea cure
Skunk cabbage	Roots	Mild sedative
Willow	Bark	Aches and pains, tonic, astringent, antiperiodic

Primary Distribution

Medicinal and pharmaceutical plants are primarily distributed as a processed (dried) product to BC and other North American manufacturers of herbal products. Quality standards are important and will likely become more important.

Interest in medicinal and pharmaceutical plants is growing rapidly. St. John's wort, a plant classified as a noxious weed, is the main medicinal NTFP in BC. Several years ago, demand for St. John's wort increased dramatically based on widespread publicity about the anti-depressive characteristics of the plant, the "natural Prozac." The harvest ballooned over three years from about 10 000 lb. in BC and Washington state to an estimated 650 000 lb.

Oregon-grape is the second most popular crop in this category with an annual harvest of about 20 000 lb. Cedar oil, cascara bark and devil's club are the other main medicinal plants in BC.

The market for medicinals and pharmaceuticals is based on dried product. Drying requirements differ for each crop. For example, St. John's wort should be dried in shade or darkness. It is important to determine the proper method of drying with a buyer to ensure acceptance of your product.

It is also critical to ensure that you and the buyer are discussing the same plant as there may be more than one common name for it. Plant identification books usually include Latin or scientific names. For example, *Epilobium angustifolia* is commonly called fireweed or willow herb. Most buyers will want a certificate of botanical identity to accompany a shipment. In some cases it may be difficult to find a botanist qualified to do such an identification. It may be necessary to contact the botany department at a university or college.

Brokers are another marketing option for medicinals. They often have contacts and agreements with manufacturers.

You should attempt to pre-sell medicinal products. Be prepared to send a 100 gram sample and quote a price range—either delivered or FOB your property price. If the sample meets the buyer’s specifications for active ingredient levels, you can negotiate a purchase price. A broker will look, smell and taste your herbs to assess quality. A manufacturer may chemically analyze a sample to assess chemical constituents.

Ask the buyer to confirm the order in writing.

With a new buyer, request a deposit of 25 to 50% in advance of shipment. Once a relationship is established, payment can be requested within 5 to 30 days.

Regional medicinal plant and herb manufacturers and brokers will often publish “pick sheets,” which list the species and plant parts they purchase, acceptable drying techniques, and a price per kilogram delivered.

Floral Greenery

Common Name	End Use
Salal	Greenery
Western sword-fern	Greenery
Deer-fern	Greenery
Evergreen huckleberry	Greenery
Conifer cones	Christmas decorations, floral arrangements
Boxwood	Greenery
Bear-grass	Fresh/dried flowers
Cedar boughs	Aromatic oils
Conifer boughs	Christmas decorations, greenery
Moss	Filler in baskets or floral arrangements
Oregon grape	Greenery
Tall Oregon grape	Greenery
Scotch broom	Fresh flowers, greenery
Juniper	Aromatic oils
Red-flowering currant	Fresh flowers
Candystick	Fresh/dried flowers

In BC there are 130 salal companies that comprises an estimated 75–80% of BC floral greenery sales. The floral industry uses the deep green, leathery leaves and light green to red stems of salal as background material. Western sword-fern and deer-ferns, cedar boughs, evergreen huckleberry, boxwood and moss are other high demand floral greenery plants. Evergreen huckleberry and Oregon grape have fine featured evergreen leaves that are used as accents in floral arrangements. Ferns are popular fillers.

Seasonal Markets – Christmas

Evergreen boughs are harvested during fall and winter months for use in Christmas decorations, such as wreaths, garlands and swags. Tree species, such as noble fir, are preferred because they retain their needles longer after harvest. Douglas-fir is used for lower valued wreaths and swags. Western white pine is a mid-range priced species. Western redcedar is used to manufacture garland chains and as additions to wreaths. Holly and cones are other products that are harvested for Christmas decorations.

Primary Distribution

Floral greenery is primarily sold as a raw product (bunched) to local buyers who sell it to floral distributors.

Floral greenery buyers are based in a community and harvesters bring their products to the permanent buying location (which is often the buyer's home). These buyers sell to regional floral distributors in major metropolitan cities who then sell to retail floral operations throughout North America, Europe and parts of Asia.

Local buyers are the best floral greenery price sources. Salal is bought by the regular and short “bunch,” 1½ lb. To the bunch. Ferns are also bought by the “bunch,” but there are 50 fern pieces in a fern bunch.

Landscape Products

Native plants are flowers, grasses, shrubs and trees indigenous to the region prior to European settlement. Landscaping with native plants is increasingly popular for several reasons. Basically, native species are naturally adapted to the local climate so they are less costly to maintain, have relatively lower moisture and nutrient requirements and greater resistance to disease and pests.

Many buyers require that native plants be harvested in a sustainable manner. This means either growing rare or vulnerable species from seed or salvaging plants from developments such as road construction.

Tree and Shrub Species

Trembling aspen	Mock orange
Bog-laurel	Pink mountain heather
Buckbrush	Red elderberry
Bunchberry	Red flowering currant
Common juniper	Rocky Mountain juniper
Common snowberry or waxberry	Running clubmoss
Devil's club	Sitka clubmoss
Falsebox or mountain boxwood	Vine maple
Ground-cedar	Western teaberry
Ground pine	

Herb Species

Arctic lupine	Marsh violet
Brittle prickly pear cactus	Nuttal's bitter cress
Broad-leaved stonecrop	Oregon stonecrop
Common cattail	Pacific bleeding heart
Common scouring rush	Pale sedge
Deer fern	Plains prickly-pear cactus
Early blue violet	Red columbine
Few-flowered shootingstar	Round-leaved sundew
Heart-leaved arnica	Small flowered blue-eyed Mary
Licorice fern	Sword fern
Maidenhair fern	Yarrow
Maidenhair spleenwort	

Primary Distribution

Landscape products can be sold directly to local garden centres and/or directly to consumers.

This is one category that will likely require market research and planning. There is no simple well-established distribution process in the province. Native plants are being used in commercial landscape projects, in parks, rights-of-way and in reclamation and restoration projects, among others. Potential customers might include nurseries, landscapers and possibly, government agencies. However, there will be vast differences in market conditions throughout the province. If you are thinking about marketing native plants consider the following (among others):

- what species is there a demand for, where and what volumes
- who are the buyers and where are they
- how do you get the product to market and at what cost
- what quality specifications are expected by your buyer and the end user
- is the stable and market long term or volatile short term, or somewhere in between.

Retail prices are available at nurseries selling native plants in the Lower Mainland and on Vancouver Island. These prices would have to be discounted by appropriate margins and transportation costs to estimate a return to the producer.

Craft Products in BC (from Botanical Forest Products in BC)

Plant material used	Common name	Craft product or end use
Bark	Canoe birch or paper birch	Baskets
	Yellowtwig dogwood	Weaving
	Engelmann spruce	Rope
	White spruce	Birch bark canoes
	Black spruce	
	Western red cedar	
Wood	Western hemlock	
	Pacific fir	Furniture
	Bigleaf maple	Art pieces (carvings)
	Alder	Tools
	Canoe birch or paper birch	Ceremonial objects
	Nootka false cypress	Hunting bows
	Engelmann spruce	Totem poles
	Sitka spruce	Arrow shafts
	Beach pine	
	Quaking aspen	
	Beaked willow	
	Western yew	
	Western redcedar	War canoes
	Leaves	Kinnikinnick
Slough sedge		
Lambsquarter		baskets and other types of weaving
Strawberry-blite		
Cattail		
Bear-grass		
Whole Plants	Red-osier dogwood	Natural dyes used by cloth weavers
	Bittercherry	
	American bullrush	
Roots	Engelmann spruce	Baskets
	White spruce	Rope
	Black spruce	Weaving

Primary Distribution

Craft products can be distributed directly to retailers and/or directly to consumers.

By definition, handicrafts made from NTFPs are value added products. There are two well-established handicraft distribution channels: direct to retailers and direct to consumers. Gift trade shows for retailers are the primary method for reaching retailers. Farmers' markets, mall stands and Christmas craft fairs are excellent places to make direct consumer sales.

Recommended References

Small Woodlands Program of BC

A comprehensive 'Small Woodlands Library' is available on the web [www.swp.bc.ca]

Small Woodlands Program

A Guide to Agroforestry in BC. 2001. R. Hallman et al., Ministry of Agriculture Food
Small Woodlands Business Planning and Marketing Guidebook. 2002. of BC, Smithers
[www.swp.bc.ca]

BC Ministry of Forests

Christmas Tree Culture. 1988
Christmas Tree Farming. Publication B

BC Provincial Museum, Victoria

Guide to Common Edible Plants of British Columbia. Handbook 20
Guide to Common Mushrooms of British Columbia. Handbook 24
Food Plants of British Columbia Indians – Part I, Coastal Peoples. Handbook 34
Food Plants of British Columbia Indians – Part II, Interior Peoples. Handbook 36

Canadian Forestry Service

An Introduction to Christmas Tree Growing in Canada. 1982. Publication 1330
Common Insects and Diseases of Balsam Fir Christmas Trees. 1981. Publication 4328
Forest Mushrooms. Brochure, [<http://www.pfc.cfs.nrcan.gc.ca>]

National Museum of Canada, Ottawa

Wild Coffee and Tea Substitutes of Canada. 1978
Edible Wild Fruits and Nuts of Canada. 1979
Edible Wild Greens of Canada. 1980

BC Ministry of Agriculture, Food and Fisheries, *The Recognition and Life History of the Major Insects and Mite Pests of Ornamental Shrubs and Shade Trees of B.C.*

Schniutz, E.M. and L.B. Hamilton, 1979. *Plants That Poison*. Northland Press, Arizona

Gunther, Erna, *Ethnobotany of Western Washington. The Knowledge and Use of Indigenous Plants by Native Americans*. 1981. University of Washington

MacKinnon A. and J. Pojar, 1994. *Plants of Coastal British Columbia* Edmonton

Coupé R., A. MacKinnon and J. Pojar, 1992. *Plants of Northern British Columbia*. Edmonton

Coupé R., D. Lloyd and R. Parish, 1996, *Plants of Southern Interior British Columbia*. Edmonton

Lincoff, G. 1991, *Field Guide to North American Mushrooms*. The Audubon Society. New York

De Geus, N. 1995. *Botanical Forest Products in B.C.: An Overview*. MoF Publication

[www.pacificbotanicals.com] – Pacific Botanicals Inc., lists wholesale selling prices.

[www.vanisl.com/mushcash.html] mushroom price information

[www.island.net/~ntfp] *Beneath the Trees*, the North Island Non-Timber Forest Products (NTFP) Demonstration Project's newsletter.

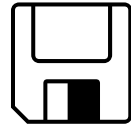

Introduction to Forest Certification

Marketing

In this chapter...

What is Forest Certification?	178
Forest Certification Programs	180
Recommended References	183

.....

What is Forest Certification?

Since 1992, when the UN Conference on the Environment and Development (UNCED) recognised that *sustainable forest management (SFM)* is a topic of global importance, there have been various national and international initiatives to define criteria and indicators of SFM and the mechanisms for assessing and monitoring their application. Forest certification has emerged as one of the tools designed to promote SFM through the development of voluntary standards and market based incentives (consumer demand and labelling).

Forest certification works through verification by an independent third party that the forest management of a defined forest area meets the standards set out by the certification program. There are essentially three parties involved in the certification process:

1. the *standards body* who develops the certification program, maintains the standard and accredits the certifiers to carry out certification against the standard;
2. the *independent certifier or registrar* who carries out the business of providing certification services (audits) to clients and is accredited by the standards body or national accreditation body;
3. and the *client* who is seeking certification and must demonstrate to the certifier that their forest management conforms with the requirements of the standard being sought.

The certification process involves the following steps:

1. Selection of a certifier/registrar and application for certification to them.
2. Pre-audit or scoping visit where the certifier visits your forest to review the current status of your forest management and assess your readiness to proceed to a certification audit and ensure that you understand the requirements of the certification system. (This step is sometimes optional.)
3. Review of your Forest Management Plan and related documents and audit planning by the certifier
4. Certification audit which will involve a thorough audit of your documentation, records, and management systems, the technical basis for your management plan, and your forest practices and operations on the ground to assess your conformance with the relevant standard. Depending on the standard being assessed the audit will also include interviews with stakeholders, First Nations, and any applicable regulatory agencies. At the end of the audit you will be notified if there are any non-conformances and whether you will be recommended for certification or require further work prior to certification.
5. If recommended for certification, a certificate will be awarded and you will receive an audit report and any pre-conditions (required actions or improvements) associated with the certification. At this point you will be entitled to market your wood as coming from a certified forest (except in the case of ISO 14001 where you may only advertise the fact that your environmental management system [not forest] has been certified). A certificate is normally valid for between 3–5 years depending on the certification system involved.

6. Surveillance audit. A certification must be maintained and this is accomplished through annual (or more frequent) surveillance audits by the certifier. The purpose of this is to check for ongoing conformance with the standard, and to check that you are addressing your pre-conditions and/or areas needing improvement.
7. Renewal audit. This is a full audit on the scale of the original certification audit that is carried out at three to five year intervals depending on the validity of your certificate. The purpose is to reassess conformance with the entire standard and establish the basis for renewing your certificate.

Forest certification is a voluntary process, and therefore is not regulated or legislated by government. It is something a woodland owner pursues for their own reasons often including: market access, recognition, and a demonstration or assurance to stakeholders that they are practicing sustainable forestry. Demand for certification is generated in the market place by retailers and consumers who choose to prefer products from a certified forest.

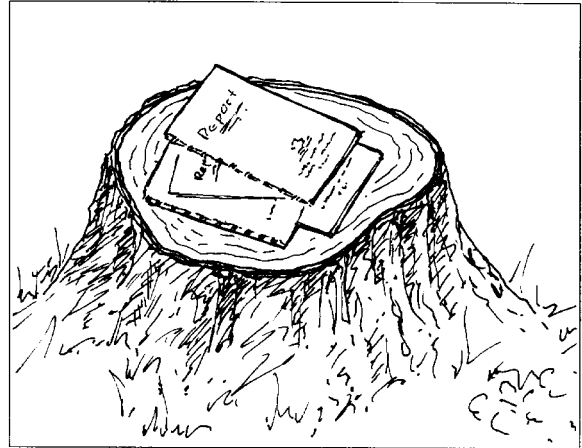

Some certification programs provide an actual label that is displayed on the product (eco-label) to show buyers that the wood product has originated from a certified forest. Large certified forest companies or mills are now also beginning to ask for certification from their wood suppliers which can have implications for woodland owners who rely on them as their primary market.

Certification programs can be regionally, nationally, or internationally based reflecting the market place they are designed to serve. In fact, there have been a plethora of systems emerge since the mid 1990s and trying to decide which one is most suitable for you can be confusing. In addition, a system developed in one region may not be recognised by the market place in another region creating another reason to choose carefully. Fortunately, many regional or national programs are working towards mutual recognition agreements that would allow for their recognition and acceptance across borders.

Not all certification programs are suitable or appropriate for small woodlands. The most significant issue for small woodland owners is usually the cost of certification which can easily run between \$5,000–\$15,000 and up with annual maintenance fees on top of that. Several forest certification programs provide for group certification of small woodlands as a means of spreading the costs. However, owners must first organise themselves and develop a mechanism to monitor conformance with the standards by all members of the group.

Another alternative is to work with local forest companies or mills which are involved in certification or already certified in order to piggy back your certification process onto their process. This can reduce costs and effort significantly. In some cases where a mill or company relies on your production, and requires certified wood, it may be possible to ask them to contribute to the costs of certification of your woodland.

Woodland owners are, therefore, advised to evaluate the different systems relative to their own goals, marketing needs and customer requirements before embarking on any one of the certification processes. The following section outlines the most common certification schemes used in Canada.

Forest Certification Programs

The parameters and expectations of various forest certification programs can vary a great deal. Most forest certification programs are based on the premise that to be sustainable, forest management must incorporate a balance of social, economic, and ecological criteria. There are two broad categories of certification programs although some programs incorporate elements of both:

1. process (management system) oriented, whereby the client must establish a forest management or environmental management system to help plan and manage forest operations (e.g., ISO 14001, CAN-CSA Z809-96, SFI)
2. and performance oriented whereby the clients forest management must conform with a specified set of performance principles and criteria (e.g., FSC, CAN-CSA Z809-96, SFI).

ISO 14001-96

This is an international management system standard that permits the certification of an organisation's environmental management system (EMS) (this is not a forest certification standard in the sense that it does not certify the forest). An EMS consists of a plan-do-check-act framework for identifying and managing activities that can have an environmental impact. The standard is generic in that it can be applied to a wide range of industry sectors (e.g., chemical, petroleum, manufacturing, airports, service industry, etc) and while it is not specific to forestry there is a technical guidance document (ISO 14061) that was developed specifically for forestry organisations who seek to implement ISO 14001. The management system is designed to reduce liabilities, demonstrate due diligence, and can create efficiencies for larger organisations. ISO 14001 certification is not generally appropriate for small woodlands, however all organisations will benefit from implementing the elements of the standard whether they seek certification or not.

ISO stands for the International Organization for Standardization (ISO) which is a Swiss-based federation of worldwide national standards bodies. ISO oversees the development of standards but does not provide certification services. For information on ISO 14001 registrars in Canada or to obtain copies of the standard, contact the Standards Council of Canada (SCC).

CAN-CSA Z809-96 (SFM standard)

The Sustainable Forest Management Standard (CAN-CSA Z809-96) is a national sustainable forest management standard for Canada. It includes both management system elements and performance requirements. The system elements require that the forest (or woodland) manager set in place a comprehensive Sustainable Forest Management system based loosely on the ISO 14001 framework. The performance elements require the forest owner or manager engage in a public consultation process to establish values and goals

for the woodland, to establish on-the-ground performance indicators and associated objectives that address 21 critical elements derived from the Canadian Criteria and Indicators for Sustainable Forest Management, and to prepare a sustainable forest management plans that includes long term forecasts of future indicator levels. The SFM certification program also provides for chain of custody certification and the labelling of products derived from wood originating from Z809 certified forests.

The SFM standard was developed with broad stakeholder input and is maintained by the Canadian Standards Association (CSA). The SFM standard was developed with consideration for the unique needs of small private woodlands and includes associated guidance material in the form of case studies for implementation at a woodland level or by a group of woodlands, however it is actually quite onerous, better suited to larger forestry organisations, and consequently has not yet been applied by any woodlands.

The CSA is a national standards organisation which develops standards and certification programs for a wide range of systems, processes and products (e.g., toasters, workboots, lightbulbs, etc). Certification services to the CSA standard are provided by independent certifiers/registrars who are accredited by the Standards Council of Canada (SCC). Contact the SCC for a list of certifiers. Contact the CSA to obtain copies of the standard and associated guidance material.

Forest Stewardship Council (FSC) Standard for Well-managed Forests

The FSC standard is an international standard for good forest management developed by the Forest Stewardship Council, a non-governmental organization (NGO) with headquarters in Mexico. The standard is performance based and requires that forest managers demonstrate that their forest is being managed according to 10 worldwide principles of environmentally appropriate, socially beneficial, and economically viable forest management. The FSC Principles and Criteria (P&C) include:

- compliance with applicable legislation and commitment to the FSC P&C
- recognition and integration of community interests
- First Nations and workers rights
- production of a range of sustainable forest products and services (multiple benefits)
- environmental impact assessment
- safeguards to protect rare, threatened and endangered species
- maintaining ecological functions
- establishment of a network of protected areas
- guidelines to protect soil and water
- minimising pesticide use and not using certain types of chemicals
- restricting forest conversion of natural forests to other uses including plantations
- a forest management plan
- a monitoring program
- maintenance of high conservation value forests
- special requirements for plantation management.

Because the international principles and criteria are somewhat general in nature and because forest types, socio economic, and regulatory circumstances vary widely around the world, the FSC process allows for the development of regional interpretations of the international standard by national or regional FSC bodies. These regional interpretations tend to be more comprehensive than the international set, include significant

interpretative guidance, and are called **regional standards**. The regional standards supersede the international standard for the region once ratified by the National FSC body and approved by the international FSC. Regional standards are being developed for BC and can be obtained from the FSC BC website.

FSC certification applies to the forest being certified rather than the forest manager. FSC also provides for chain of custody certification of the supply and manufacturing chain as well as product labelling that guarantees that the end product originates from a certified forest. Group certification and/or resource manager certification is also possible under the FSC system to facilitate access to certification by woodland owners.

The FSC standard is widely supported and recognised by various environmental groups and has been successfully promoted in the market place by retail organisations or buyers groups of companies who commit to only purchasing or preferring FSC certified product. This has created a significant demand worldwide, especially in the European and US markets, that has supported the growth of the certification program. The FSC standard is commonly promoted as the ‘gold standard’ for forest certification.

The FSC does not conduct certifications, but rather grants certifying organizations the right to provide FSC certification services. There are relatively few FSC accredited certifiers worldwide and many work in a number of countries and jurisdictions. There are two BC based certifiers. For information on certification bodies and their contact information visit the FSC Canada or FSC BC websites.

Sustainable Forestry Initiative (SFI)

The Sustainable Forestry Initiative (SFI) standard is a North American (US & Canada) performance based standard developed by the American Forest and Paper Association (AF&PA) as a requirement of membership and with the objective of promoting and improving performance of industry and landowners with respect to sustainable forestry. The standard addresses forest management criteria, wood procurement, extension and communication (to suppliers – usually private woodlands), and continual improvement. It is based on 5 principles and 12 objectives addressing sustainable forestry, responsible practices, forest health & productivity, protection of special sites, and continuous improvement and it uses 35 performance measures, 73 core indicators, and 158 other indicators which can be added to by the client or verifier to assess conformance.

The standard is not ideally suited for application by small woodlands. It was designed for industrial forest companies and processing facilities. However it is unique and relevant to woodland owners in that it requires the certified company to provide outreach and extension services to its suppliers (i.e., woodland owners) in order to help them implement sustainable forestry practices.

Certification (or verification) services are provided by AF&PA approved verifiers. For a list of approved verifiers, copies of the standard, and a list of certified companies in BC visit the SFI website.

Other initiatives

There are many other certification initiatives out there including several in other jurisdictions that cater to private woodlands. These can be checked out on the internet, two notable programs include the Pan European Forest Certification Program (PEFC) which was developed for private woodland owners in Europe and has certified a

significant area of private woodlands in several European countries, and the American Tree Farm System (ATFS) in the US which is oriented towards private woodland owners.

Few certification systems currently available in Canada are ideally suited to small woodlands or accessible from a cost perspective. The Canadian Woodlot Federation is in the process of developing a new standard that will be designed specifically with small woodlands in mind and this should be available for consideration by 2003.

There is a large amount of information available about certification on the internet, so for more information consult the recommended web pages below.

Recommended References

Small Woodlands Program of BC

A comprehensive 'Small Woodlands Library' is available on the web [www.swp.bc.ca]

Forest Stewardship Council – Canada

[www.fscCanada.org]

Forest Stewardship Council – BC

[www.fsc-bc.org]

Canadian Standards Association

[www.csa.ca]

Standards Council of Canada

[www.scc.ca]

International Organization for Standardization

[www.iso.ch]

Pan European Forest Certification Council

[www.pefc.org]

Sustainable Forestry Initiative

[<http://woodlands.mead.com>]

American Tree Farm System

[www.treefarmssystem.org]

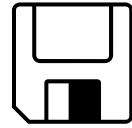

Reforestation Basics

Reforestation

In this chapter...

Introduction	186
Site Assessment and Species Selection	187
Natural Regeneration.	188
Preparing the Seedbed.	189
Artificial Regeneration.	192
Other Considerations.	199
Recommended References	200

.....

Introduction

Reforestation is the process of renewal during which a new stand of trees is regenerated on a forest site following a disturbance such as fire, windthrow, disease mortality or logging. Reforestation is an ongoing activity in a managed woodland following harvesting, and requires knowledge of the forest site, the species involved, risks and constraints and the establishment techniques available. Reforestation also requires advance planning, as well as follow-up monitoring and tending to be successful.

Afforestation is similar to reforestation but involves establishing trees on sites that have previously been used for other purposes such as farm fields, old pasture lands, or lands that have been degraded in the past or subject to natural soil disturbing processes such as landslides, floods or glacial activity.

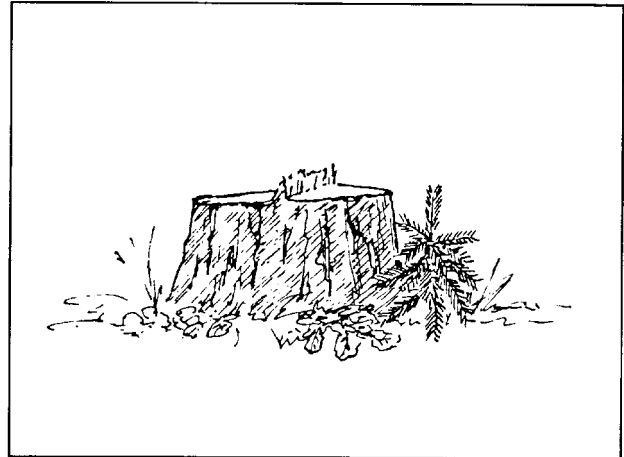

There are a number of ways to approach reforestation.

1. You can let nature handle it (natural regeneration)
2. You can assist nature (seed tree selection, site preparation)
3. You can shortcut nature (artificial regeneration)
4. You can carry out a combination of the above methods.

The method you choose will depend on a number of things, including:

- your management goals
- the presence of a seed source
- the site capability and characteristics
- your ability to finance reforestation
- the time period in which you want to establish a new crop.

Site Assessment and Species Selection

The first steps in the reforestation process are site assessment and species selection.

Site Assessment

Reforestation strategies are determined on the basis of an ecological and silvicultural assessment of the site (called the silviculture prescription), which is normally carried out prior to harvesting. Site assessment looks at the physical and productive characteristics of the site including soil characteristics, drainage and moisture regime, and nutrient status and capability. The site assessment also looks at what species are currently growing on site as well as at any potential constraints to reforestation including brush hazard, forest health issues and wildlife concerns.

Handbooks that detail the procedures of site diagnosis, species selection and site preparation have been developed for most of the forest regions of the province, and are available for reference at local offices of the Ministry of Forests. A discussion with a forester is also strongly recommended to help formulate your reforestation strategy.

Species Selection

Species selection for reforestation will depend on your personal goals as well as on the moisture and nutrient capability of your site, the silvics (shade tolerance, growth rates, elevation range, site preferences) of the species involved, and by what is currently growing on site. Species selection guidelines for the full range of different site types and regional locations in the province are available through the Ministry of Forests, your local forest consultants, or your Woodlot Association.

The species you grow will be influenced, in part, by the stage at which you begin to manage your woodland property. Where the woodland is forested, you may decide to regenerate the area naturally, with species of the current stand. Or, you may decide to replace the crop, by planting with a species more suited to your personal goals.

Where you have inherited an area that is 'tree-free,' as pasture or as cleared land after harvesting or fire, the selection of tree species will be based on a number of factors, including the characteristics of the planting site, such as exposure, soil type, elevation and slope.

A quick survey of any stumps on-site, as well as the mature forest in neighbouring stands, will give you an idea of the species that have been nature's choice for the area. Keep in mind, however, that the forces that cleared this site may have effectively pushed it to an earlier successional stage than that of neighbouring stands. For instance if your site formerly supported a very old climax stand of slow growing shade tolerant species, and was subsequently burned or site prepared, it may be appropriate (and desirable) to replace the climax species with faster growing pioneer species, even if this species is not represented in the surrounding forest area.

Once the species suited to the area have been identified, you must consider your intermediate and end-product goals. Are the trees being produced for wildlife habitat? Soil stability and conservation? Streambank improvement? Windbreaks? Fuelwood? Sawlogs? Christmas trees? Is a mixture of species desired, such as hardwoods for annual

firewood harvest and softwoods for long-term investment? When these questions have been answered and the ideal species have been selected, the next decision is how to introduce them to the site.

Natural Regeneration

As openings appear in the forest, they are quickly filled with new growth that seeds in from other plants in the area. This new growth will include a variety of species of small plants, shrubs and trees adapted to the site.

In a managed forest, the openings are created with the next crop in mind. The silvicultural system includes a reforestation strategy to prepare the site for the species you select. For instance, you can influence natural regeneration by removing all trees except those of the preferred species, or enhance seedling establishment by preparing a seedbed.

All the silvicultural systems can be used to obtain natural regeneration. Your choice of a system will be influenced mainly by the species you wish to regenerate. For instance, if you wish to regenerate a shade tolerant species, you may require a shelterwood, seedtree or selection system to produce the desired results. Conversely, if you wish to regenerate shade intolerant species, then a clearcut or patch cut may be required.

Your choice of species will likely be a trade-off between what you can get for 'free' as natural regeneration, and how well it will serve your goals, versus the benefits you would expect from a crop that costs you something to plant. Natural regeneration will likely be the most cost-effective means of reforesting a small-scale woodland property, especially in cases where you are able to undertake any follow-up stand tending yourself.

The success of natural regeneration relies heavily on an abundance of seed, so it is a good idea to monitor the cone crops of your seed sources. When the new crop is unevenly distributed throughout the area, it can be supplemented with the transplanting of wildlings (natural stock from other areas on the woodland) or nursery stock. Most tree species will regenerate naturally depending upon site conditions and seed source. If your natural regeneration is too successful, you actually have to reduce the density of trees through spacing.

The major consideration is often related to how long you are willing to wait for the next crop. It is a gamble: on one hand, natural regeneration is 'free,' the seedlings are genetically well adapted to the site, and there is no transplant shock. On the other hand, if you have a particularly rich site with the potential for a heavy brush competition, you may have to undertake expensive brushing and weeding treatments to release the natural seedlings two or three years post-harvesting. If you plant immediately after logging, the trees have some time to thrive before the brush recovers.

Increasing Natural Seed Production

There are methods by which a woodland owner can enhance the natural production of seed as well as timing the seed production to coincide with harvesting operations. There are several considerations in choosing possible parent trees:

- Are there trees of the desired species for regeneration within or adjacent to the block?
- Are they healthy and with desirable form?

- Are they upwind from the block?
- Are they windfirm and not on shallow soils or rock outcroppings?

It is important to know a bit about how trees produce seed. We will use Douglas-fir as an example. In early spring in year one, the tree is forming buds at various locations in the crown. There is a process called ‘differentiation,’ wherein the buds determine whether to become vegetative (needles) or sexual (male and female structures or cones). This choice to produce a majority of sexual buds can be influenced by the woodland manager by stressing the tree.

A common reaction of many plants to stress is to allocate maximum resources to reproduction. In conifers, if you make a thin kerf cut, like with a sharp lino knife, through the bark severing the cambium, the tree treats this as a fatal wound and forms many sexual buds. Once this decision is made by the tree, there is no turning back. The tree believes it is dying, and makes cone or flower buds. However, this thin cut soon heals over and nutrients and water are once more moving throughout the tree. The tree now has many flower buds which receive full nutrition. Over the summer of year one, the buds rest dormant. In the spring of year two, the flowers and pollen structures emerge and form cones which will release seed in the late summer of year two, eighteen months more or less, since your first knife cut.

There are other methods to enhance seed set. Root pruning by machine can also stress the tree to produce more seeds, but it may be inadvisable as it can compromise tree stability, and is impractical in the natural forest setting.

Preparing the Seedbed

Site preparation is carried out to ready the soil to receive seeds or seedlings, reduce fire hazard, and control pests or diseases. This may involve clearing, burning, or breaking up slash or windfall which create obstacles to natural seed in or planting. Removing competing vegetation, or exposing mineral soil creates a favourable seedbed.

The decision as to the appropriate site preparation method depends on the site conditions, silvicultural system, and management objectives for the area. The costs of site preparation must be weighed against the potential delay in regeneration if no preparation is done. Where natural regeneration is being relied upon, seeding-in may be spotty and seed germination may be poor on sites without advance seedbed preparation. On areas scheduled for planting, consideration must be given to the number and distribution of plantable spots, as well as the factors (such as slash) that will affect planting productivity.

The timing and method of site preparation is planned in coordination with the selection of regeneration method. Where natural regeneration is being encouraged, harvesting and site preparation should be done, if possible, to coincide with a good seed year of the favoured species. Planted stock performance can also be enhanced by the removal of competing vegetation. In general, site preparation is carried out in the late summer or fall of the year before planting.

Mechanical Site Preparation

Sites are usually mechanically prepared by piling slash, mixing, mounding or scalping the forest floor. The choice of treatment depends on the needs of the species you wish to regenerate as well as site, climate and cost considerations. These activities are carried out

manually with hand tools, mechanically with heavy equipment, or by the use of chemicals or prescribed burning.

Specialized equipment has been developed for site preparation on large timber production areas. For the small-scale woodland owner, it is also possible to move slash and expose mineral soil by fitting special blades or chains to tractors or skidders.

A hoe (excavator) is an excellent site preparation tool. Fitted with a rake and a thumb, a hoe can treat large areas with less ground compaction than a wheeled machine due to the reach of the arm. Given adequate hydraulic capacity, a hoe can be fitted with a 'brush hog' (heavy-duty mower) to grind the slash and stumps into mulch. Such a treatment often reduces the re-sprouting of some brush or undesired hardwood species such as alder or poplars. A hoe can also pile slash at the edge of a reforestation block where it can decompose, providing a 'compost pile' which slowly releases nutrients and conserves moisture.

Scarification

Drag scarification, a process which scrapes off the surface of the site to expose mineral soil, can be achieved by dragging heavy chains or drums behind a tractor or skidder. This technique is commonly used to promote natural pine regeneration in the interior of BC. Dragging aligns and crushes slash, exposes mineral soil and brings cones close to the ground where they release their seeds onto the freshly prepared seedbed.

Drag scarification units, whether commercially produced or 'home-built' are somewhat cumbersome and best suited to large, relatively *flat* areas with low stumps and light slash. More maneuverable equipment, such as disc trenchers, can be used to prepare a mineral soil seedbed in partially cut stands. Other machines use blade attachments to move slash and loosen top soil. This type of scarification is better suited to areas of heavy slash accumulations or large piece sizes. For small areas of your woodland, there is a tool that can be fitted to a power saw for removing duff. It is marketed as a 'Power Screener.'

Factors such as soil type, slope, stumps, the volume and size of slash and the amount of brush on site must be considered when selecting site preparation

equipment. Brush rakes or V-plows should not be used on sites where stumps are large and more closely spaced than the width of the attached blade. Dry sites with slopes below 20% are the favoured conditions for mechanical site preparation. On steeper slopes, equipment productivity diminishes while site preparation costs go up.

In some cases the action of skidders during the harvesting process can provide sufficient scarification to produce an adequate seedbed. However, heavy traffic can compact the soil and impair seedling establishment. Where scrub growth occurs on small areas or heavy equipment cannot be used, brush and weed trees can be cut manually with brush

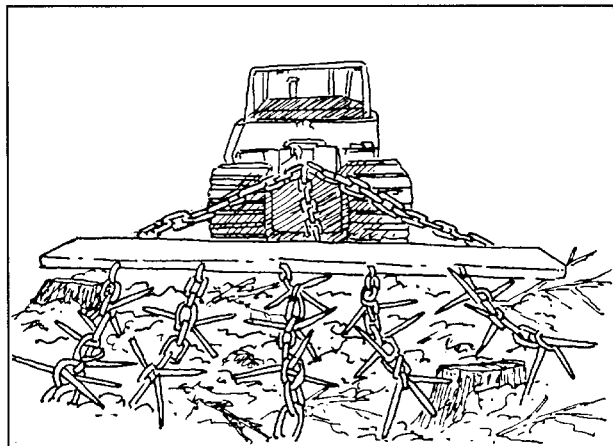

hooks, brush saws or power saws. Wet sites which will not support heavier equipment may also require hand clearing.

Burning

Burning is another common and effective means of disposing of competing vegetation and logging slash prior to planting. Prescribed burning is usually the easiest and least expensive method of site preparation, though on small areas it can be difficult to control. Applied properly, it can accomplish a number of objectives, including:

- the removal of debris
- reduction of fire hazard
- removal of pests and competing vegetation
- the exposure of mineral soil.

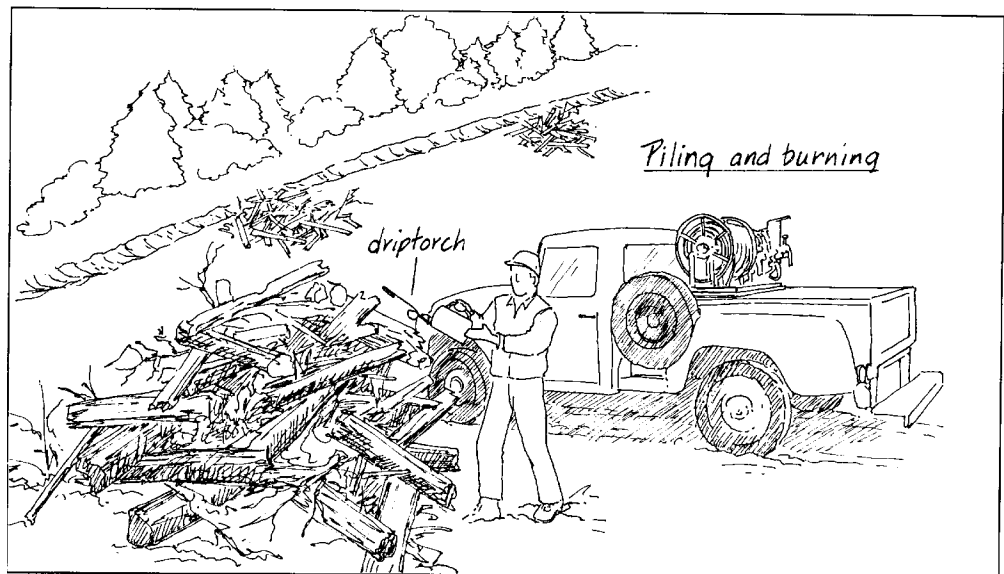

Used improperly, burning can destroy many of the nutrients available in the small fine twigs and needles and, unless carefully planned and monitored, can create big problems very quickly.

An alternative is to pile the slash on stumps or other non-productive areas within, or adjacent to the harvesting area. You may be surprised how quickly the pile decomposes. A brush pile can provide habitat for small mammals and insect-eating birds as well as slowly releasing nutrients and moisture.

A combination of windrowing or piling of slash and burning is used on sites with unevenly spread slash, or where other site values must be protected. This form of site preparation is commonly and successfully applied to small woodland holdings. Broadcast burning is used on sites with high slash loads, deep soils and a thick litter or humus layer. This technique is used less often as it is harder to implement and more difficult to control.

The district office of the Ministry of Forests should be consulted when any burning is being considered for an area. Burning permits are required for provincial lands (Crown and private).

Artificial Regeneration

When more control over the species, spacing or timing of regeneration is desired, areas are regenerated artificially. The regeneration process includes species selection, site preparation and either direct seeding or seedling production and planting. Although you may only be actively involved in the site preparation and seeding or planting stages, an understanding of the whole process will help you make decisions regarding things such as stock type, seedling age and the supervision of on-site activities.

Direct Seeding

In general, direct seeding is not a recommended form of forest regeneration. Although it may at first appear to be a very inexpensive means of reforestation, the toll taken by predators such as rodents, birds and insects, can drastically affect the regeneration success. Further, the method can often lead to significant follow-up costs for fill-in planting, brushing and juvenile spacing.

On a special project basis, direct seeding may appeal to woodland owners interested in the process of forestry, who would also like to become involved in cone collection, extraction and the treatment of seeds. An instructional unit on seed collection and germination entitled 'Forest Nursery Studies' is available from the BC Teachers' Federation (see references at end of chapter). As an experimental or educational method, direct seeding may be appropriate, but for ensuring the regeneration of a forest crop in the minimum time period, planting is the better method.

Planting

Planting not only allows you to select the favoured species, but gives it a one to five-year head start on other plants that will sprout from local seed. Planting stock comes in two basic forms. *Bareroot* stock, as it sounds, is grown in nursery seedbeds from which the seedlings are 'lifted' and transplanted to field sites. *Plug* stock is grown in containers, and removed from the container prior to outplanting in the field. The stock is often grown in large styrofoam blocks and when removed from these containers the seedlings retain the nursery soil bound up in their roots. This acts like a packed lunch to help sustain them while they get settled in their new forest land environment.

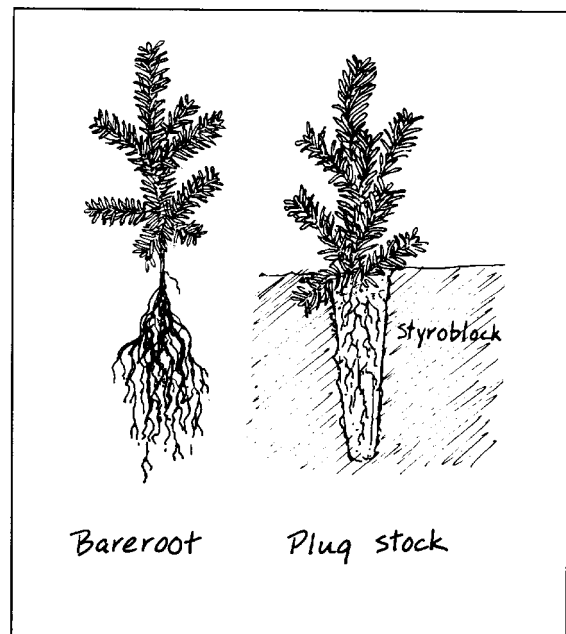

There are also *transplants*; seedlings grown for one year in a container, then transplanted to an open field for an additional year or two growth. These 'jumbos' are cursed by tree planters, but loved by foresters trying to establish a crop on a brushy site.

Choosing Your Stock

The type and size of planting stock you choose will depend on the amount of brush competition, soil characteristics, and potential for browse by domestic livestock or wildlife on the site. The choice of stock should be based on the best performance at the least cost. Where competition from other plants is a problem, larger stock outperforms smaller stock. Where site conditions are severe, plug stock can give the seedling the extra nutrients and protection that may ensure its survival. Plugs can be planted at a very young age since their roots are protected and fed by the rich soil in which they were seeded. Bareroot seedlings must be a little larger before planting in the field since their roots are not surrounded by a protective and nutrient-rich layer of nursery soil.

The age of planting stock is identified by a two number code. The first number indicates the number of years the seedling has grown in a container or nursery seedbed, the second number gives the number of years the seedling has grown in a transplant seedbed. Added together these numbers give the age of the seedling. A 1+0 plug is one year old, a 2+0 is two years old. If the plug is transplanted into a field to grow larger, it can be a 1+1 - a two year old seedling with one year in the container greenhouse and another in the field.

The example below explains the label:

Sx PSB 412A 1+0 Sp	
Sx	Interior Spruce
PSB	the container type is a Plug Styrofoam Block
412A	the growing cavity is 4 cm diameter by 12 cm deep, 77 cavities per block
1	age is one year
+0	it is not transplanted
Sp	planting season in Spring

Where site conditions are favourable, less expensive bareroot or smaller (1+0 or 2+0) plug stock is recommended. Such stock is also cost-effective when a 'shot-gun' approach (planting lots of small seedlings) has a higher chance of attaining a desired stocking level than does the planting of fewer, larger seedlings. However, since site conditions are not always ideal, the following table indicates the conditions that affect the choice of stock type.

This table indicates, in broad terms, the stock type most suited to general site conditions. However, the 'best' choice of species and stock for your site is not always straightforward. Large transplant stock is often planted on sites that have competing vegetation since the larger size gives it an advantage over the competition. It is strongly recommended that you seek the advice of the Ministry of Forests, your local woodlot association, or a local tree nursery when choosing the species and stock type for your reforestation program since it sets the stage for the forest you (and your children) will be working with in the years to come.

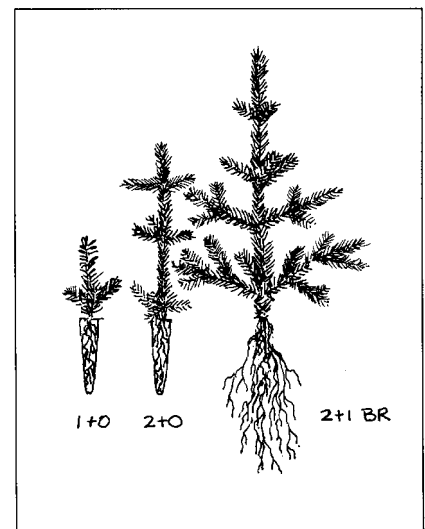

Site Conditions and Choice of Stock					
Site Conditions	Bareroot		Plugs (PSB)		
	2+0	Trans-plants	211	313	415
1. Limited moisture			✓	✓	
2. Heavy vegetation competition		✓		✓	✓
3. Heavy slash			✓	✓	
4. Organic layer 15+ cm	✓	✓		✓	
5. Soils – shallow			✓	✓	
6. Soils – rocky			✓	✓	
7. Soils – loose	✓	✓			
8. Soils – compacted			✓	✓	

Planning Ahead

Since seedlings take a year or more to produce, it is necessary to register a sowing request with the nursery from which you will be obtaining stock. The request should be made in advance, usually before harvesting begins, and at minimum, about a year and a half prior to planting. For instance, if you harvest this fall, you may prepare the site next fall, and plant the following spring.

Though surplus seedlings may be available once all orders are filled in the spring, in general it is not worth the risk. Planting is expensive, you only want to do it once, and it is worth the effort of planning for. The stock must be grown from seed suited to the characteristics of your woodland. The source of a seed is called its *provenance* and should closely

match the planting site in terms of climate, elevation and geographical location. Do not use seed or seedlings from high elevations if you are establishing a low elevation forest or *vice versa*.

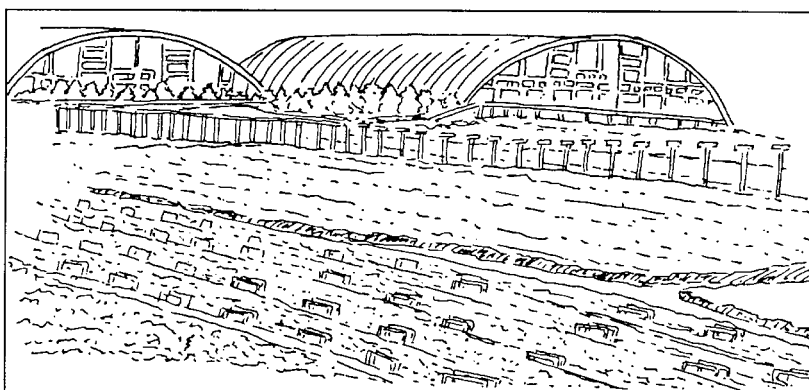

Seedlings must be purchased by the operator. It is common for nurseries to require a down payment with the sowing request, a progress payment on inventory, and the final payment on lifting. If you have given the nursery your target specifications for the seedlings (height, diameter), examine the seedlings closely and only pay for them if they realistically meet your standards. The price of seedlings will vary with the size and type of stock.

If your reforestation area is small, you may consider the transplanting of wildlings. Some woodland operators have found this a successful and relatively inexpensive way of redistributing seedlings in an area, especially helpful in situations where natural regeneration has come in unevenly. You may even consider setting up a ‘bush nursery’ on your woodland to grow your own stock for special purposes or fill-planting.

Often a used gravel pit, or exposed roadside adjacent to a stand of trees of the desired species will be covered with natural regeneration. Since you will be “bare-rooting” the seedlings, it is important to preserve as much of the root system as possible. For this reason, you will have better survival with seedlings less than two years old. More established older seedlings will have deep and spreading root systems which will be unavoidably damaged in transplanting.

Planting With Care

Planting is carried out with the best success in the spring, when temperatures are moderate and soil moisture is up. Spring planting should begin soon after snowmelt to maximize the amount of time the seedling has to become established before the summer dry season. The southern and western exposures should be planted first since these are the areas that receive the greatest amount of sun and usually dry out first.

Seedling care, between the time the stock leaves the nursery and is planted, is extremely important. One of the biggest causes of seedling death is from overheating. In transit, stock should be kept cool and ventilated and protected from direct sunshine and wind. While stock is on-site awaiting planting, it should be stored in a shaded place out of the wind. With plug stock, open the tops of the shipping cartons to prevent overheating, and water lightly if necessary. Roots should be kept moist at all times. Bareroot stock is especially vulnerable to roots drying out, and should be planted as soon as possible after



lifting. Where planting stock has been frozen, thaw slowly. Keep boxes sealed and in cool, shady conditions and monitor temperature closely to prevent overheating. Seedlings “breathe and perspire” just like you and me, and if there is no way to replenish the moisture lost through respiration, will be mortality or at least weakened trees.

The number of seedlings planted per hectare will reflect the management objectives of the woodland operator. Wide spacing, with 3 metres between seedlings, may be prescribed where juvenile spacing is not planned. However, where sawlogs are the desired end-product, closer spacing may be desirable to keep branch size down and encourage natural pruning. Spacing must also take account of seedling mortality. If trees are planted at a wide spacing, it may be necessary to carry out subsequent fill-in planting

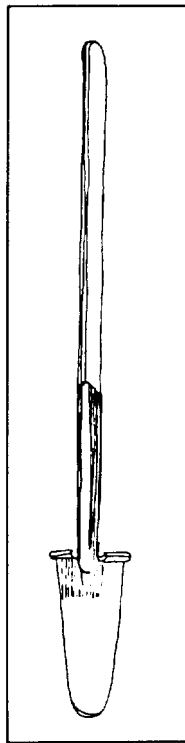

in areas where original stock fails to survive. Recommended stocking levels are set for each of the Forest Regions. Check with the district office of the Ministry of Forests.

Though a variety of tools (mattocks, dibbles, and seedling 'guns') have been used to plant trees in the past, most stock is currently planted with a special shovel. Planting bags strap around the waist with shoulder/chest straps to help carry the weight. You should keep some damp material such as moss or cloth in the bottom of the bag to keep the seedlings moist until planting.

Successful planting depends on starting with good quality, healthy stock suited to the conditions of the site, followed by good stock handling procedures, careful selection and preparation of the planting hole, and proper planting of the seedling.

'Screefing' is carried out at individual planting sites to clear the area surrounding the seedling and to reduce competition for moisture and soil nutrients. The planting hole should be large enough to accommodate the full length of the roots. If the roots are bent or J-rooted, the tree may grow for several years, then fall over due to the instability of the supporting root structure. The tree should be planted firmly and tightly without air pockets that could dry out the roots.

Tree Planting Guidelines:

- choose planting spots carefully, depending on species' needs
- clear immediate area of debris and competing vegetation
- make planting hole deep enough to accommodate roots without bending
- plant tree upright, and to the root collar
- fill soil in and around roots to remove air pockets
- tamp down soil firmly around planted seedling.

Reforestation costs will vary with the number of trees per hectare, the degree of site preparation needed, and the size and type of planting stock. All these will affect the productivity of the planters, as will slope, access and ground conditions.

Quality means everything in planting. The quality of your reforestation plan from the choice of species and stock, to the selection of individual planting sites will influence the cost-effectiveness and final success of your reforestation program. The condition of the seedling when it goes into the ground, and how well it is planted are the final keys to survival.

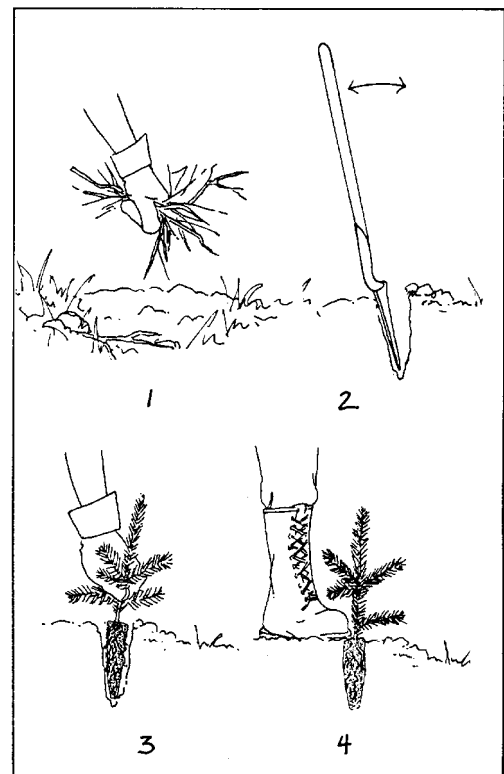

How Many Trees Do I Plant?

The number of seedlings planted depends on your management objectives. Less trees per hectare provides more room and nutrients for each tree but will result in larger branch size. Wider spacing may allow brush species to gain height, possibly overtaking the seedlings before the tree canopy can join. If you are interested in agro-forestry applications, such as grazing or Christmas tree production your spacing may be wider.

Too many stems will be expensive, and will require juvenile spacing in the near future. Packing them in can also cause stand stagnation from inter-tree competition. The positive aspect is quicker site domination by preferred species, greater **initial** height growth, and smaller branches with earlier self-pruning on shade intolerant species.

Tree/ha	Trees /plot*	Triangular spacing inter-tree spacing (m)
2500	12.5	2.15
2400	12	2.19
2300	11.5	2.24
2200	11	2.29
2100	10.5	2.34
2000	10	2.40
1900	9.5	2.47
1800	9	2.53
1700	8.5	2.61
1600	8	2.69
1500	7.5	2.77
1500	7	2.87
1400	6.5	2.98
1300	6	3.10
1200	5.5	3.24
1100	5	3.40
900	4.5	3.58
800	4	3.80
700	3.5	4.06
600	3	4.39
500	2.5	4.81
400	2	5.37

* Plot Radius: 3.99 m = 50 m²; Plot Multiplier = 200

Monitoring The New Crop?

Reforestation does not end when regeneration has been achieved. That is, reforestation means more than putting trees back in the ground; it means re-establishing a forest. A stand cannot be considered to have successfully reestablished until the trees within it reach what is known as the free-growing stage, having survived infant mortality and early competition from other vegetation.

Therefore, following natural or artificial regeneration, a number of check-ups must be carried out on a stand to see that it has been properly established, and to monitor how it is progressing. There are many factors that can affect the success of the regenerated site, and it is important to identify any problems as early as possible in order to protect your investment and save you time and money down the road.

These check ups are are known as silviculture surveys, and usually involve collecting information to assess the stocking, plantability, regeneration performance and free-growing status of the site.

During and After Planting

During planting it is important to check on the quality of the planting job on a continuous basis. Check that:

- the right mix of species has being planted
- the spacing is according to the specifications (it is easy to plant too many trees which can end up being very costly)

- the seedlings are being properly planted (in the right soil, with the right root position – you will have to dig some up to check this).

One to Two Years After Planting

Within the first two years after establishment you will need to check on the survival of your regeneration and the stocking of the site.

- Check whether any parts of your plantation have failed and try to assess why (site factors, environmental factors, seedling handling or quality factors, inadequate natural seed in).
- Check whether there are any gaps in the stocking of the site that may require fill planting.
- Check whether brush competition poses a risk to the survival of your seedlings or natural regeneration.
- Check whether animal browsing or stem damage (i.e., voles or insects) is a problem.
- Decide whether you need to take action such as fill planting, brushing, browse protection.

Every Two to Three Years Until Free to Grow

Check on the performance of your regenerating stand until it is well established and is ‘free to grow’ on its own without the need for further intervention.

- Check survival and health.
- Check performance by measuring leader growth and comparing to standards for the site.
- Check brush competition.
- Check stand density (naturally regenerated stands that are too dense can stagnate).
- Decide whether you need to take action such as fill planting, brushing or spacing.

Free-growing status is considered to have been achieved when the individual trees are as high as, or higher than the neighbouring brush competition and that they have approximately 1 metre of free space surrounding their crowns. This may take from five to ten years depending on the site and the severity of brush competition. At this point, they are firmly

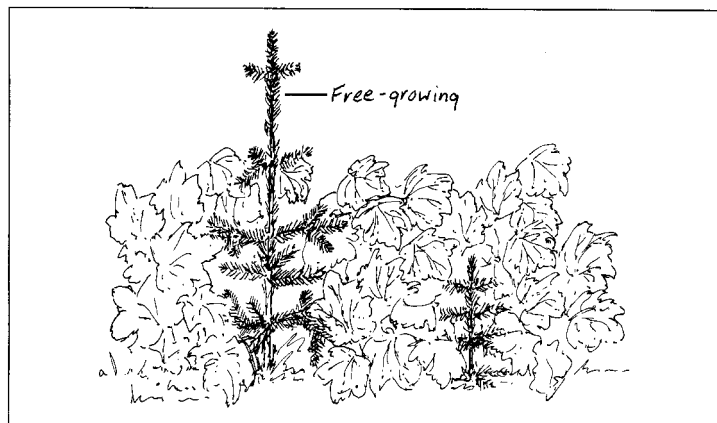

established and are part of a system of interrelationships with their neighbours. This system of connections forms a balance and an identity which we define as a stand of trees.

Other Considerations

Browse Protection

In many parts of the province, browsing by ungulates (deer, elk and moose), or even beaver, hares, mice or voles, can destroy overnight the planning, expense and labour invested in reforestation. Consequently, if there is a significant risk of animal damage to your plantation then you need to consider taking protective measures during the reforestation process.

There have been many experiments to deter browsing: chemicals applied either on the foliage and through the roots (systemic), predator scents, and physical protection. At this time only a physical barrier is considered worthwhile. These can take the form of solid plastic cones (Sinocast), plastic mesh (Vexar), wire mesh (stucco wire) cages net tubes or plastic tubes.

Your choice will be determined by:

- cost and availability
- labour to apply, monitor and remove
- access to site
- type of browsing animal
- size of seedling during the susceptible stage
- wind or snow accumulation.

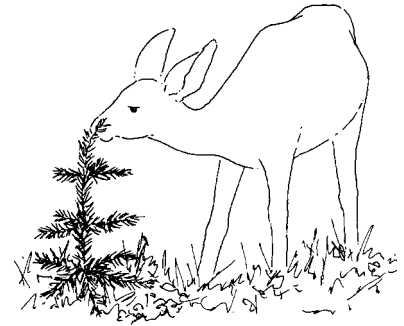

Wire cages, while possibly the most expensive initially, can offer the best protection, largest growing space and the ability to be re-used several times. Often one can purchase rolls of 'seconds' from a supplier at a lower cost.

Solid plastic tubes or shelters are quite popular as they make a 'greenhouse' type microclimate for the tree inside which results in faster initial growth. However, because the tree is supported by the cage it may not have developed adequate stem strength once the tube is removed making it more susceptible to wind and snow. Once the trees grow out the top, the cage often needs to be moved up.

Protection of Brush and Weed Competition

One last treatment you might consider before walking away from a planting project is the use of brush blankets or mulch mats to keep grass and weeds away from the newly planted seedlings. Grass and brush competition, especially for moisture during the dry summer and fall, can have significant and even crippling impacts on the growth of planted seedlings.

These fabrics are permeable to air and water, but suppress the growth of competing vegetation. They come in various sizes but the one meter square seems to be standard. Be inventive: use old paper feed sacks, dog food bags, or newspapers for small jobs. Do not use anything with plastic layers as this impermeability may cause localized drought or fungus build-up.



If you suspect that you will have to return to the site to undertake brushing and weeding, consider flagging or somehow marking the seedlings. This will assist productivity and preserve seedlings. Plastic or wire stake flag markers are available from most forestry supply dealers.

Recommended References

Small Woodlands Program of BC

A comprehensive 'Small Woodlands Library' is available on the web [www.swp.bc.ca]

BC Ministry of Forests

Silviculture Manual. 3 volumes. Silviculture Branch

Drag Scarification Handbook. Engineering Branch

Field Guides for the Identification and Interpretation of Ecosystem. Regional Offices

Provincial Seedling Stock Type Selection and Ordering Guidelines, ISBN 0-7726-3505-6

Nursery to Planting Site- A Team Effort brochure FRDA MOF

Minimum Safety Guidelines for Tree Planter, MOF Silviculture Branch FS419 1994

Putting People First—Minimizing Tree Planters Exposure to Seedling Pesticides

MOF Silviculture Branch FS 449 1994

Seed Zone Cross Reference Tables MOF

[www.for.goc.bc.ca/hfp/planting/tree.htm]

Oregon State University Forestry Extension

Seedling Care and Handling. EC 1095

Site Preparation: An Introduction for the Woodland Owner. EC 1188

Selecting and Buying Quality Seedlings. EC 1196

Booth, Ian and John Henigman, 1996. *Seedling Barrier Protection from Deer and Elk Browse*.

MOF Silviculture Branch, ISBN 0-7726-2787-8

BCFS/CFS, 1976. *Guidelines to Collecting Cones of B.C. Conifers*. Joint Report No.3

Turner, A., 1987. *The Treeplanter's Handbook*. Box 98, Mansons Landing, BC VOP 1KO

Forestry Undergraduate Society, 1983. *Forestry Handbook for B.C.*, U.B.C.

BC Teachers' Federation, 1979. *Forest Nursery Studies*. Lesson Aids

Lavender D. et al., 1990. *Regenerating British Columbia's Forests*. UBC Press

Preventing Tree Planting Injuries ISBN 0-7726-2870-X

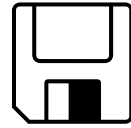

Stand Tending Basics

Stand Tending

In this chapter...

Why Cultivate Your Forest?	202
What Is Stand Tending?	202
Brush Control	204
Spacing and Thinning Treatments	208
Stand Management to Maintain Biodiversity	215
Fertilizing	217
Pruning	219
Recommended References	223
.....	

Why Cultivate Your Forest?

Like any crop, your trees need to be nurtured and cultivated in order to produce their best. A forest is like any other garden, and left alone it will grow to the limits of the available light, soil nutrients and water. It will potentially support a variety of plants seeding in from those already on the site as well as from seeds carried in by wind or dropped by birds and other animals using the area. Untended, it will grow according to nature's whim resulting stands according to your goals and needs.

By tending the forest you can select and shape the crops it produces. Stands are *tended* to improve the growth, quality and value of the trees on your woodland. As a woodland manager, you have some choice in the form your forest takes, including the species of trees, their size, distribution and even the rate at which they grow. Cultivating your forest is a way of shaping it to meet your management goals.

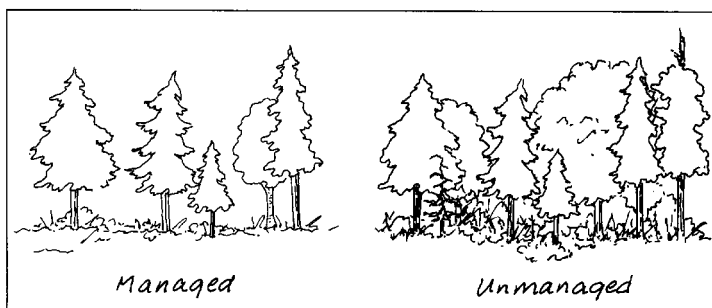

The practice of controlling forest establishment, composition and growth is known as silviculture. 'Silvi' is derived from the Latin word 'silva' which means a wood or forest, and 'culture' means cultivation.

What Is Stand Tending?

Stand tending is the process of modifying your woodland vegetation to improve tree growth and the quality and value of the timber products produced. By improving the vigour and health of stands, stand tending produces a merchantable crop of trees in a shorter time frame than if the stand were left to grow unmanaged.

Stand tending includes brushing, juvenile spacing, conifer release, thinning, sanitation cutting, fertilization and pruning, which are carried out at different phases in the growth cycle of a stand to improve timber value and production as well as to maintain biodiversity. You need to know the conditions under which treatment is desirable, the methods of treatment, and the effect each treatment has on the well-being and productivity of your woodland. It is not only a means of improving the value of the trees grown, but also of understanding the forces at work in your forest.

The objectives of stand tending are to:

- control the species composition of the stand to achieve landowner objectives from the site
- control the stand density throughout the life of the stand to achieve the greatest productivity
- maintain or enhance stand-level biodiversity and wildlife habitat
- reduce the losses to insects, disease and fire
- reduce the loss of merchantable trees that die from competition.

Your objectives may also include creating openings for forage production, improving access to your woodland, or improving its aesthetic appeal and property value.

When Do I Tend My Stand?

Stand tending can take place throughout the forest management. Stand tending treatments are designed to either speed up, stop or reverse the natural successional development of your woodland. This enables you to manage for a particular species, create a more valuable product, maintain biodiversity, enhance wildlife habitat or achieve your management goals (e.g., stand type, tree size) in a shorter time.

The stage at which these take place in a stand's life are shown in the following illustration. This chapter will focus on those activities that generally take place during the earlier stages of a stand's life including brushing, spacing, fertilization and pruning. Thinning is addressed in a separate chapter.

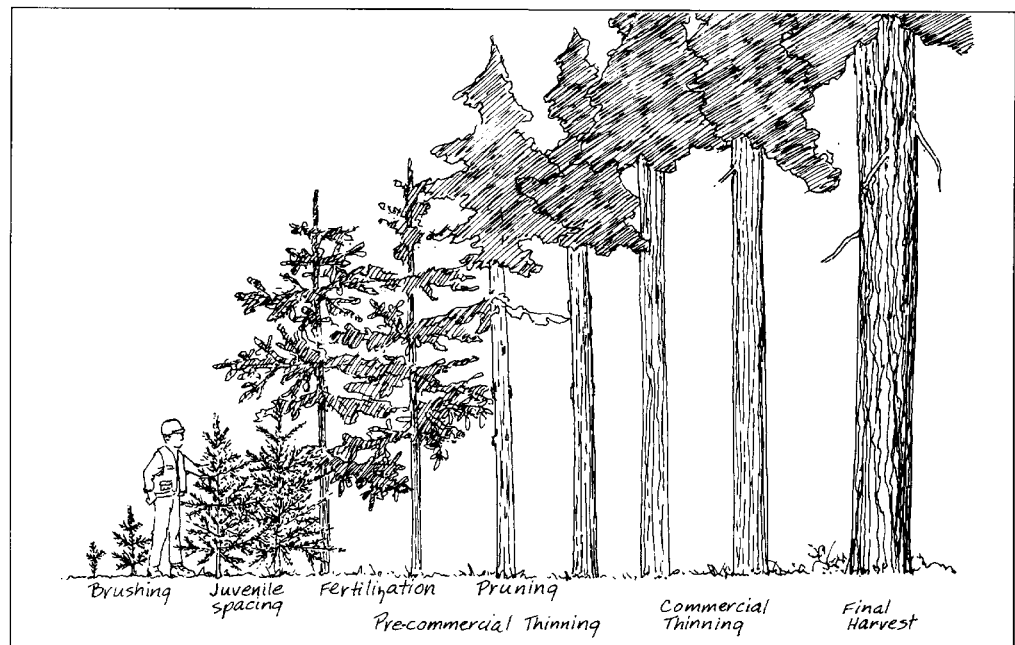

To develop a stand tending program for your woodland you should recognize when different treatments are needed to improve the growth and well-being of your stands. Evidence of stress and stagnation from competition in your stands can be important signposts to tell you when your trees need help.

Once you have identified the need for treatment, you must decide how to go about it. The appropriate timing and methods of individual stand tending activities will depend on the conditions within each stand and the fertility of each site. In general, it is good practice to rank your stand treatments to treat the best sites first, since these are the areas that have the greatest potential to respond. The exception to this rule is the fertilization of stands that are lacking in specific nutrients and whose growth is limited as a result.

In addition to the basic treatment information provided in the following sections, more detailed materials on specific treatments are available from the Ministry of Forests, Workers' Compensation Board, and other sources as indicated at the end of the chapter. Video materials on stand tending are available through Ministry of Forests and your local woodlot association or regional small woodlands library.

Brush Control

The first, and in some ways the most important stand treatment you may carry out, is 'brushing' to remove unwanted vegetation from the immediate area surrounding the seedlings (natural or planted). Competition at this early stage in the tree's life (2 to 5 years after regeneration) is a very real threat to survival and growth. By reducing the competition at the beginning of the crop cycle and increasing the available light, nutrients and water, you can help your crop trees become firmly established and get off to a productive start.

Your brush control strategy begins long before stands are harvested and the brush actually appears. Prior to logging, a silviculture assessment (called the silviculture prescription) is carried out to determine the appropriate silvicultural system by which the stand will be harvested, reforested and tended. The assessment predicts, among other things, the potential for brush on the area.

Sites that are 'good' for growing trees are also good for growing brush, and as a result, brush may be a particular problem on your better sites. Many brush species are shade-tolerant, so even silvicultural systems such as the shelterwood or selection methods that keep the forest floor partially shaded while regeneration

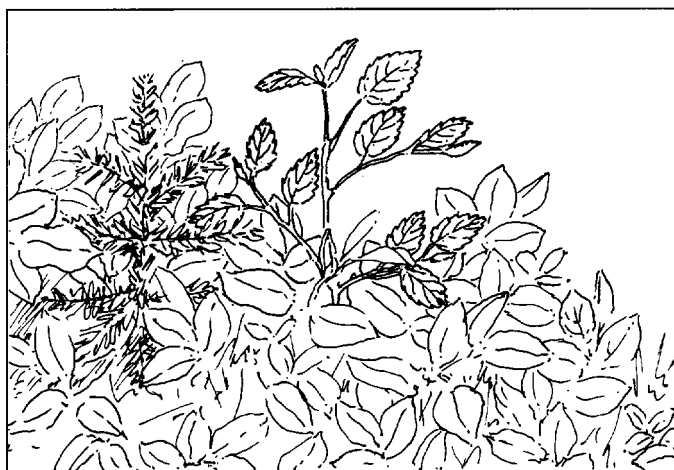

takes place, may not significantly reduce the level of brush competition. A combination of site preparation followed by the planting of large seedling stock is generally recommended for sites where extreme brush problems are anticipated.

In addition to your efforts to prevent brush problems before they arise, you should be prepared to carry out brushing if a problem develops. It is very important to treat your stands before brush competition starts to suppress seedling growth. Brushing can be carried out by a number of treatment methods including:

- manual techniques (hand cutting, pulling, girdling, covering brush saws, chainsaws)
- biological techniques (grazing)
- chemical techniques (careful use of herbicides through aerial, backpack or roadside spraying, or individual stem injection.
- mechanical techniques (site preparation or brushing using heavy equipment).

The selection of the best method for your woodland depends on site and stand conditions, as well as environmental factors.

In assessing the situation you must look at both the brush species and crop tree species. Consider such things as the rate at which the brush is growing and the maximum height it will reach versus the rate at which your seedlings are growing. What is crop tree's ability

to withstand competition? You should also consider whether there are enough seedlings to meet the stocking standards, or whether you should carry out whole site treatment such as site preparation and start the establishment phase (reforestation) over again.

Manual Brushing

Manual brushing is carried out with a variety of hand-held tools that retard the brush species by cutting or girdling their stems. Sandvik brush axes, brush hooks and machetes are effective for weeds and brush with stem diameters less than 3 cm; motorized brush cutters are used for stems less than 5 cm, and are particularly effective with salmonberry and other brush with clumped stems; and power saws are used for stem diameters greater than 5 cm.

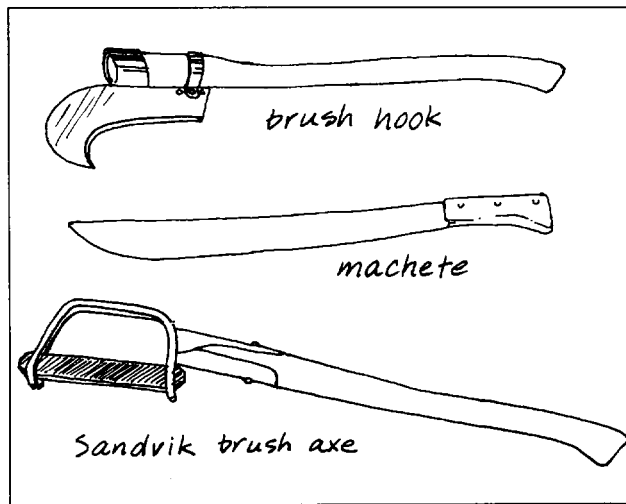

Manual brushing is often selected for sensitive sites, such as streamsides or recreation areas, or when brush is a problem only in specific pockets of the woodland. It is usually done during the spring or summer months when the brush species are most sensitive to treatment.

Manual brushing is labour-intensive and can be expensive, if you have a large area or need to repeat brushing treatments. Remember that brush species are pioneer plants whose successional role is to quickly

and extensively occupy sites that have been cleared of vegetation. These plants and shrubs are hardy and though you may kill off one year's growth or even individual plants, they are capable of sprouting, seeding, and re-establishing themselves on a site within a short period of time. In fact, in species such as willow, alder, maple and cottonwood which easily resprout many shoots from a single cut stem, manual brushing methods can make a brush problem worse. In such situations, the injection of a herbicide is often the only means of killing the plant in one treatment. If you have only a few stems to control, consider covering the stump with black plastic.

Biological Brushing (Grazing)

In some areas of the province, the grazing of sheep is routinely used as a means of brush control and can be very effective. The keys to success include:

- choosing the right site: one that is suitable to sheep grazing and has suitable forage, a slight to moderate slopes, minimal debris and a low threat of predators.
- selecting the right sheep for the job and an experienced shepherd.
- timing: proper timing is crucial to a successful grazing project, the target vegetation must be palatable and in sufficient quantity. Grazing should normally not take place during bud burst when the new foliage on the seedlings is most appetizing and susceptible to breakage.

During grazing animals should be moved frequently to avoid over grazing and increased seedling damage from browse damage and/or trampling. The smaller and weaker the seedling, the more vulnerable it is. For this reason, grazing should be delayed until three or four years after planting, when the seedlings are large enough to be seen (and hopefully avoided) and more able to withstand damage.

If using grazing as a brush control technique you must also consider:

- wildlife concerns, either through displacement or predator conflict
- the potential for water contamination if livestock are allowed direct access to streams and lakes
- the potential for soil erosion, compaction or displacement due to overcrowding too many animals into one area for an extended period of time
- the potential transfer of undesirable plant species to forest sites.

Chemical Brushing

Where brush is widespread or persistent, herbicides are often chosen as the most effective control method. Herbicides are commonly applied by air or ground. The ground methods include:

- foliar spraying back-pack or vehicle-mounted sprayers with hand-held nozzles)
- cut-surface application of herbicide to individual trees by injection (e.g., hack and squirt), or to the surface of freshly-cut stumps)
- soil application of granular or pellet herbicides over the root systems of target brush species
- basal spraying.

The use of forest herbicides is strictly regulated by the *Pesticide Control Act* which sets out provisions for all pesticides in the province, including insecticides (for insect control) and herbicides (for vegetation control). A Pesticide Use Permit

must be obtained from the Provincial Pesticide Control Branch of the Ministry of Water, Land and Air Protection for the use of herbicides on both private and public lands used for forestry. The district manager of the Ministry of Forests must also be provided with written notice of the proposed herbicide use. Although First Nations are not required to obtain this permit for Reserve lands, it is strongly recommended they follow the same procedures of obtaining a permit and notifying the Ministry of Forests.

To apply or supervise the application of a forest herbicide on Crown or private forest lands you must hold a valid Forest Pesticide Applicator Certificate, which is obtained

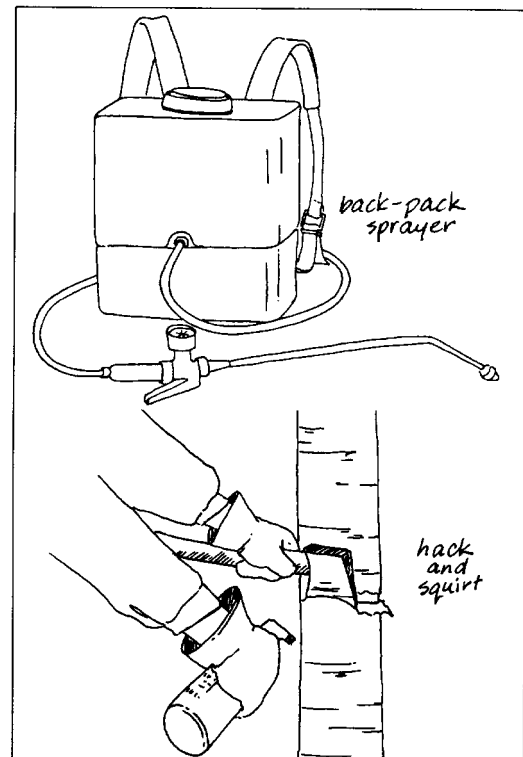

after completion of a course administered by the Ministry Forests and passing the examination set by the Pesticide Control Branch.

Since herbicides are designed to act in specific ways (on foliage or roots) on specific species of brush, the timing and rate of application is critical to treatment effectiveness. It is very important that careful consideration be given to the choice of herbicide and the method and timing of application. Relatively few herbicides are available for forest use and registration changes from time to time, so you are advised to check with local silviculturists as well as the district office of the Ministry of Forests when you are considering herbicide application.

Brush Control Considerations			
<i>Method</i>	<i>Application</i>	<i>Advantages</i>	<i>Disadvantages</i>
Manual	<ul style="list-style-type: none"> – sensitive areas – spring/summer – spot problems 	<ul style="list-style-type: none"> – all terrain – little site disturbance 	<ul style="list-style-type: none"> – labour-intensive (costly) – potential for worker injuries – roots are not killed, often need to repeat treatment – not appropriate for heavy brush conditions
Mechanical	<ul style="list-style-type: none"> – site preparation 	<ul style="list-style-type: none"> – fast 	<ul style="list-style-type: none"> – not for slopes > 35% – whole site treatment
Biological (Grazing)	<ul style="list-style-type: none"> – before bud burst and after bud set 	<ul style="list-style-type: none"> – integrated use – fertilization 	<ul style="list-style-type: none"> – potential damage to conifers by trampling, browsing – limited effect on other resources – fencing costs – only suitable on sites with forage
Chemical	<ul style="list-style-type: none"> – summer (sprayed on foliage) – injection (year round) 	<ul style="list-style-type: none"> – species-specific – little site disturbance – seedling exposure to sunlight is gradual – inexpensive – controls resprouting (as above) – treatment is species-specific 	<ul style="list-style-type: none"> – public concern – few registered herbicides – some species of vegetation are resistant – weather constraints (as above) – labour intensive

In choosing the method of brush control for your stands, you should consider:

- *Your treatment objectives:*
for example, complete control, to increase light to understorey conifers, decrease competition for moisture
- *Your site constraints:*
for example, slope, accessibility, streamside
- What species you want to remove and where they are located:
in trouble spots, sensitive areas, or everywhere

- *Cost alternatives:*
especially labour, if not doing the work yourself
- *Other management considerations:* for example, domestic stock, wildlife and fish habitat, recreation and watershed values.

Your decision should be made on an area-specific basis considering the potential for damage to crop trees and the other resource values, including the environment.

Brush Control Guidelines:

- anticipate brush problems when planning harvesting and reforestation
- treat the best sites (with highest competition) first
- identify target brush species and their locations
- determine alternative means of control
- choose best method for your site and goals
- use equipment and chemicals safely
- obtain a Pesticide Use Permit if using forest herbicides

Mechanical Brushing

Mechanical brushing methods are most commonly used during site preparation to remove brush prior to regeneration. Heavy equipment such as excavators (hoes), tractors or skidders are mounted with special plows or cutters to clear brush and prepare the seedbed (see the chapter on reforestation for more information on site preparation).

Spacing and Thinning Treatments

Spacing and thinning treatments alter the stand density by reducing the number of stems per hectare growing on the woodland. They are carried out to:

- focus the growing potential of the site on the trees most capable of responding (your crop trees)
- to create certain stand conditions (light levels), that favor certain understorey species for forage for wildlife, livestock or botanical forest products
- modify species composition
- remove undesirable species or damaged or diseased trees.

Thinning treatments can be done at many stages in the development of a stand. It is given different names depending on the characteristics of the material it removes. The first thinning treatment is usually called *juvenile spacing* since it removes very young stems. This treatment is also referred to as *pre-commercial thinning* since the stems removed have traditionally been too small to be sold as a commercial crop by the large industrial operators. *Commercial thinnings* are carried out later in the life of the stand, and remove stems large enough to be sold as sawlogs or other commercial products.

Often included in juvenile spacing activities is *sanitation thinning*, which involves the removal of overtopping diseased or defective stems (such as those infected with dwarf mistletoe); and improvement cutting, which removes poorly formed, or otherwise undesirable deciduous and coniferous stems.

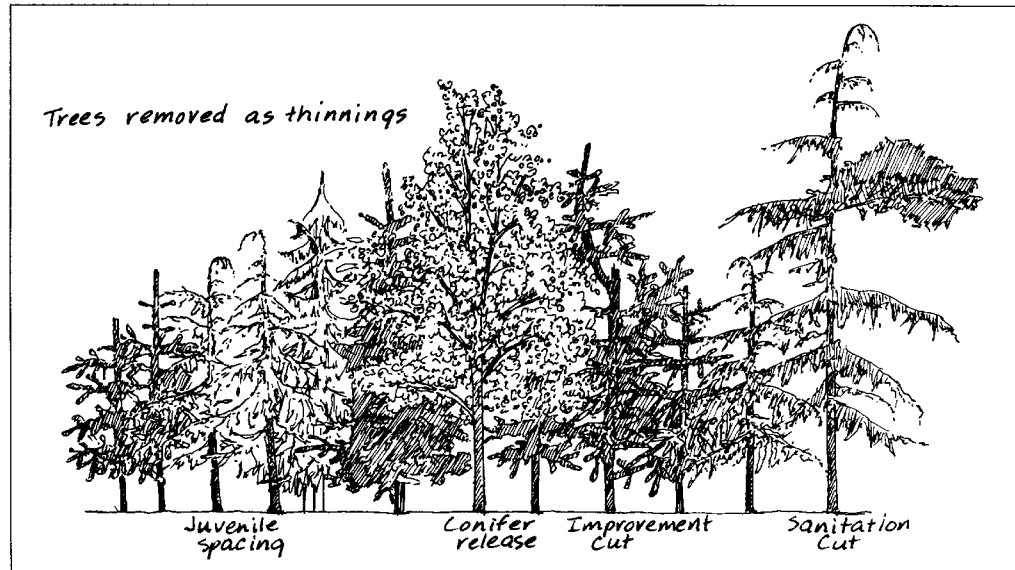

Conifer release is another thinning treatment, that focuses on the removal of deciduous tree species that are overtopping and suppressing the growth of more valuable conifers. In many ways it is similar to brushing since it removes species such as alder, maple, aspen and other less desirable deciduous species. Conifer release is often carried out in conjunction with juvenile spacing so that the deciduous species are removed while the young conifers are being thinned. It is commonly carried out by the injection of herbicides, or by stem girdling. Both these methods result in slow release (i.e., gradual exposure of the conifers to sunlight) as the deciduous trees die over 1–2 seasons.

Although each of these thinning treatments has a special objective, they are all done to improve the growing conditions of the stand and the value of the products eventually produced from it.

The Benefits of Thinning

The volume of wood capable of being produced in any given stand is fairly constant, based on the capability of the site to produce particular species of trees. When some trees are removed, the resources of the site are channeled onto the trees that remain. This has two advantages. It enables the preferred trees to ‘capture’ the growth potential that would otherwise have been ‘wasted’ on trees that would eventually have died from overcrowding. At the same time, it accelerates the natural process of stand development and enables you to produce your future crop trees to a merchantable harvest size in a much

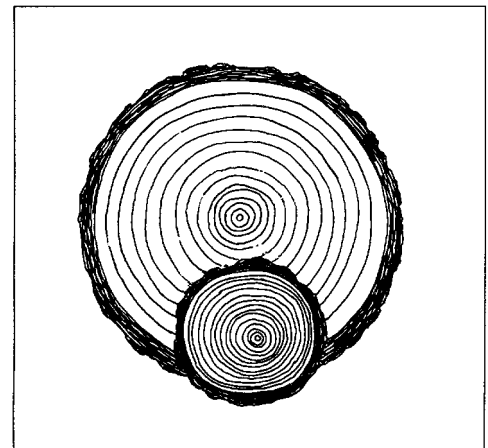

shorter time period. In some cases 75% or even less of the time it would take to produce similar-sized trees in an unmanaged stand!

The benefits to be achieved by juvenile spacing and other thinning treatments include:

- shortening rotation by speeding up growth of crop trees
- increasing merchantable volume by concentrating growth on fewer stems
- producing more favourable end-products by controlling the species and stem form
- reducing losses to windthrow and snowpress by
- increasing individual stem stability
- improving the overall health of the stand and protecting it from disease and insects by the selective removal of diseased or defective stems
- reducing future logging costs by creating a more uniform and larger piece size.

Note: That 'bigger' is not always better and that density management should also consider your wood quality goals. For instance, giving your trees too much space also can lead to more and longer branches increasing knot size and/or requiring additional pruning costs. Ring density is also often a factor affecting the grade and value of a log. If the ring density is too low the log may not achieve its best potential value. Therefore, size, volume and ring density can be a trade off and density management should consider these factors.

In developing a juvenile spacing regime for your woodland, you will need to consider a number of factors, including how many trees to remove, which ones and when. Site and stand conditions, the potential markets for small wood products, the number of thinning treatments, as well as the desired end-product, all affect the choice of the number of stems to retain at each phase.

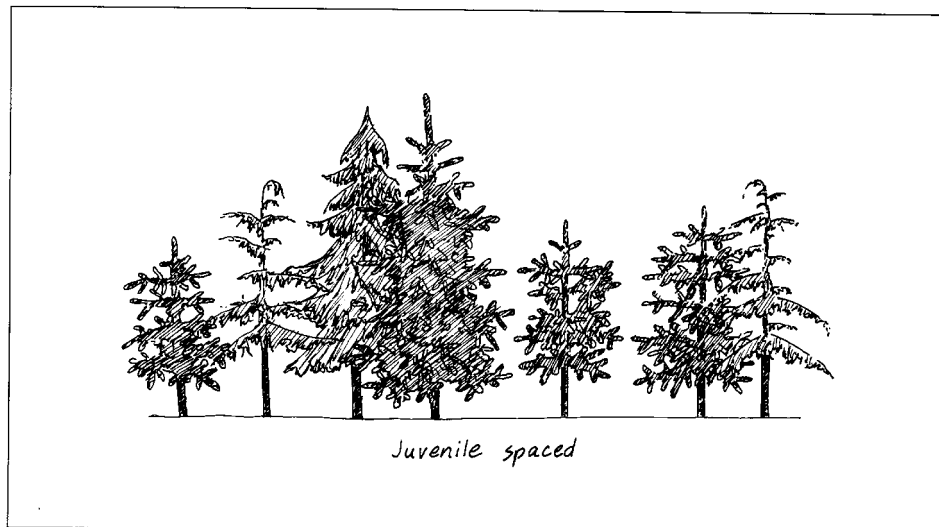

Planning for Juvenile Spacing

At the time of regeneration, most planted stands contain 800 to 2000 seedlings per hectare, and natural stands may range up to 25 000 seedlings. The stocking of young stands is often dense and uneven in the early years of a rotation as seeding-in continues and young trees search for a foothold.

By the time the trees are 10 to 20 years old and between 3 and 5 metres in height, their crowns and root systems will usually start to crowd each other. When the crowns of neighbouring trees touch and start to block the entry of sunlight to the forest floor, this indicates that the trees are filling the available growing space and have begun to encroach on each other's territory. If left, this situation will result in a slowdown in growth. As light below the main canopy is blocked out, the foliage on lower branches will begin to die, and the live crown will appear to 'shrink' and recede up the tree. Juvenile spacing should be carried out just before the live crowns start to recede. The purpose of juvenile spacing is to organize the growing space in the stand by removing unwanted or excess stems. It creates growing room for those species most capable of productive growth on each 'microsite' created by the terrain features on your woodland (such as rock outcrops or moist depressions).

The selection of stands for juvenile spacing and the timing of treatment will depend on the characteristics of the stand and your management objectives. Some guidelines for the selection of stands include:

- dense stands
- shade-intolerant species
- evidence of receding live crowns
- stands where competition is greatest and dominance has not yet been established
- healthy stands, not susceptible to blowdown
- stands with high response potential (best sites, trees 15–25 years old).

In general, juvenile spacing enhances most management objectives by improving access for both people and wildlife, improving stand vigour and reducing the hazards related to fire and pests over the life of the stand.

In the short-term however, be aware that juvenile spacing can present a fire hazard to your stand. The spaced material should be laid flat on the ground to facilitate decomposition more rapidly or pulled to cleared areas, such as



roadways, for burning or chipping. Particular care should be taken to remove slash from roadsides where sparks or untended cigarettes are a potential danger. As an alternative, you may consider leaving an untreated buffer strip along roads in stands where juvenile spacing is being carried out. An untreated buffer strip also provides better cover for wildlife within the stand.

Juvenile spacing can create an immense amount of slash. This can often interfere with wildlife migration and travel routes and can make it difficult to access parts of the block in case of emergency. Workers' Compensation Board *requires* the establishment of evacuation routes throughout the work area.

Juvenile Spacing Considerations			
Method	Application (stem dia. @ ground)	Advantages	Disadvantages
Power Saw	>4 cm	<ul style="list-style-type: none"> – tree selection easy to see; spacing interval easy to control 	<ul style="list-style-type: none"> – dangerous work – machine repairs
Brush Saw	<10 cm	<ul style="list-style-type: none"> – tree selection easy to see; spacing interval easy to control – safer than power saw, production 2–4× faster – fewer repairs to equipment 	<ul style="list-style-type: none"> – terrain, 40% – difficult to move in heavy slash – limited to dia. <10 cm – operator training takes 6 months
Pruning Shears	<4 cm	<ul style="list-style-type: none"> – tree selection easy to see; spacing interval easy to control – easy to train operator – safe for operator – equipment repairs minor and costs low 	<ul style="list-style-type: none"> – large trees difficult to cut – shears wear out – probable ingrowth after treatment – dominance not yet established (so natural crop trees not identified)
Hand Pulling	<ul style="list-style-type: none"> <3 cm – trees must be able to be pulled with minimum effort 	<ul style="list-style-type: none"> – tree selection easy to see – easy to train – safe for operator – no equipment 	<ul style="list-style-type: none"> – constantly bending tires worker – limited to small trees – probable ingrowth after treatment – dominance not yet established
Chemical	>6 cm	<ul style="list-style-type: none"> – cheapest method with trained crew – slash minimal – equipment easy to maintain – no terrain limitation – safe for operator 	<ul style="list-style-type: none"> – use of chemicals around water/wildlife – operator training takes 6–8 months – cannot see spacing interval, so poor quality control – release and response are slower than when trees are physically removed – provides fuel ladder into crowns of crop trees
Mechanical	<ul style="list-style-type: none"> – where no tree selection is required – applied as kill and leave strips – single species, even-aged, healthy stands – minimal slash conditions – stumps <30 cm; slopes <65% 	<ul style="list-style-type: none"> – high productivity – slash is compacted – low fire hazard 	<ul style="list-style-type: none"> – machine costs high – no tree selection – potential for damage to trees in ‘leave strips’ – potential for trees in ‘kill strips’ to be badly damaged but not killed

Spacing Guidelines

Where juvenile spacing is carried out by power saws or brush saws, stems should be cut according to the following guidelines:

- trees should be cut as close to the ground as possible; stumps less than 30 cm
- cuts should be made below the lowest live branches; where this is not possible due to slash or terrain, all live branches should be cut off the stump to prevent them from becoming replacement main stems
- cut angles should be parallel to the ground
- all stems cut cleanly (i.e., no hinges)
- all damaged (accidentally or otherwise) trees must be cut
- trees should be felled to avoid damage to crop trees
- cut material should be laid flat to the ground
- all conifers (other than crop trees) taller than 1 m must be cut
- cut back all woody vegetation within 1 m of crop trees
- reduce spacing by 50% around natural openings, old skid trails and roads
- do not leave cut trees “hung up” in crop trees.

For more specific details on juvenile spacing you are referred to the ‘Juvenile Spacing’ pamphlet produced by the Ministry of Forests and the ‘Juvenile Spacing Manual’ produced by the Workers’ Compensation Board.

Selecting Your Crop Trees

The most important decision you will make in juvenile spacing is the selection of crop trees, since it is on these trees that all your future treatments will be focused and your returns will depend.

When selecting your crop trees, keep in mind that your goal is to concentrate the growth potential of your site on those stems throughout the rotation period. Crop trees should be of the species best-suited to the growing environments in your stand. They should be dominant or co-dominant trees of good form, free from physical defects, insects or disease. They should have straight trunks without forks or crooks, full crowns of good colour with vigorous leader growth. Branches should be horizontal or down sloping to shed snow, and small in diameter (smaller knots mean higher grade wood products). The crop trees must be windfirm. In short, they must be the best trees in your stand.

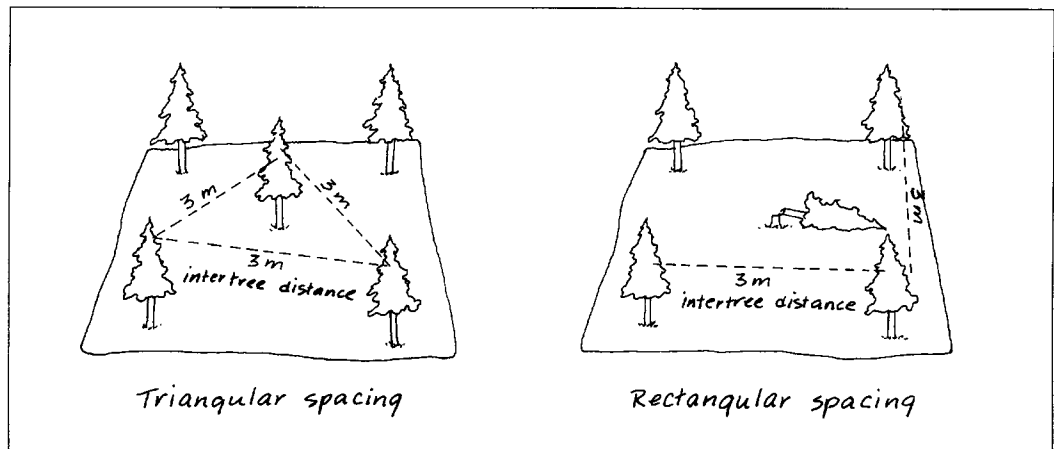

Once crop trees have been identified, the stand is spaced to provide growing room for these trees. Spacing is carried out according to the desired distance to be left between the crowns of those trees remaining, known as the 'intertree distance.' This can be measured in two ways: as rectangular spacing, where the trees are in defined rows and at regular intervals (such as in plantations), or as triangular spacing of direct tree to tree distances.

The same 3 m × 3 m spacing interval will leave you with 1100 trees per hectare when carried out as rectangular spacing, but with 1300 trees per hectare when carried out as triangular spacing—a difference of 15%. Be sure to check which type of spacing is meant in any spacing guidelines you follow. The intertree distances that are referred to in the rest of this chapter will be based on rectangular spacing.

Determining Spacing Interval

To determine the desired spacing interval for a stand, the following factors are considered:

1. Crown Width and Length:

Leave enough room between trees to maintain approximately 70% live crown until either commercial thinning or final harvest.

2. Species:

The more shade-intolerant the species, the wider the spacing interval.

3. Site Quality:

Higher quality sites will support greater densities of stems without stagnation.

4. Site Moisture Regime:

Drier sites require lower stand densities; root space and moisture become the key limiting factors rather than crown space and light.

5. Anticipated Future Mortality:

where a certain amount of stem death is anticipated due to forest pests, fire or other causes, you may adopt a more conservative, closer spacing.

6. Management Objectives:

The desired end-products (ring density, knots, piece size) and anticipated future treatments will influence the spacing interval, as will other management objectives, such as forage production.

7. Abiotic Damaging Factors:

If you are in an area that receives heavy wet snowfall, consider how much the trees help support each other. Too wide of an inter-tree distance may cause extensive breakage. You may have to make more than one juvenile spacing entry.

Some examples of spacing intervals for different management objectives are given below. Forage can be produced in the more open spacing densities, especially in the spacing of lodgepole pine for sawlogs.

Note: Crop tree selection takes priority over spacing interval so always leave the best quality, fastest growing trees on-site, and favour the species most suited to the growing conditions.

The following table presents some general provincial ranges for juvenile spacing. The first, smaller number is the suggested spacing interval for stands in which a second pre-commercial or marginally commercial thinning will be carried out, or where substantial kill from insects or disease or other factors is anticipated. The second, larger number is

the wider spacing interval suggested in stands which will not be spaced again prior to commercial thinning or early final harvest for small wood products.

Juvenile Spacing Ranges		
<i>Species</i>	<i>Triangular Intertree Spacing (m)</i>	<i>Stems/ha</i>
<i>Coast</i>		
hybrid poplar	2.69–3.4	1600–1100
Douglas-fir	2.98–3.8	1400–800
western hemlock	2.69–3.8	1600–800
red alder	2.69–3.8	1600–800
back cottonwood	2.98–3.8	1400–800
<i>Interior</i>		
lodgepole pine	2.53–3.8	1800–800
ponderosa pine	3.4–4.39	1100–600
Douglas-fir	3.4–4.39	1100–600
western larch	3.4–4.39	1100–600
spruce	3.4–4.39	1100–600
subalpine fir	3.4–4.39	1100–600
balsam poplar	2.69–3.24	1600–1200
interior cottonwood/birch	2.4–3.8	2000–800

Juvenile spacing prescriptions vary greatly throughout the province according to stand and site conditions, management philosophy, and forest management objectives. The Ministry of Forests has developed regional guidelines to provide more specific direction to spacing intervals for the major commercial species. For more information, check with your district office.

Stand Management to Maintain Biodiversity

Wildlife trees, variability in the vertical and horizontal structure of the stand, and maintenance of native tree composition are important features to address when planning for stand level biodiversity in a brushing, spacing or thinning operation. The following figure shows an example of a spaced stand with biodiversity attributes maintained.

In general you should try to maintain the following features:

- non-competing trees
- wildlife trees (standing dead or live trees with special characteristics that provide valuable habitat for conservation or enhancement of wildlife)
- maintain a variety of stocking levels that will provide for vertical and structural diversity of the stand.
- maintain diversity of native tree composition: a stand with several tree species will tend to support more species of animals than a stand with only one tree species, where possible maintain the full range of native conifer and hardwood tree species originally found in the stand)

- maintain understorey species composition—understorey shrubs such as willow and elderberry provide forage for deer and moose, particularly in winter. Berry producing shrubs provide important forage for bears, some songbirds, and small mammals. Shrubs can also provide shelter for a variety of birds, snowshoe hare, squirrels, chipmunks, and other small mammals. The full range of native understorey plants and plant communities should be maintained across the landscape unit.
- maintain untreated buffers along special habitats such as riparian areas, nesting or calving areas and along roadsides to screen wildlife from view.
- keep existing wildlife or recreation trails free of slash.

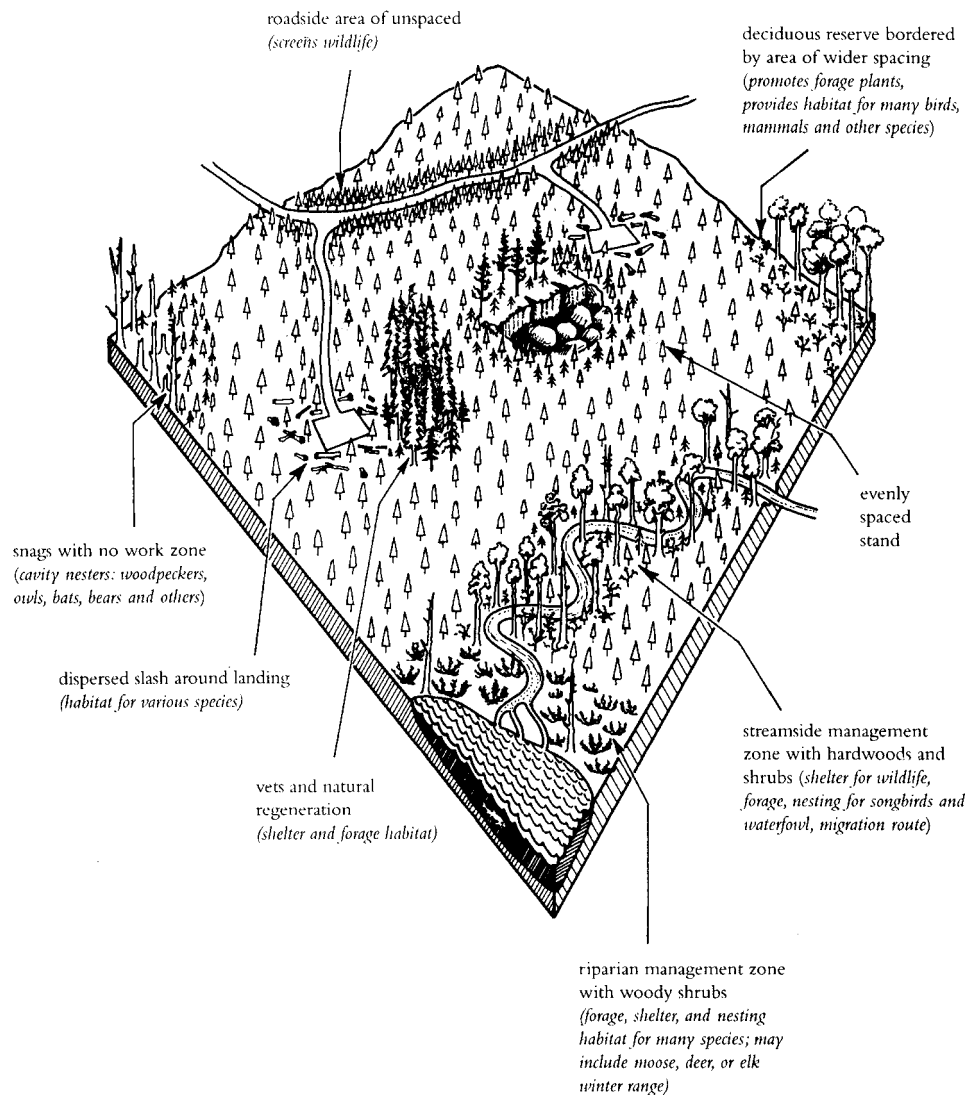

Fertilizing

Just like people, trees require a balanced diet to grow well. While most stand improvement treatments focus on maintaining a continuous and adequate supply of light as well as water and soil nutrients to the crop trees, there are also instances where trees require additional nutrients to those available on-site.

Nitrogen (N), phosphorus (P), potassium (K) and sulphur (S) are the most common elements applied to forest stands. Two common nitrogen fertilizers are urea pellets and ammonium nitrate crystals, both of which can be spread by hand (over small areas) with a garden variety 'cyclone seeder.'

Another means of increasing the level of nitrogen in the soil is through the presence of alder, lupins or legumes on the site. These plants have a special relationship with bacteria that live in nodules on their roots that are able to capture nitrogen from the air. In return for carbohydrates (energy) from the tree, the bacteria feed nitrogen into the plant's system through the roots. When the plant's leaves fall, this nitrogen is carried back to the soil, enriching the site for all plants growing there. The undersowing of clover the growing of alder in mixed stands with Douglas-fir and the sowing of lupins under pine stands in the interior are being tested experimentally, as a means of increasing the level of available nitrogen. A word of caution however: alder may be difficult to control once it becomes established and could create a brush control problem (shading out) for young conifer stands.

Foliar Analysis

To determine whether or not fertilizer is needed, a chemical analysis is usually carried out on the foliage of trees from the areas in question. Foliar analysis can be done quite inexpensively at a number of laboratories throughout the province. Check with your local

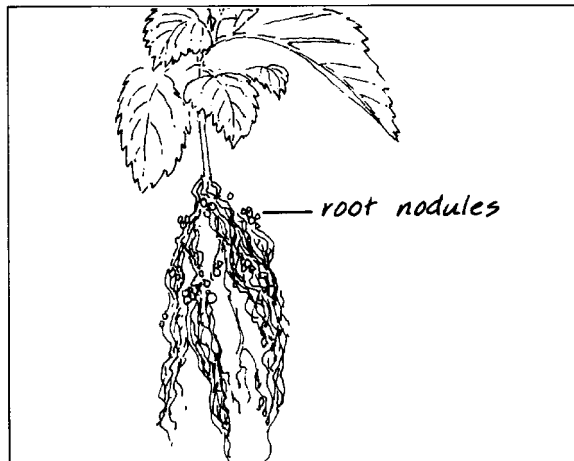

district office for advice on where to send your samples, then check with the laboratory to make sure that you can obtain an interpretation of the results along with the analysis.

In preparation for foliage analysis you will need to map out the sites on your woodland according to the forest cover and site class. For each site to be analyzed you will need to collect a different set of samples, so you may wish to only do one site at a time.

Foliage samples should be collected according to the following guidelines and placed in a plastic bag for shipping. It is also a good idea to send along a brief description of the area, the age and species mix of the stand, stocking density, stand history and any other treatments carried out to date, as background for the analysis.

Avoid sampling trees that:

- have a heavy cone crop (often an indication of stress)
- have insect or disease damage
- are near dirt or gravel roads (dust can contaminate the analysis).

Also, try to handle the samples as little as possible; grease, food and other materials can ruin the test results.

For each site:

- collect samples from 15 representative trees (all samples in one bag)
- take samples of last year's needles from two branches on each side of the tree (just a small snip—about 15 cm or 6" from each)
- collect samples during the dormant season (e.g., Sept.15–Apr 1 in the interior; Oct.–Feb. on the coast)
- collect samples only from the tallest (dominant and co-dominant) trees
- collect samples from the upper third of the crown but not from the leader or top two whorls of branches
- if foliage is very wet, air dry it prior to shipping; or ship as quickly as possible after collecting

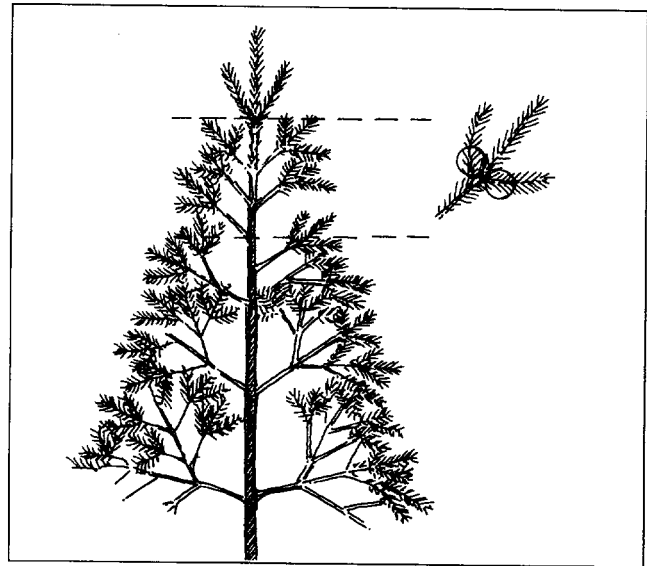

The analysis will provide the status of the nutrients in the trees, and indicate whether the stand could be expected to respond to fertilization.

Screening Trials

If you wish to know the degree of potential response—which is important information to help you determine whether the response will be worth the cost of fertilization—you will need to carry out a 'screening trial.'

A screening trial will take one year. It is done by establishing a number of sample plots (perhaps five plots of two trees each) on the site type being analyzed. Two foliar samples, collected a year apart, are taken from these plots. The first samples are collected in the fall of the first year and are sent for foliar analysis. The recommended fertilizer is applied in the spring of the next year and the second set of foliage samples is taken in the fall.

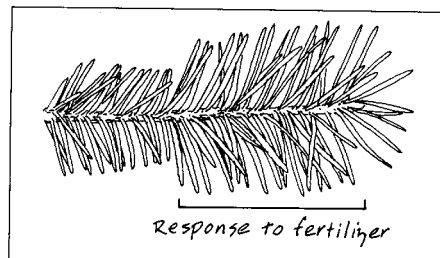

The needles of the samples are weighed to find out if there has been an increase in growth in response to the fertilizer. The second foliar analysis will show any change in the nutrient

status of the trees since the fertilizer was applied. Together, these provide an indication of the amount of fertilizer taken up and the potential response to that fertilizer by the trees on these sites. Although it is not possible to precisely project the amount by which individual stands will respond, this procedure can give you a good idea of which stands will likely respond best. This will help you to determine whether the treatment would be worth while, and to rank which stands are most important to fertilize.

The response to fertilization varies from species to species and stand to stand, and appears also to be affected by the age of the tree at the time of treatment. In general, the response to fertilizer is greatest in the first two to four years following application, and lasts from seven to ten years. The effect of fertilization is influenced by the tree's ability to absorb it from the soil, so factors such as soil moisture, size of tree crown and root system are important variables in fertilizer response. For this reason, fertilization is usually carried out only in spaced or open-grown stands. Likewise, fertilizer is applied in early spring or late autumn when the weather is cool and rain is likely, since the fertilizer needs to be dissolved in order to be taken up by the tree.

In British Columbia, most of the research into forest tree fertilization has focused on the response of coastal Douglas-fir to nitrogen. Nitrogen is commonly applied as forest grade urea fertilizer, which is made up of approximately 46% nitrogen. To meet the treatment level of 200 kg of nitrogen per hectare, the application of 435 kg of fertilizer would be required. Obviously, this would be an unmanageable task by hand, so forest fertilizer is applied most often by helicopter. However, on smaller areas, hand application using a cyclone seeder can be cost effective.

If you are considering fertilization, it is likely that others in your area are too. It may be worthwhile to organize a cooperative venture through your local Woodland Association. Also contact your Forest District Office to see if there is a fertilization program for Crown lands in your area. If the helicopter and fertilizer spreading equipment are already nearby you may be able to reduce the set-up costs of fertilization.

Pruning

Pruning refers to the removal of live or dead branches from trees and is carried out for a variety of management objectives.

- To produce clear, knot-free timber for high value sawlogs or veneer. Knots formed by wood growing around branches and branch stubs reduce the value of the wood when it is milled for lumber or plywood. Pruning is carried out to remove the lower branches of the tree, and promote the formation of clear wood in this area of the trunk as the tree grows.
- To control the spread of pests such as the white pine blister rust which enters the tree through the needles of lower branches.
- As a fuel management practice to remove branches that can act as fuel ladders and carry ground fires up into the crowns of trees.

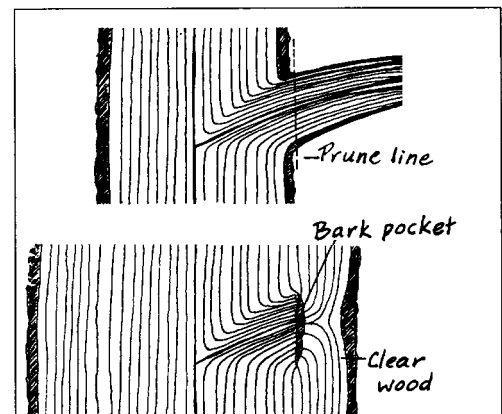

In British Columbia, pruning has been largely a coastal stand tending treatment to this point in time, though it is being tried on an experimental basis in some wet belt stands in the interior.

Ideally, pruning should be started when trees are about 10 cm (dbh) and 4 to 5 metres tall. The first pruning or 'lift' should be to a height of 2.5 metres, or the length of one peeler log. It can usually be done with a saw or pruning shears. Further pruning may be done to a height of 6 metres (two log lengths plus an allowance for stump and trim), preferably in two lifts to minimize the diameter of the knotty core, and will likely require a long-poled saw or shears and a ladder

The amount of live crown to be retained after pruning varies with the species. As a guideline, two thirds the total height of the tree should be retained in live crown for species such as Douglas-fir, larch, spruce and hemlock; and one half of the total height for pine species. Remember that the living branches, or crown, of the tree are its food production system. Removing too many of the branches will limit the tree's ability to produce food and thereby reduce its growth and vigour.

Pruning is best carried out in cold weather, when growth is minimal or the tree is dormant. A small toothed pruning saw or pruning shears are recommended. For branches larger than 10 cm in diameter it may be necessary to cut in two steps, starting with an undercut, to prevent the bark from ripping below the branch as the second,

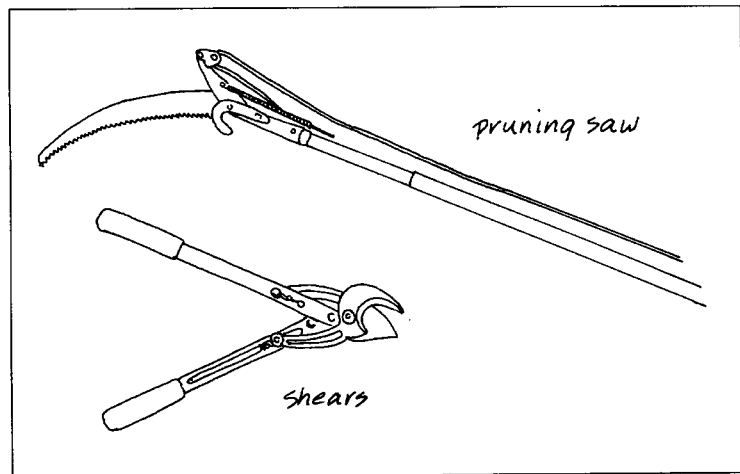

top cut is made. Branches should be pruned as close as possible to the main stem without causing damage. If a branch stub is left, it will commonly result in a delay in the formation of clear wood as it may take two to five years for the stub to heal over. In general, all dead branches (without needles or leaves) should be removed as they will produce loose knots if left on the tree.

It takes many years to achieve the improvements in wood quality that result from pruning. In general, the potential returns from pruning are related to final tree size. Pruning should be carried out on young trees, early in the rotation, so that a maximum of clear wood can be gained as the trees grow.

Pruning Guidelines:

- prune only stands of fast-growing, good quality trees of the preferred species (e.g., Douglas-fir on the coast)
- prune the best dominant and codominant trees (straight stem, unscarred, single top)
- avoid excessively branchy trees
- prune trees early in the rotation (to maximize the amount of clear wood that can be added during the growing cycle ideally around 10 cm diameter or less)
- prune a minimum log length (6 m) in two or three stages, making sure that 2/3 to 1/2 of the tree remains in live crown, depending on the species
- prune in the dormant season (fall/winter).

Pruning is recommended only in conjunction with a thinning program in order to maximize the growth of the pruned trees, and the production of high-value wood. The removal of live crown will slow the growth of pruned trees for a few years, and if unpruned trees are left on-site they have the potential growth advantage over the pruned crop trees. In situations where thinning is not carried out, it is possible that unpruned trees could actually overtop and suppress the crop trees,

Before pruning, it is a good idea to obtain a professional opinion on the potential for increasing tree value that pruning could achieve in a particular stand. For many woodland operators, pruning is an enjoyable activity that produces many benefits in addition to the production of clear wood, including the provision of clearance for horseback, cross-country ski and mountain bike trails.

What Returns Can I Expect?

Stand tending is an important part of woodland management, providing not only financial rewards but also aesthetic, protection, recreation and other benefits to the woodland owner. The response to each treatment will vary according to the site, species and the tree's age and condition at the time of treatment. In general, the response to stand improvement treatments will be better on your better sites.

By reducing the demand for light and water in a stand, thinning treatments effectively increase the supply of these essential ingredients to the crop trees. As a result, these trees can achieve remarkable increases in growth. Fertilization in specific situations can boost this growth even more.

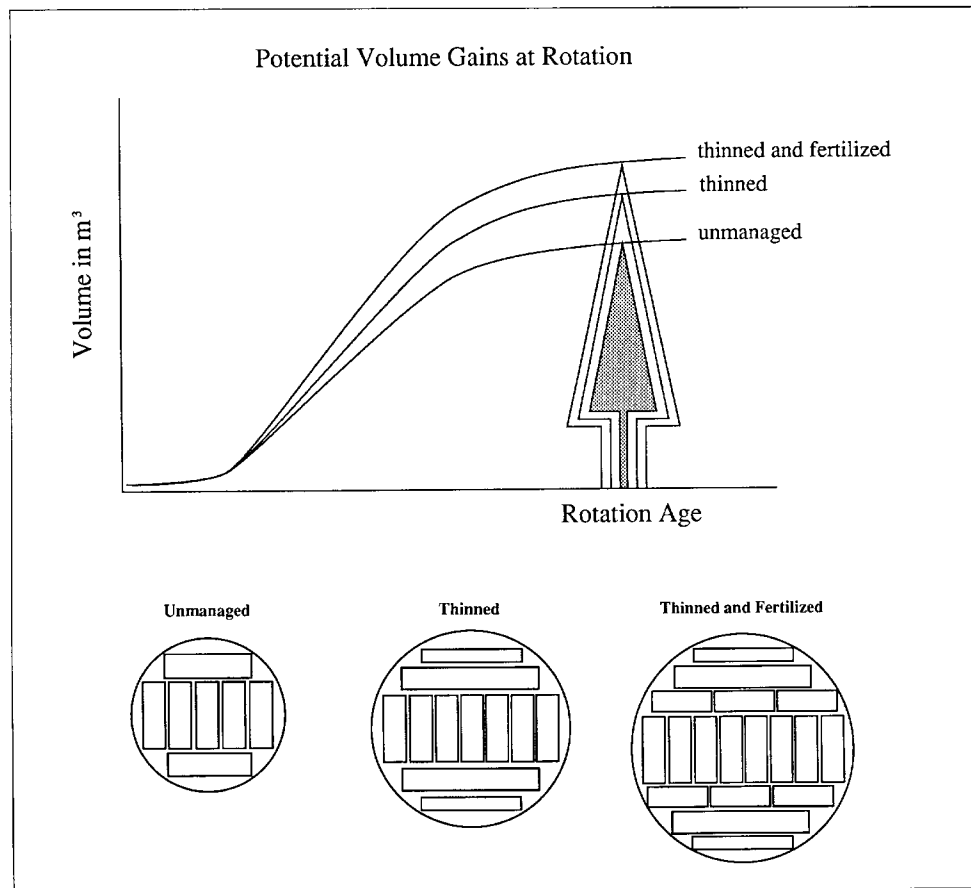

Through tightly controlled stand tending it is possible to reduce rotation lengths in managed stands by 25% or more of the rotation length of unmanaged stands, resulting in higher values in a shorter time period. In addition to producing crop trees in less time, the trees are often of more uniform piece size which can mean greater harvesting efficiencies and related cost-savings. Add to these economic returns the benefits of improved access, aesthetic, wildlife and protection values on your woodland, and stand tending becomes a good deal for all woodland operations, large or small.

Treatments should be planned carefully, in consideration of the costs and the potential responses in stand growth and value. Costs of treatment vary tremendously according to the site conditions, method and number of treatments. You are advised to consult foresters in your local area regarding specific treatment costs and applications.

For many of you, stand improvement will be the focus of your woodland activities, and you will be able to cut the costs of treatment considerably by doing the work yourself. In addition to improving the value of your forest crop, stand tending will provide you with the opportunity to create the stands on your woodland that work best for you.

Recommended References

Small Woodlands Program of BC

A comprehensive 'Small Woodlands Library' is available on the web [www.swp.bc.ca]

BC Ministry of Forests

Juvenile Spacing A Guide For Forestry Crews. Pamphlet
Silviculture Manual (chapters 9 and 12). Silviculture Branch
A Quick Guide to Pesticides. Use and Regulation in B.C. Forest Management'
Forest Pesticide Application Course. Handouts
Evaluating Forest Stand Nutrient Status. 1985. Land Management Report No.20
A Preliminary Guide to the Response of Major Species of Competing Vegetation to Silvicultural Treatments. 1986. Land Management Handbook No.9
Regional Stand Tending Guidelines"

BC Ministry of Water, Land and Air Protection

Handbook for Pesticide Applicators and Pesticide Dispenser. Pesticide Control Branch
Guide to Applicants for Pesticide Use Permits and Special Use Permits Canadian Forestry Service, Victoria
Use of Herbicides in Forest Management. CFS Information Report NOR-X-282
Fertilization and thinning effects on a Douglas-fir ecosystem at Shawnigan Lake: a 12-year growth response, 1985. Information Report BC-X-271
Soil Fertility, Fertilization and Growth of Canadian Forests, 1983. Information Report O-X-353

Forest Engineering and Research Institute of Canada (FERIC)

Use of the farm tractor in the forest: Evaluation of the Agri-Winch: A Farm Tractor-Mounted Logging Winch. TRAI
4WD Articulated Tractors and Skidders for Woodlots. TN-87
Hydraulic Grapple Loaders for Farm Tractors. TN-88 "Logging Winches for Farm Tractors." TN-90
Logging Trailers for Farm Tractors. TN-97
Evaluation of the G-30 – Vimek Processor Attachment for Farm Tractors. TN-99
Handbook For Logging With Farm Tractor-Mounted Winches. Handbook No.2 Small inexpensive equipment for woodlot owners who do not have a farm tractor: *Evaluation of Wood Caddy and Goliath Mini-Skidder*. TN-86
Can All-Terrain Vehicles be Used for Forest Work?
Pruning Douglas-fir on Coastal British Columbia. Interim Report IR-383-1

Other Sources

Juvenile Spacing Manual. Workers' Compensation Board
Forest Pesticide Handbook of British Columbia. 1985. COFI of BC
Proceedings of a Workshop on Pruning. 1987. U.B.C. Research Forest
The Practice of Silviculture. 1962. D.M. Smith. John Wiley & Sons
Silviculture – The Journal of the New Forest. MacLean Hunter Ltd. 777 Bay St., Toronto, Ont. MSW 1A7
Economics of Pruning Young-Growth Douglas-fir: A Preliminary Report. 1985. R.D. Fight. USDA Pacific Northwest Research Station

Equipment

Neville Crosby Industries/Canadian Forestry Industries, [www.cfe.ca]
Future Forestry Products, Inc. [www.futureforestry.com]

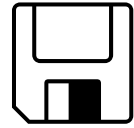

Forest Protection Basics

Forest Protection

In this chapter...

Introduction	226
Forest Fires	226
Forest Insects and Diseases	232
Forest Insect Pests	234
Forest Tree Diseases	238
How Do I Protect My Woodland?	242
What Else Can Damage My Forests?	246
Recommended References	247

.....

Introduction

Each year, approximately one million hectares of forest land in British Columbia are damaged or destroyed by the combined actions of fire, insects and disease. The protection of forest land is an ongoing task of prevention, early detection, and control of damaging agents. Private woodlands are just as susceptible to disease and insect attack as any forest although the consequences can be relatively more significant because of the small size of private woodlands and lower flexibility to withstand losses.

Forest protection encompasses management strategies for the following damaging agents:

- forest fires
- forest insects
- forest diseases
- other agents including animals, humans and environmental factors.

This chapter explains the various mechanisms that can cause damage or losses in your woodland and discusses the ways in which you can reduce risk, improve detection and find assistance for coping with problems if and when they occur. The purpose of the chapter is to help you to develop a protection strategy for your woodland.

Forest Fires

What Creates A Fire Hazard?

To have a fire three things are needed: fuel, oxygen and heat (for ignition). Needles, bark, twigs and wood provide fuel for ignition and for prolonged burning; forest air is rich with oxygen produced by plants growing on-site; and people and lightning act as sources of ignition. To fight fire, you must remove one or more of these elements. In the case of forest fires, protection efforts are focused on removing or modifying the fuels, regulating the movements and activities of people, and predicting the occurrence of lightning-caused fires.

In developing a fire protection program, it is important to know how fire behaves under different circumstances. The primary factors that influence fire behaviour in a forest are the fuels, weather and topography (lay of the land). A look at each of these will help you to assess the potential fire risk on your woodland.

Fuel exists in various forms in a forest. Dense, heavy fuels, such as standing timber, fallen trees and sound stumps are normally difficult to ignite and burn relatively slowly. Light flash fuels, such as logging slash, brush cuttings and other residues are easily ignited and burn rapidly. The presence of both types of fuel represent a potential fire hazard to the woodland. A preponderance of dead trees (e.g., beetle killed area) are a special concern because they are dead, dry and always ready for ignition.

The volume of fuel affects the amount of heat produced by a fire. The most dangerous fire situations exist where there are both light fuels for ignition, and medium and large materials for prolonged burning. Fuel spacing affects how quickly and to what extent a fire can spread. When fuels are close together, fire spreads faster. As a result a common fire suppression technique is to separate burning fuels from unburned fuels by creating a 'fireline' by hand or machine.

Weather exerts a strong influence on fire behaviour. Temperature affects the drying of fuels and the movements of air, while humidity (the moisture in the air) affects the moisture in the fuel. Dry air during the day draws moisture away from fuels making them more combustible, while moist, night air (dew) can actually dampen the fuels and reduce their combustibility or slow down a burn. Wind patterns change during the day, generally blowing upslope during the day as sun-warmed air rises and downslope during the night as cooler air sinks. Wind also speeds the spread of fire by bringing fresh supplies of oxygen. Pre-heating fuels in front of the fire, and igniting spot fires by carrying embers to new fuels.

The terrain, or topography, affects the rate and direction in which fire can spread. Fire tends to spread faster uphill than downhill, and the steeper the slope, the faster the spread. Aspect, the orientation of the land to the North, East, South and West, affects the amount of sunlight that

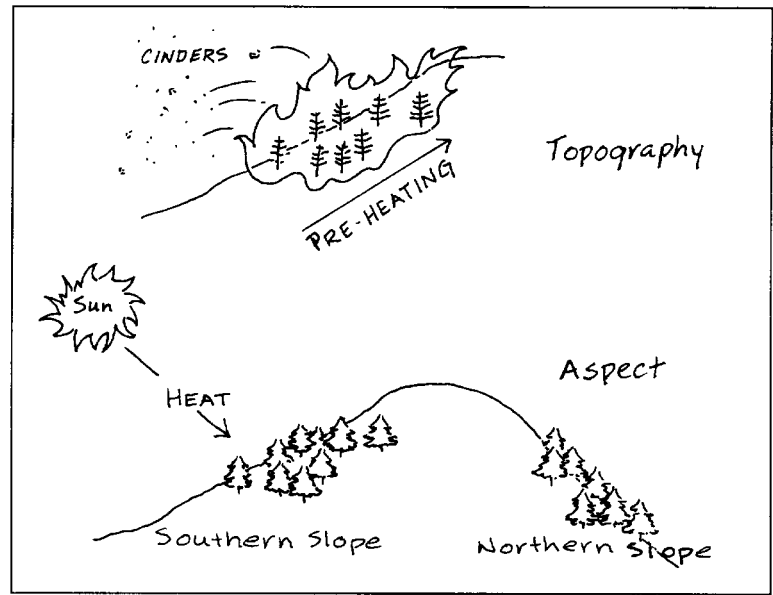

an area receives. South-facing slopes expose fuels to direct sunlight, which causes rapid drying. Such slopes are potential 'hot spots' and should be watched carefully in the summer months. North-facing slopes, where fuels are more shaded, and often more dense, pose less of a fire risk. Fire behaviour is also affected by terrain because of its influence on the movement of wind. Landforms such as ridges and rock faces may cause wind turbulence and eddies on their leeward side. When wind is channeled it increases in strength, and in chutes or steep drainages a chimney effect can make fire behaviour extremely dangerous.

What Is My Role In Fire Protection?

The only factors in the fire formula that you can influence are your actions (as a potential source of ignition) and, to a lesser extent, the availability of fuel (by managing your slash and maintaining healthy stands). Your role in fire protection is to:

- prepare for it
- try to prevent it
- watch for high hazard situations
- be ready to act quickly if and when it strikes.

It is very important that fire protection be part of your overall Forest Management Plan which should include a protection strategy with the following four core elements:

1. prevention
2. preparedness

3. detection
4. suppression.

Fire Prevention

Never was the old saying ‘an ounce of prevention is worth a pound of cure’ more true than in the case of forest fires, where the values at risk to timber, range, recreation, wildlife habitat and water are so high. Prevention usually focuses on two areas: *modifying the activities* that take place in the forest, according to the degree of fire danger and risk, and *reducing or modifying the forest fuels* to reduce fire hazard.

Modifying activities involves planning the timing of forest operations to ensure that you avoid operating during high fire hazard conditions and recognising when you should stop work when the hazard becomes too high. Schedule high hazard activities such as burning or certain harvesting activities to take place in the late fall or winter when there has been ample rainfall or the surrounding ground and forest is covered in a protective blanket of snow. Also make sure your machinery and tools have adequate and proper fire prevention and suppression equipment (e.g., spark arrestors, muffler guards, automatic fire extinguishers installed into the engine compartments of heavy machinery) and that this equipment is working.

Proper placement and construction of recreational facilities especially fire pits is important to fire prevention. Fire pits should be built into mineral soil and all organic soil and roots should be removed from the perimeter area of the pit. Forest fires often go underground into dry organic matter and can burn away slowly for weeks before the right conditions emerge that allow it to flash up and spread into the above ground vegetation and surrounding forest cover.

Reducing forest fuels are the other targets of fire prevention activities. Firebreaks (areas of less flammable fuels) and fuel-breaks (areas where fuels have been burned off) can be used to decrease the chance of fire start and spread. Existing fuels can also be modified by practices such as controlled understorey burning, to reduce the potential rate of fire spread and harvesting overaged or diseased stands where there are higher amounts of dead, dry material. Many forest fires start from a carelessly thrown cigarette, a hot car tailpipe, sparks from logging equipment, or heat generated by a chainsaw blade or muffler. Grass and small brush can be removed from forest areas of higher hazard through machine mowing or brushing of roadsides, or selective grazing with cattle or sheep.

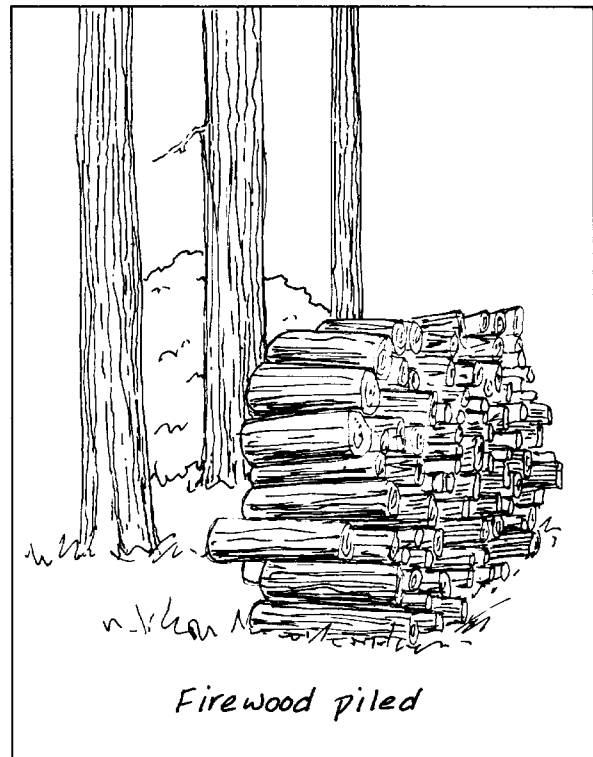

Fuel management strategies also include such measures as:

- increased utilization of wood on-site (e.g., removing slash for firewood or small log products)
- clearing fire guards around areas of high risk, such as slash
- cleaning up slash on road rights-of-way (e.g., 5 m back from road sides)
- making sure cutting, spacing, pruning or harvest slash lies flat on the ground to speed up decomposition
- prescribed burning or mechanical site preparation to reduce fuel hazards
- limiting cutblock size in cases where slash disposal might be difficult
- leaving areas of standing timber as firebreaks
- removing lower branches through pruning (to 2 m) to reduce the risk of low intensity ground fires moving in to the crown of the tree.

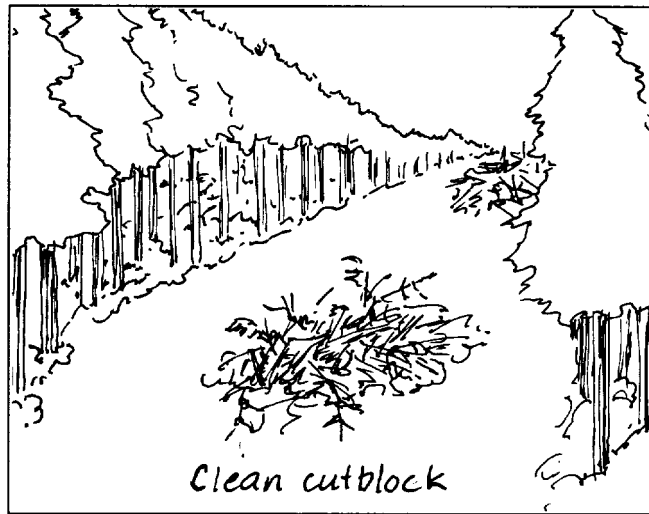

It is recommended that you prepare a written fuel management plan as part of your Forest Management Plan. Its purpose is to identify potential fire problems on the woodland and the fuel management strategies to combat them. The fuel management plan is based on the fire history, weather, and type of fuels in the area, including social considerations such as level of use. Much of this information is available from the local district offices of the Ministry of Forests.

Be aware that the Forest Fire Prevention and Suppression Regulation influence activities taking place on Crown and private forest lands during the fire season, April 1–October 31. For instance, permits are required for all burning except for campfires and some categories of backyard burns during fire season. In times of high or extreme fire danger authorities will often issue an outright ban on all burning including campfires. In addition, bans may be issued due to poor ventilation conditions and concerns about health issues due to smoke, especially in populated areas. These bans can also be placed during other times of the year including winter if conditions are not right. This information is usually broadcast through the media but is also available from your local forest district office, the Ministry of Land, Water and Air Protection, on the internet, or from your local fire department. Call before you burn!

Fire Preparedness

Early detection and quick suppression are the key to fire preparedness since a quick response greatly enhances the chances of early control, being prepared for fire is an important part of the fire protection plan. This includes:

- knowing what the danger is
- having the appropriate suppression equipment on hand for the size and type of your woodland operation

- having a source and supply of water on hand
- having a plan in place for initial attack if and when a fire occurs.

The objective of forest firefighting is to contain all wildfires by 10 am (when it starts to get hot and dry) of the day following discovery, as fires are generally small and localised near the point of ignition at this stage, (if they have been discovered early enough), and because they will not have had much of an opportunity to burn and spread during the cooler, moister overnight conditions. You could adopt a similar response objective. Quick response is the key to keeping fires small, safe, manageable and least damaging.

Part of being prepared is **knowing when the risk of fire is highest**. The Ministry of Forests maintains a fire danger rating system to measure the susceptibility of forest lands to fire. The system uses weather variables of temperature, relative humidity, wind speed and rainfall to model the condition of forest fuels and develop an index of fire danger. The fire danger rating is used in making decisions regarding the regulation of forest land activities including the need for early shifts (so forestry and logging crews finish work and leave the forest before temperatures and fire danger peak) and temporary shutdowns of operations, or forest closures. The fire danger rating is usually posted on a fire index board in front of all forest district offices and along major forest access roads and highways around the province. Learn how this system works and what it means.

Another aspect of preparedness includes **having fire fighting equipment on hand to stop fires as they develop**. Equipment needs to be properly functioning, portable and you should have an adequate water source on hand or nearby. Fire suppression equipment must be portable and includes fire extinguishers, water cans, portable water tanks and pumps, hose, and adequate hand tools (shovels, mattocks) on site during all active operations. This equipment is readily available at all forestry equipment supply outlets, but can also be built easily and cheaply with parts salvaged from agricultural spraying equipment.

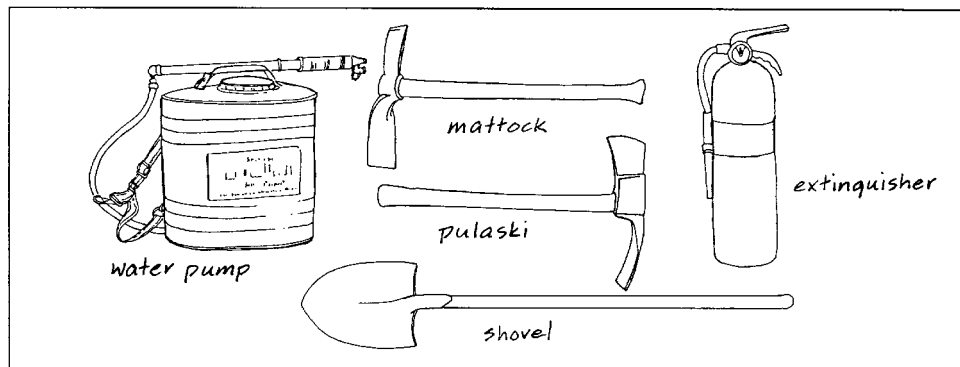

BC has detailed Forest Fire Prevention and Supression Regulations that apply to Crown and private lands.

Knowledge of one's land and potential hot spots, the basic steps of fire fighting, and who to call in the event of fire, are additional safety measures. The Ministry of Forests or your local woodlot association periodically sponsor one day mini-courses in fire suppression training and has other excellent written and video materials on fire protection appropriate for all categories of woodland operators. Check with your district office.

It is recommended that landowners develop a fire protection pre-organization plan as part of the Forest Management Plan. The pre-organization plan outlines the fire protection

strategy for the woodland and will help you assess your resources and work through a plan of action in the event of a fire.

Being Prepared for Fire:

1. Develop a fire prevention strategy for the site (especially fuel management)
2. Keep a phone list at home, on-site, in your vehicle with:
 - fire report number: 1-800-663- 5555
 - MOF district office
 - local fire department/volunteer squad
 - three neighbours who have agreed to be on call as fire fighting recruits
 - hospital
3. Between April 1 and October 31:
have the following equipment on site
(for 1–3 person crew):
 - 1 shovel
 - 1 pulaskis
 - 1 handtank pump

plus for *each small engine* (chainsaw, brushsaw):

 - 1 fire extinguisher (0.5lb)
 - 1 spark arrestor
4. Know the fire danger rating in your area
5. Develop a water source on site if necessary (roadside water holes, holding tanks)
6. Map all access routes and possible sources of water on-site; leave a copy with MOF district office, friends, at home and in your vehicle
7. Control public access. Check the area after logging or other operations and lightning.

Fire Detection

Your fire detection activities should include maintaining an overall fire patrol routine for your woodland during periods of high fire hazard and after lightning and in areas where forestry work is being carried out. Well maintained access roads in your woodland will facilitate monitoring and allow you to get your suppression equipment to a fire quickly and safely.

What Are My Fire Responsibilities?

Where fire is concerned, little distinction is made between Crown lands and private lands. Everyone owning or occupying forest land is equally responsible for fire prevention and suppression. You are required to dispose of slash on your lands, including the falling of snags and slash burning, and take other measures to prevent the outbreak of fire. Where fire occurs, you are required (under the *Forest Act*) to report it and take initial, aggressive action in suppressing it. When a fire moves beyond the operator's suppression capabilities, the Ministry of Forests may take over, and if required to do so, the operator and his equipment must be at the disposal of the ministry. If you are responsible for a fire outbreak due to operational negligence, or fail to take initial suppression action, you may

be liable for suppression expenses incurred by the Ministry of Forests, or even prosecution.

The policy of the Ministry of Forests is to make sure that forest fire control action is taken on any land, regardless of ownership or tenure. The Federal Department of Indian and Northern Affairs has made arrangements with the Ministry of Forests to suppress fires on Indian Reserve lands.

Fire and the Urban Interface

As communities grow, more people are moving to small properties in forested areas in the urban rural interface. Many private woodlands are also located in these areas. This has dramatically increased the risk and occurrence of property damage and loss of life during forest fire events in recent years. As a woodland owner, if you live on your woodland property, you should be aware of the risks and include your home and yard in your fire preparedness and prevention plan. The basic consideration in being prepared for a forest fire in your neighborhood is to establish a “defendable space,” and around your home and outbuildings and furthermore within your immediate neighborhood. Things you can do to create this defendable space include:

- manage any forest stands surrounding your home to reduce fuel loads by keeping the understorey clean, by removing dead trees and keeping the stand healthy and productive
- establish firebreaks beyond your yard area and immediately surrounding amenity forest
- keep your yard area clear of accumulations of combustible materials, including long grass and large areas of shrubs
- select fire resistant roofing materials and exterior finishes
- set up an emergency sprinkler system to keep you buildings wet in the event of a nearby fire – have an adequate pump on hand and sufficient fuel or a back up generator to keep the sprinkler running during an emergency situation
- keep valuable papers and other items in a safe location
- have an emergency evacuation plan.

Forest Insects and Diseases

Forest insect pests and diseases which inhabit our forests cause millions of dollars worth of timber losses each year. Forest insect pests and disease agents attack a wide range of tree species and ages, retarding growth, affecting tree form, reducing wood quality and in some cases, killing trees outright. They also leave their mark by delaying regeneration, changing species composition, affecting water quality and recreation values, and damaging wildlife habitat. Worse still, in the wake of this destruction, they often create a fire hazard.

The provincial Forest Service takes the lead role in protecting BC’s forests against insect and disease by conducting annual surveys and carrying out operational research. The provincial government is also responsible for determining provincial pest policy, and administering control measures on Crown lands. Some forest companies employ pest management foresters to oversee protection programs on company owned and Crown licenced forest lands. The federal government forest service also conducts research and monitoring programs for pests that present a national threat.

Successful pest management begins with prevention and early detection. Through special management practices, attempts are made to prevent or disrupt conditions favourable to particular pests. These may include such things as planting species that are resistant to local pests, managing stands for a mixture of species and age classes, harvesting stands before they become overmature, maintaining clean logging practices, and practicing sanitation cutting to remove infected trees. In many cases the best prevention and control can be done along with other activities in your woodland, such as regeneration, thinning or harvesting.

Once a problem has been identified and its potential damage appraised, a suppression plan is designed. Control measures may attempt to directly or indirectly manipulate the pest's life cycle or the forest environment in which it lives. For instance:

- trap trees and logs are used in the control of spruce beetle and Douglas-fir beetle
- prevention of population buildup of Douglas-fir beetle is controlled by practicing good utilization standards
- population buildup of Douglas-fir beetle, spruce beetle, and western balsam bark beetle may be prevented by quick removal of felled timber (which attracts beetles) from the logging site
- root rot centres can be detected, harvested and treated by stumping to prevent spread
- biological agents, such as viruses, bacteria, fungi, mites, birds and mammals are being tested for their effectiveness as parasites or predators on particular pests, including defoliating insects
- pesticides are used under stringent regulations prescribe by the *Pesticide Control Act of British Columbia*.

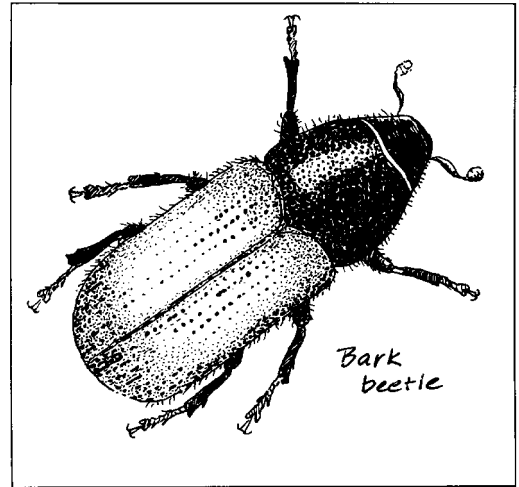

This chapter discusses the general guidelines for prevention and detection of pest problems on your woodland. Since specific control measures vary throughout the province you are advised to contact the district office of the Ministry of Forests to refer to the regional guidelines that set out the procedures for pest detection and control in your area. Also refer to the Forest Practices Code guidebooks which provide detailed management guidelines for several important insect and diseases present in BC.

How Do I Recognize a Pest Problem?

Pest infestations are sometimes hard to identify, especially in the early stages of attack or infection. Insect and disease pests often cause similar symptoms in the affected trees. To begin the process of detection and appraisal you can do three things:

1. Become familiar with the general warning signs of pest problems (a chart of basic symptoms follows).
2. Find out which major forest pests are currently active in your region. Since the problem species can change radically from year to year, consult with your district office of the Ministry of Forests.

- Based on the tree species in your inventory, identify which pests are most likely to be in your woodland, then find out the specific symptoms of each (insect and disease charts are included in the following sections to help you).

Armed with these clues, do a check on your woodlands. If you find evidence of damage that you suspect may be caused by a forest pest, remove a portion of the affected trunk, branch, foliage, bark or cone. The district office of your Ministry of Forests may be able to help you identify the offender and offer suggestions on means of control, or you can mail the sample, along with any related description or supporting information, to the Canadian Forest Service in Victoria (see appendix for address) for assistance in identification. You are advised to take every available opportunity to check your woodland for signs and symptoms of pest attack—during casual walks, silvicultural assessments, and road layouts, as well as during specific pest management cruises. For field reference, the *Field Guide to Forest Damage in British Columbia* is recommended. (See Recommended References for full details).

A general check list of symptoms of pest damage and the potential causes follows. More information on the damage done by particular pests is provided in following sections.

<i>General Symptom</i>	Symptoms of Pest Damage	
	<i>Potential Pest</i>	<i>Other Signs</i>
Thinning of foliage and discoloration	<ul style="list-style-type: none"> defoliating insect root rot foliage disease (i.e., rusts and needle casts) 	<ul style="list-style-type: none"> chewed needles, buds yellowish needles both normal and discoloured needles; spots
Dead crowns	<ul style="list-style-type: none"> bark beetle root rot 	<ul style="list-style-type: none"> pitch tubes, galleries under bark 'sawdust' on bark resin or white 'mycelium' (thread-like strands) at root collar
Witches broom	<ul style="list-style-type: none"> mistletoe rusts/needle cast 	<ul style="list-style-type: none"> attacks interior Douglas-fir larch, coastal hemlock, lodgepole pine attacks balsam, spruce, ponderosa pine
Broken tops, conks, cankers	<ul style="list-style-type: none"> decay fungi 	<ul style="list-style-type: none"> scars
Windthrown trees	<ul style="list-style-type: none"> root rots 	<ul style="list-style-type: none"> mushrooms at base of tree

Forest Insect Pests

Many thousands of insect species are at work in the forests of BC attacking trees from above and below, eating foliage, boring into bark, attacking cones and seeds and damaging wood. Most of the damage is done by a few major players, including the bark beetles, the defoliators, and the root and shoot feeding weevils. The following check list can help you determine which types of insects to watch out for in your woodland. Keep in mind that both insects and diseases appear in different phases of their life cycles at different times of the year, and that it may be easier to see the particular pest at a certain point in its cycle. For instance, budworms may be seen most readily as larvae and moths, and rusts will be most visible when they are orange and fruiting in early spring.

Types of Pests and the Trees They Attack						
<i>Tree of Attack</i>	<i>Foliage Feeders</i>	<i>Bark Beetles</i>	<i>Branch/ Stem Feeders</i>	<i>Cone & Seed</i>	<i>Terminal Shoot</i>	<i>Wood Damage</i>
<i>Conifers</i>						
Douglas-fir	◆	◆		◆		◆
western redcedar	◆					◆
western hemlock	◆					◆
western larch	◆	◆				
spruce	◆	◆		◆	◆	◆
balsam (true firs)	◆	◆	◆			
lodgepole pine	◆	◆	◆		◆	
ponderosa pine		◆				
western white pine		◆				
Scotch pine					◆	
<i>Deciduous</i>						
aspen	◆					
cottonwood	◆					
birch	◆					
willow			◆			◆
dogwood	◆					
alder	◆					
maple	◆					

Types of Insect Damage

Bark Beetles

Bark beetles are small, cylindrical insects that attack and kill mature trees by boring through the bark and mining the phloem—the layer between the bark and wood of a tree. They chew out ‘galleries’ in which to lay their eggs. Within a few weeks the eggs hatch, but the beetle larvae remain in the tree until the following year, extending the network of galleries and eventually eating their way out. They emerge as beetles who then fly on to attack new trees. The combined action of the larval feeding and a fungus introduced by the beetle disrupts the translocation of water and nutrients within the tree, and typically results in tree death. The fungus carried by the adults penetrates the sapwood of the tree, creating a blue stain that degrades the appearance and value of the wood.

Healthy trees can often withstand light attacks by exuding pine sap or ‘pitch’ that expels invading beetles. The presence of whitish coloured pitch tubes may indicate that the tree has repelled a beetle attack. Reddish brown pitch tubes on pine are an indication of attack.

The most important species of bark beetles are the mountain pine beetle, the spruce beetle and the Douglas-fir beetle. These insects inhabit forests throughout British Columbia. Like forest fires, bark beetles play an important role in the natural life cycle of a forest. By attacking older or weakened trees, bark beetles help hasten the development of younger forests.

Beetle Characteristics

Mountain pine beetle, spruce beetle and Douglas-fir beetle are closely related and can be difficult to tell apart without a detailed knowledge of insect anatomy. However, the beetles can be distinguished by the trees they inhabit and the duration of their lifecycles.

Mountain Pine Beetle

Attacks lodgepole pine, ponderosa pine and white pine trees from mid-July to mid-August. Mountain pine beetles have a one-year life cycle.

Spruce Beetle

Attacks Englemann spruce, white spruce and Sitka spruce trees from late April to early May. These insects have a two-year life cycle.

Douglas-fir Beetle

Attacks Douglas-fir trees from late April through May and has a one-year life cycle.

Hot dry summers, mild winters and an abundant food source allow bark beetle populations to quickly reach epidemic levels in mature forests. When this occurs, natural predators like woodpeckers cannot reproduce quickly enough to maintain the insect population at manageable levels. Large tracts of younger, apparently healthy trees can also be killed under these conditions.

Over the past 80 years, it has been estimated that more than half a billion trees have been killed by bark beetle attacks. An area is considered infested when more than 10 trees per hectare are being attacked by bark beetles. Serious infestations increase fire hazards and damage environmental and wildlife values within affected zones. Outbreaks generally last eight to 10 years.

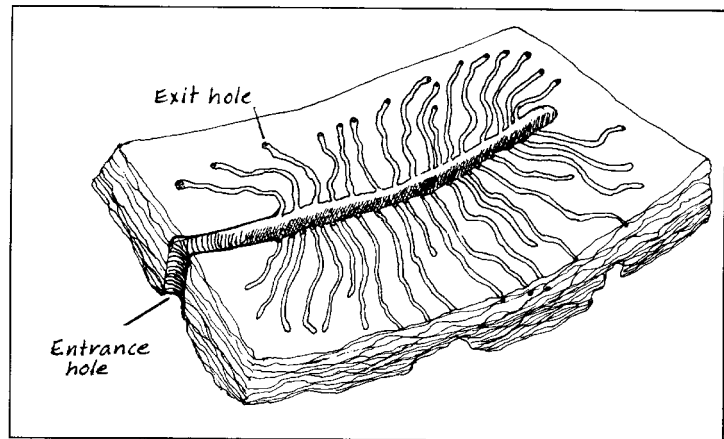

Another beetle with significant impact in BC is the Ambrosia beetles which attack logs left on dry land and the upper portions of logs in booms. As they bore into the wood they introduce a black-staining fungus reduces its value. All commercial tree species are susceptible to attack. Interior spruce and pine logs exposed during the summer months are subject to similar damage from sawyer beetles.

Beetle Quick Facts

Total area in BC infested in 1999: 125 289 hectares.

Under epidemic or outbreak conditions, enough beetles can emerge from an infested tree to kill two or more trees of the same size the following year.

Tree foliage turns yellowish to reddish within 10 months after a successful beetle attack.

The direction and spread rate of a beetle infestation is impossible to predict. However, attacked trees are usually near previously killed trees, and often follow the pattern of prevailing winds.

Some bark beetles in firewood can infest nearby healthy trees.

Defoliators

Insects that feed on the leaves or needles of trees are known as defoliators. They include budworms, loopers and other caterpillars. These larvae feed on the developing buds and new foliage of trees, causing height loss, deformity and reduced growth. After attack, the foliage is reduced, remaining damaged needles turn brown and wood growth slows down. Defoliation can weaken trees, making them susceptible to attack by other pests, and successive years of defoliation can kill trees outright.

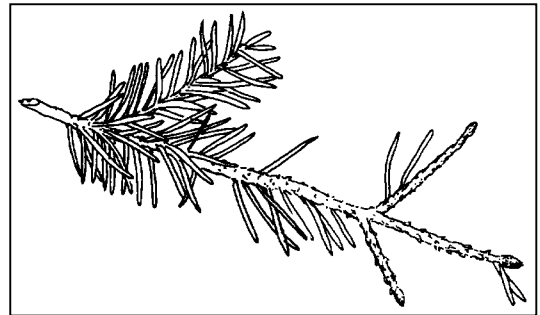

Cone Insects

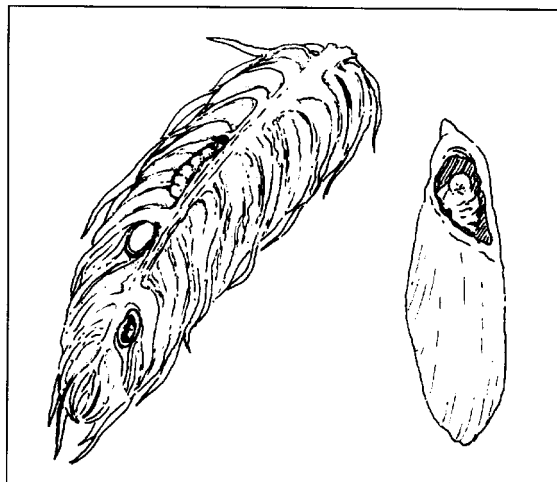

Insect pests also attack tree cones, destroying the seeds of the next generation of forests. These insects are particularly feared in the seed orchards of the province where large amounts of genetically superior stock are being developed for extensive reforestation programs. They also affect wild cone collections which can, in turn, reduce the level of natural regeneration success.

The insects responsible for much of the damage to BC forests, the tree species they attack, and some external indicators of their presence are summarized in the table that follows.

Insect Damage		
Insect	Tree of Attack	Visual Clues
mountain pine beetle	(mature) lodgepole pine western white pine ponderosa pine	reddish white pitch nodules on trunk; egg galleries under bark; one-year old infested trees have red foliage
spruce beetle	(mature) Engelmann spruce white spruce Sitka spruce	bore holes in bark and evidence of sawdust; egg galleries under bark
Douglas-fir bark beetle	(mature) Douglas-fir	sawdust on bark; egg galleries under bark
ambrosia beetle	all conifers (felled and bucked material)	wood-coloured 'frass' or sawdust on logs
western spruce budworm	interior Douglas-fir	larvae feeding on developing buds and new needles
fir-spruce budworm	alpine fir interior spruces	larvae feeding on developing buds and new needles
western blackheaded budworm	western hemlock	larvae feeding on developing buds new needles
Douglas-fir tussock moth	(dry belt) Douglas-fir	larvae feeding on new and older foliage

Mature trees are not the only targets of attack. You should also be aware of the pests that can damage your plantations. Black army cutworm is a potential problem on burned sites in the interior dry belt. It is a single-season pest whose larvae prefer deciduous foliage, so it is often 'treated' by postponing planting until the second or third season after burning, when deciduous species such as fireweed may be on-site (to attract the attention of *any* hungry cutworms) yet not large enough to cause severe competition to new seedlings. Budworms can be a potential problem, so check for signs of these insects in adjacent stands. Weevils may be responsible for any signs of terminal (top shoot) or root collar damage.

Forest Tree Diseases

Disease organisms are responsible for more damage to BC forests than insects and fire combined. Diseases are usually restricted to specific parts of the tree, and like insect pests are named by the part of the tree they attack, such as root rots, heart rots, leaf spots and stem cankers.

They disrupt the normal growth functions of the tree causing specific injury, poor quality wood, reduced tree growth and sometimes death. Specific diseases can be encountered at almost all stages of a tree's development.

Tree diseases, like human ones, come in a number of forms. These include rots, rusts, cankers and decay. Most decay fungi

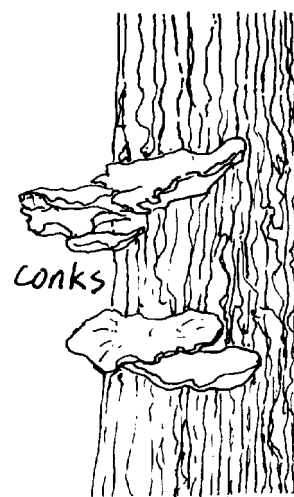

are microscopic organisms that reproduce by spores. At certain stages in their life cycle some fungi produce large spore-producing 'fruiting bodies' which we recognize as mushrooms or conks. Diseased plants exhibit symptoms in reaction to the presence of the fungus. Trees infected with root rot develop yellowish needles. Those affected by rusts display red or brown spotting on their needles, and those with heart rot have internally decayed wood.

Disease problems are often harder to detect than insect problems, simply because the evidence of damage is not always easy to see. Even when it is, you still need to know what to look for. The following check list indicates the major disease categories and the tree species vulnerable to them.

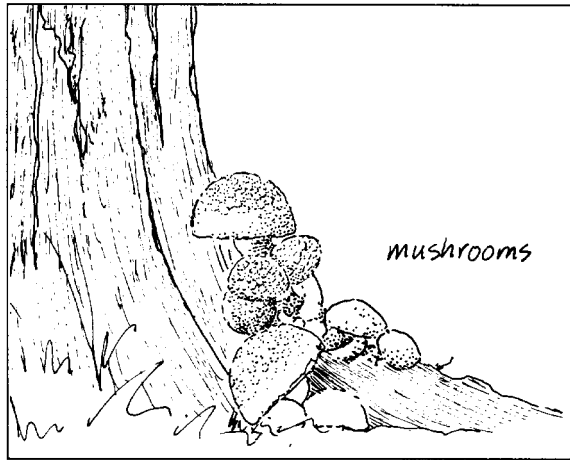

For further information on disease identification, consult *Common Tree Diseases of BC* or *Forest Disease Management Notes*, available for reference in most district offices of the Ministry of Forests. Both these publications have excellent colour photography to help you identify the suspected tree diseases. Another good reference is the *Forest Pest Leaflet* series published by the Canadian Forestry Service.

Types of Disease Damage

Wood decay accounts for about half of all the forest losses to disease. It is a slow killer, working from the inner heartwood out toward the sapwood, that damages the tree's stability and leaves it vulnerable to blowdown. Decay is caused by various fungi that enter trees through scars and wounds. Though it is currently more of a problem in old growth stands than in second growth ones, it is nevertheless a potential threat to second growth forests. Some interior second growth spruce forests have particularly high levels of decay.

Types of Diseases and the Trees They Attack							
<i>Tree of Attack</i>	<i>Root Rot</i>	<i>Heart Rot</i>	<i>Sap Rot</i>	<i>Dwarf Mistletoe</i>	<i>Cankers</i>	<i>Foliage Diseases</i>	<i>Rusts</i>
<i>Conifers</i>							
Douglas-fir	◆	◆	◆	◆	◆	◆	◆
western redcedar	◆	◆	◆			◆	
western hemlock	◆	◆	◆	◆	◆		
western larch	◆	◆	◆	◆		◆	
spruce	◆	◆	◆		◆	◆	◆
balsam (true firs)	◆	◆	◆		◆	◆	◆
lodgepole pine	◆	◆	◆		◆	◆	◆
ponderosa pine	◆	◆	◆		◆	◆	◆
western white pine	◆	◆	◆		◆	◆	◆
Scotch pine						◆	◆
<i>Deciduous</i>							
aspen	◆	◆	◆			◆	◆
cottonwood		◆	◆		◆	◆	◆
birch		◆	◆			◆	
maple			◆		◆		
willow					◆	◆	◆
dogwood					◆	◆	
arbutus					◆	◆	

Root Rot

Root rots are diseases caused by fungi that spread from infected root systems to those of healthy trees. The potential for damage is great because of the difficulty of detection and the ease of spread. The worst of the rots can live in stumps for up to a century and survive even forest fires if the infected roots are insulated from the heat by the soil. In some cases the spread of root rot may be done without actual contact between the infected and the healthy root system—when fungi are spread by means of small, thread-like structures (mycelium) that stretch out through the soil from the infected roots.

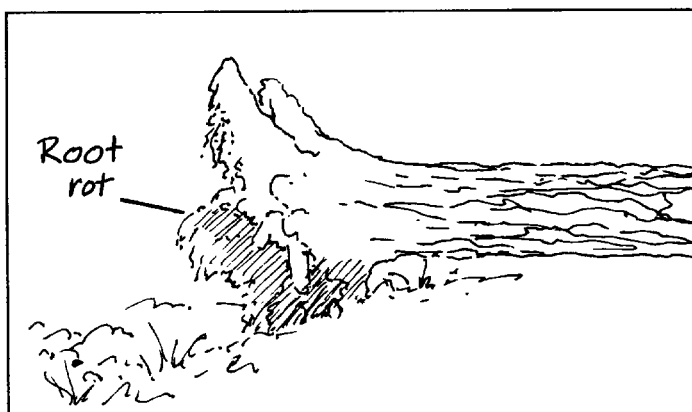

Root diseases retard tree growth and can lead to susceptibility to blowdown. Young, second growth forests are particularly vulnerable to root disease and should be monitored carefully for signs of pockets of dead or dying trees. Most coastal Douglas-fir forests have laminated root rot (*Phellinus weirii*) occurring within them. Root disease can also kill seedlings and pole-sized trees.

Stem Disease

Stem diseases such as rusts and cankers weaken the tree, damage wood and reduce growth. Rusts tend to attack young trees and are often identified by the presence of cankers on the branches and trunks of infected trees and dead or dying tops. The rust fungus enters through the tree's needles, and travels through the bark (often creating branch cankers) to the main stem where it forms cankers that girdle the tree. Young plantations are especially vulnerable, and rusts pose a potential threat to the extensive lodgepole pine forests in the interior of the province. Rusts generally require two hosts to complete their life cycle, such as white pine blister rust whose alternate hosts are currants and gooseberries (ribes species).

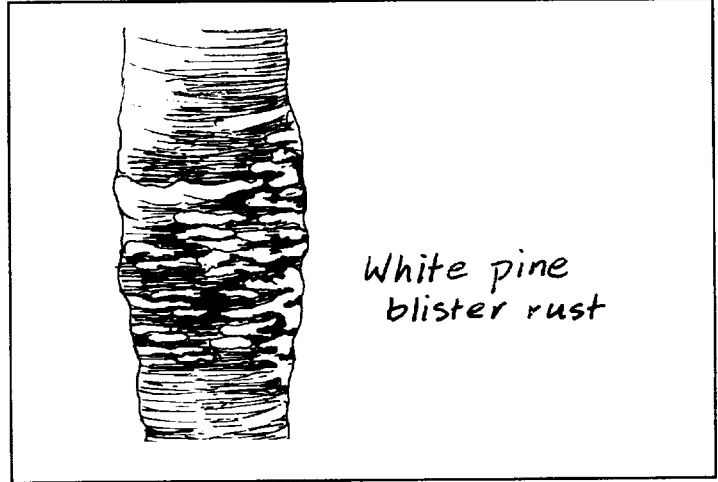

Dwarf Mistletoe

Dwarf mistletoes are parasitic flowering plants that attack four of the province's most valued tree species: interior Douglas-fir, lodgepole pine, coastal western hemlock and western larch. Not to be confused with the leafy mistletoe we use for celebrations at

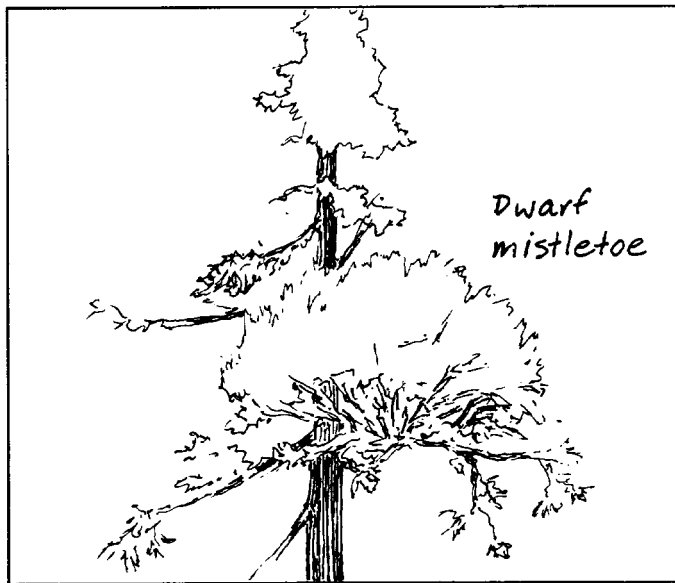

Christmas time, dwarf mistletoe causes severe damage to our provincial forests. Mistletoe spreads through a stand by ejecting its seeds at high speeds, and covering distances of up to six metres. The mistletoe attaches itself as a sticky seed to the tree, then sends roots through the bark and into the tree to tap water and nutrients.

The infection is recognizable by large swellings on tree stems or branches and by 'witches broom,' a dense tangle of branches. While it rarely kills the host tree (other than larch), it drastically reduces growth and leaves the tree vulnerable to attack by other disease or insects. In old growth stands it can substantially decrease the value of the tree, while in second growth, the effect is mainly a reduced rate of growth.

Foliage on young trees, and cones on older trees, are also disease targets. While foliar disease results mainly in cosmetic damage and is a problem for ornamental species and Christmas trees cone diseases can drastically reduce regeneration success. Spruce cone rust, which leads to malformation and premature opening of cones has had a serious effect on cone collection programs in the northern interior. The impact of cone and seed diseases will increase with the move to second growth forests and extensive regeneration programs.

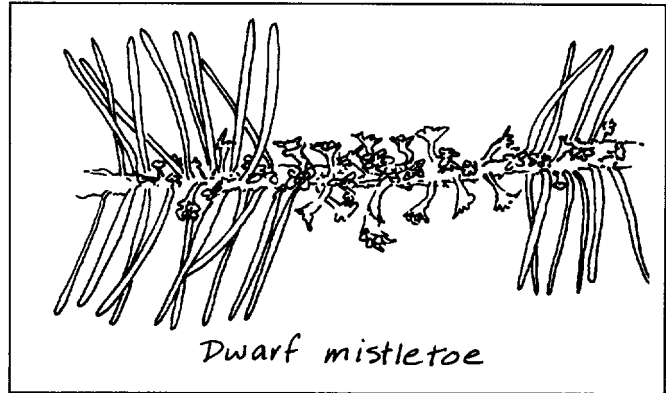

How Do I Protect My Woodland?

As part of your inventory and Forest Management Plan you are encouraged to develop an insect and disease map of your woodland. This will help you to become familiar with the pests that are present, and to make it possible for you to monitor their activities over the years. Contact your district office of the Ministry of Forests for information on how to conduct a pest survey to detect the presence and extent of insect pest and disease threats on your woodland. The Forest Practices Code *Forest Health Surveys Guidebook*, the *Root Disease Management Guidebook*, the *Bark Beetle Management Guidebook*, the *Defoliator Management Guidebook*, and the *Dwarf Mistletoe Guidebook* provide excellent references for detection, surveys and management.

Similar to bacteria in our bodies, pests can be present in a forest without causing undue harm. Pests become problems when some event in the woodland triggers a population outbreak or causes particular trees to become more vulnerable to attack. In most cases, pests will follow a cycle, and may only present real problems two or three times in a rotation period. In general, pest outbreaks are easier to prevent than control so forest management techniques that keep your trees healthy and strong are an important part of your protection plan.

Management techniques, such as the creation of a mosaic of age classes (either as even-aged or uneven-aged stands) can help break up your woodland and prevent the development of simultaneous outbreaks over large areas. Silvicultural treatments, such as pruning and thinning can be effective in dealing with specific pest-to-host relationships such as white pine blister rust. Juvenile spacing and thinning are important protection activities for second-growth stands. Infected stems should be removed as early after detection as possible. Genetic research into disease-resistant strains of trees offer a ray of hope, but one that is still a long way off. An alternative involves planting or encouraging the natural regeneration of species that are not affected by pests that are well-established in the region.

Preventing Insects and Disease:

- remove low vigour or cankered trees that could be susceptible to insects
- maintain vigour by thinning, and avoid damage to remaining stems
- clean areas of fresh windfall, logging slash
- carefully match regenerated species to the growing site
- inspect stands for signs of disease or insect damage
- watch stored wood for signs of insect infestation (such as ambrosia beetle).

Pest control is often difficult for the small-scale woodland owner since lands adjacent to his woodland are likely to be infected as well. Where you identify a pest problem, seek the support of a coordinated control effort with the Ministry of Forests and other woodland operators in your area, perhaps through your local woodland association. Chemical control is an issue you should discuss with the specialists at your district office of the Ministry of Forests. Strict regulations apply to the use of pesticides in British Columbia's forests.

Controlling Insect Pests

Mountain Pine Beetle Management

Because of the scale of beetle management issues in BC, the provincial government works with tenure holders and private land owners to reduce beetle populations to manageable levels while maintaining the ecological integrity of existing ecosystems. Mountain pine beetle populations can be detected by aerial and ground surveys. This information helps forest health experts and woodland owners choose appropriate techniques for preventing and managing infestations.

In some cases, the following preventive strategies can be used to reduce the buildup of beetle populations:

- reducing tree density to less than 500 trees per hectare
- establishing a mix of species, age classes and sizes within the area
- harvesting trees as soon as they become mature.

Management strategies for Mountain Pine Beetle

Pheromone baiting—luring beetles into trees baited with a synthetic hormone that mimics the scent of a female beetle. This technique helps contain the beetles in a single area, where they can easily be destroyed by falling and burning.

Sanitation harvesting—removing single infested trees to control the spread of beetle populations to other areas.

Fall and burn—falling and burning beetle-infested trees to prevent the spread of beetle populations to other areas. This technique is usually done in the winter to reduce the risk of starting forest fires.

Pesticide—injecting infested trees with the pesticide ‘MSMA,’ which kills beetle larvae.

Snip and skid—removing groups of infested trees scattered over a large area.

Mosaic burns—controlled burning of a concentration of infested trees that are contributing to high beetle populations in the area. This also reduces the fire hazard in the area.

Clearcutting—is used to reduce large beetle populations in severely infested areas and minimize further attack. However, this technique can have negative impacts on other forest values, and is therefore not an appropriate treatment option in parks and protected areas.

Attacked trees are identified by mapping infested trees in susceptible stands. Management strategies are based on this information and must be designed and applied in a way that protects the ecological integrity of the area.

This is done by preserving:

- adequate buffer zones around lakes, streams and wetlands
- old growth management areas
- wildlife trees (snags) to provide small animal and bird habitat
- wildlife corridors.

Sudden cold snaps (-25°C) in the early fall or late spring, or sustained frigid winter temperatures (less than -40°C) can also reduce beetle populations and help end serious outbreaks.

Mountain pine beetle-infested logs have some economic value if they are cut and processed within a couple of years of being attacked, although they are not as valuable as clean trees. The Ministry of Forests maintains tight controls on the transportation and milling of infested logs to ensure that the beetles are not being spread to new areas in the process.

General Beetle Management Strategies

Population growth is affected by many factors. For instance, the mountain pine beetle outbreak in the 1980s was a result of the legacy of mature and overmature lodgepole pine that was not logged commercially in the early part of the century, combined with favourable weather conditions which enabled the beetle populations to build up. The outbreak of spruce beetle, on the other hand, is influenced mainly by the amount of

susceptible material, such as windthrow. So don't draw any conclusions about the pests on your woodland until you have talked with the experts.

The best approach to protection is preventative stand management. For example:

- mountain pine beetle attack is related to tree vigour and maturity, and stands potentially at risk from this pest should be scheduled for harvest no later than about 80 years of age
- mountain pine beetle occurs more frequently in pure pine stands than in mixed stands, so another preventative management strategy involves the cultivation of stands with a mixture of species
- spruce beetle and Douglas-fir beetle thrive in windthrow and prompt attention to windfall and clean logging practices will reduce the likelihood of beetle buildup
- good slash disposal and the practice of logging to close utilization standards (30 cm stump height; 10 cm top diameter) has helped reduce the occurrence of Douglas-fir bark beetle
- often, bark beetles attack trees already weakened by other agents such as root rots or defoliating insects (e.g., Douglas-fir beetle often attacks mature Douglas-fir weakened by successive years of severe defoliation by Douglas-fir tussock moth); be on the lookout for potential problems.

More specific control measures such as trap trees and logs are used to control spruce beetle and mountain pine beetle. Since spruce beetle are naturally attracted to windthrown timber, trees are sometimes felled into the shade and bucked into logs to attract these pests. For mountain pine beetle, live, standing trees are baited with attractants. Once the pests have become established in a trap log or trap tree it is destroyed.

Managing the defoliating insects is likewise keyed to early detection and appraisal of the problem. Common prevention measures include thinning to control stand density, and managing stands for a diversity of species and age classes. Defoliators are also vulnerable to parasites, diseases and extreme temperatures. In addition, chemical and biological insecticides can be used to control and kill defoliators. Other methods of control, such as growth regulators, which interfere with the insect's life cycle, or sex attractants that interfere with breeding, are currently being researched.

Controlling Tree Diseases

Most attempts to control disease problems involve intensive forest management practices. Decay and rot are being fought by juvenile spacing and thinning which maintain the vigour of stands. Pruning the lower branches of young trees infected with white pine blister rust is carried out to intercept the rust's movement into the main stem from the branches. Mistletoe is treated by the selective removal of infected trees, or post-logging prescribed burning of the site to destroy any remaining infection spots in advanced regeneration or seedlings.

Root disease is tackled most often by crop replacement. When the *phellinus* root disease has been detected, the stand is usually harvested and planted with a rot-resistant species, such as cedar or pine. Since root disease may appear in pockets, rather than throughout a stand, it is often possible to stratify your planting, to plant less susceptible species in any identified disease pockets, and plant the desired species in the uninfected areas. After one rotation the area can often be replanted with the desired species. Alternatively, root disease can be treated by 'destumping' the area after harvest. This involves removing

stumps with an excavator after harvesting. Regional guidelines for detecting and treating infected areas are available from the district offices of the Ministry of Forests or the *Root Diseases Management Guidebook*.

What Else Can Damage My Forests?

In addition to the damage caused by fire, insects and disease, the health and productivity of woodlands can be affected by animals and machines. Porcupines, bears, squirrels, hares and a host of other unnamed creatures are also pests that plague a tree's well-being.

Animal-caused damage is most common to trees in the seedling stage, especially nursery-grown stock which resembles candy to wild and domestic grazing animals. The coastal areas of British Columbia, particularly the Gulf Islands, are plagued by deer browsing on newly planted seedlings. Porcupines are a current complaint on the north coast. In the interior, grazing and trampling by domestic livestock including cattle, sheep and horses, can be headaches to the woodland owner, and the Cariboo region currently has problems with rabbits. Many innovative, but expensive techniques for discouraging wild grazing animals have been tried, including the use of repellents (such as wolf urine), enclosing individual seedlings in mesh protectors, encouraging hunting, and erecting scarecrows and electric fences. As a general rule, livestock movement should be controlled by the distribution of salt licks, or fencing, to keep them out of newly planted areas.

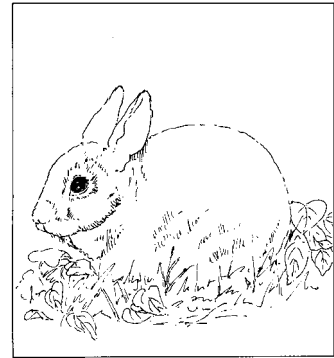

Mechanical damage usually occurs as a result of poor felling, skidding and road construction practices in which the main stems of standing trees are damaged. The bark is most vulnerable, and damage is the greatest, in spring during sap flow. In addition to the mechanical damage to the trees, damage to soil is a problem. Heavy equipment moving over a thin and fragile soil can lead to a breakdown of its internal structure. Soil compaction reduces soil drainage which can result in the puddling of water, and accelerate the erosion of soil in surface runoff. It can further reduce the productivity of the site by preventing revegetation, especially in heavy traffic areas such as landings. Damage can be minimized to an extent by careful planning and the layout of proper access roads.

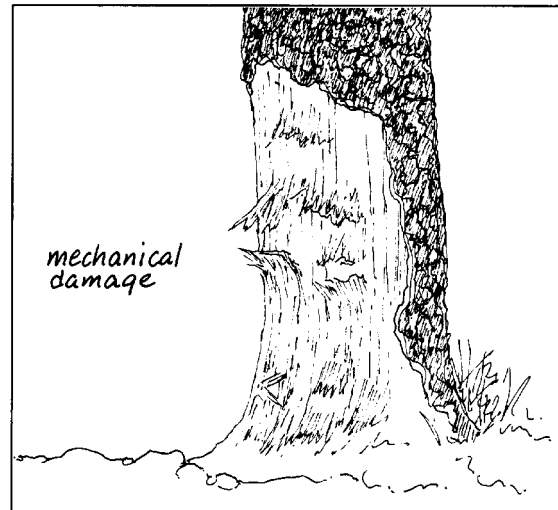

As forests become managed intensively for many uses, protection measures will be even more important, both to prevent damage related to increased use (e.g., snowmobiles) and to protect the woodland investment from risks of fire, insects and disease. Due to the personal nature of many small woodlands, protection will be a significant forest management activity. Your efforts will involve protecting your woodland from needless

damage by the forces you control and minimizing the risks to it from the forces you can't control.

In recent decades, *weather and environment issues* have presented new problems. Agents such as acid rain and other forms of pollution have caused a new stress to forests throughout the world. In British Columbia, however storms, winter kill, frost, snow press and drought are more immediate causes of stand damage.

Recommended References

Small Woodlands Program of BC

A comprehensive 'Small Woodlands Library' is available on the web [www.swp.bc.ca]

BC Ministry of Forests – Forest Practices Code Guidebooks:

Beetle Management Guidebook

Defoliator Management Guidebook

Dwarf Mistletoe Management Guidebook

Forest Health Surveys Guidebook,

Root Disease Management Guidebook

Forest Fire Prevention Regulation. 1979. BC Reg. 557fl8

The Forest Fire A Basic Guide to Fire Behaviour and Suppression

Forest Protection Handbooks and Student Workbooks

Forest Diseases and Forest Management. 1985

Pest Topics. Pest information sheets. Protection Branch

Pest Management Progress. Biannual newsletter Protection Branch

Protection Manual. Protection Branch

Regional Guidelines for Pest Detection and Control Methods. District Offices

Whitehead, R.J., P. Martin and A. Powelson, 2001. *Reducing stand and landscape susceptibility to mountain pine beetle.* British Columbia Ministry of Forests, Victoria, BC.

Crown Publications Inc, Victoria

Forest Act. 1979

Canadian Forest Service

Commercial thinning of mature lodgepole pine: Results of "beetle proofing" research in the East Kootenays. 2001. (Brochure)

Cone and Seed Insects of British Columbia. BC-X-90

Forest Pest Leaflet. Available for approximately 70 forest pests.

Foliar Fungi of Western Trees. 1985. A. Funk. BC-X-265

The effects of prescribed burning on mountain pine beetle in lodgepole pine. BC-X-391

Line transect sampling to estimate the density of lodgepole pine currently attacked by mountain pine beetle. BC-X-392

Common Tree Diseases of British Columbia. 1996

USDA Forest Service

Insects and Diseases of Alaskan Forests. 1985. Alaska Region Report. No.181

Forest Disease Management Notes. 1983. Pacific Northwest Region

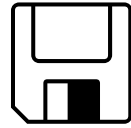

Business Basics

Business Planning

In this chapter...

What Kind of Business Is This?	249
What Business Structure Do I Need?	250
What Else Do I Need to Organize to Set Up a Business?	251
Do I Need A Business Plan?	252
What Is A Business Plan?	252
Recommended References	253

.....

What Kind of Business Is This?

Managing a woodland can be a complex business, and its success depends on the owner's understanding of the financial requirements and potential returns of the tasks he/she undertakes. With careful planning and decision making, a small woodland can provide financial and many other benefits to the operator, now and in the future.

This chapter provides the basic business considerations for a small woodland operation. For more information refer to the Small Woodlands Program *Business Planning and Marketing Guidebook*.

Forest management is a long-term venture which yields generally modest and intermittent profits. The investments to finance activities such as tree planting, juvenile spacing, road development and forest protection are tied up for long periods while the trees grow. Only when logs or other forest products are harvested and sold are revenues produced. In the short term there may not be enough product revenues to cover the early costs of managing the forest. In many cases, the financial resources to support the management activities of the small-scale woodland (and the family that owns it!) will come from another source than the woodland itself.

Many of you will manage your lands as a small business for the production of timber products, while enhancing other resource values such as range management, recreation or wildlife habitat. A number of assistance and extension programs are available to help you with these tasks (see the chapter "Information Resources"). These, combined with careful planning and elbow grease, can provide the necessary resources for a successful woodland operation.

What Business Structure Do I Need?

At this point in your planning process, you may be wondering what type of business entity makes most sense—a sole proprietorship, a partnership, or a corporation.

A *sole proprietorship* is a single person who performs most of the duties required to operate the business. It is a simple, informal and inexpensive business form but has various disadvantages such as unlimited personal liabilities and the progressive rate of personal income tax applies. A *partnership* is somewhat more formal as a sole proprietorship but has still the cons of progressive rates of personal income tax and unlimited liabilities.

A *corporation* is much more structured and formal. Normally, you have to face legal costs for setting up and maintaining the business. On the other hand, small incorporated businesses face a lower tax rate and they have a limited liability which somewhat protects the owner. You also gain a more professional business appearance that is often important for banks, or other lending institution. For an appropriate business structure you also want to talk to your lawyer and/or accountant.

What Else Do I Need to Organize to Set Up a Business?

Business Registration – Once you have decided about the formal structure of your business, you have to apply for a business name and register your company. This can be done at the BC Access Centre (Government Agent) or on-line or through your lawyer.

Payroll, GST, PST – If you hire employees (including you and your family) or if you want to register for GST, you have to apply for a business/GST number with Canada Customs and Revenue Agency (CCRA). The registration for GST is only needed if your annual sales exceed \$30,000. You also have to check if you have to register as a vendor to remit Provincial Sales Tax (PST) or if you are entitled to exemption from PST (e.g., landowners who have Farm Classification are entitled to be exempt from PST on many of their inputs used on the farm).

Import/Export – if you intend to export timber, you also need to register through CCRA.

Workers' Compensation Board (WCB) registration – You are required to register your company for WCB coverage. Your employees, you and any subcontractor working for you will be covered under your insurance. Your payment will depend on your category, your wages, dividends and subcontractor earnings. Under normal circumstance you don't want to pay the WCB rate for your subcontractors. So, make sure that your subcontractors have their own WCB number and that they are in good standing (meaning that they have paid their dues). You can check this by phoning WCB (1-888-922-2768) or check on-line (www.worksafebc.com).

Insurances – Make sure that you include your new business in your insurance policies and that you explain your new business activities to the insurance agent.

Set up of books, records and filing – Do not throw everything in one box. This might look like an easy solution in the beginning but will hound you afterwards. Let a bookkeeper help you to set up the initial structure. This will save you later accountant's fees. Try to keep your books and records up to date on a quarterly or monthly basis. A typical filing system for woodland operators might be structured like this:
correspondence, legal documents,
inventory and management plans,
technical data and surveys, accounting records.

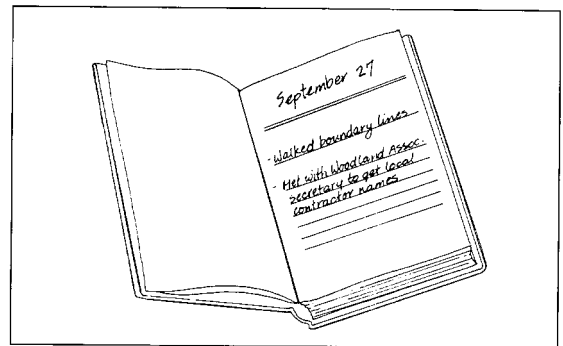

Do I Need A Business Plan?

If you're like most of us, and you don't have a lot of money to invest in the management of your woodland, or if the woodland is 'just a bunch of trees' that you want to cut for firewood, a few poles, and maybe some extra cash at Christmas, or if you have never planned (or perhaps stuck to) a budget, you're probably asking yourself if you really need a Business Plan for your woodland. The answer is yes. Here are some of the reasons why:

- It encourages you to be realistic in planning activities.
- It helps you to identify markets and customers, to determine a fair price for your products.
- Putting your plans on paper forces you to look at the decisions you are making and gives you the chance to identify and address problems before or soon after they appear.
- The Business Plan sets out the amount, source and timing of the financing required to carry out the forest management activities proposed in the Forest Management Plan.
- The Business Plan makes it easier for outside parties to assess your financing requirements or other requests for assistance. It is a clear statement of the resources required to meet your goals.

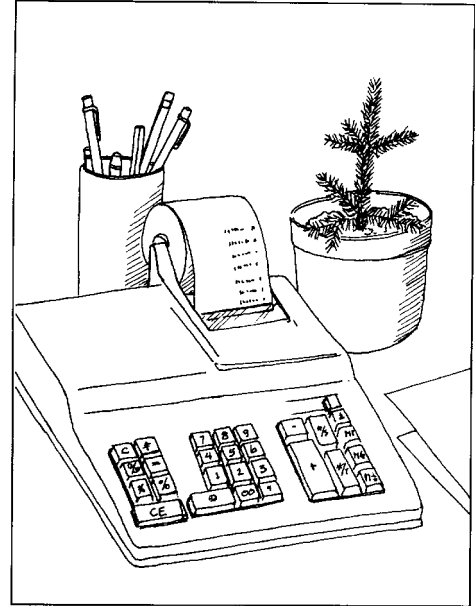

What Is A Business Plan?

The Business Plan is a financial statement of your Forest Management Plan. It sets out a budget for your operations based on the revenues you anticipate from the products you plan to produce, and the costs you expect to pay in the process of producing them. It also identifies the capital requirements you will need to carry out your forestry operations, when they are needed, and from where you plan to get the money.

Refer to the Small Woodlands Program *Business Planning and Marketing Guidebook* for a sample Business Plan as well as a Business Plan Guide and a template. You can also find templates on-line or as copies from most financial institutions, the Business Development Bank, and the Community Futures Development associations.

Recommended References

Small Woodlands Program of BC

A comprehensive 'Small Woodlands Library' is available on the web [www.swp.bc.ca]

Small Woodlands Program of BC, 2002. *Business Planning and Marketing Guidebook*,

tel.: 1-877-8471830

[www.swp.bc.ca]

Canada/British Columbia Business Services

Interactive business planner, one-stop business registration

601 West Cordova Street, Vancouver, BC, V6B 1G1, tel.: 1-800-667-2272

[www.smallbusinessbc.ca]

Workers' Compensation Board (WCB)

[www.worksafebc.com]

Business Development Bank Canada

[www.bdc.ca]

Community Futures Development Association of BC

[www.communityfutures.ca]

Canada Customs and Revenue Agency

tel.: 1-800-959-5525

James, Jack. 1995. *Incorporation and Business Guide for BC*, Self-Counsel Press, North

Vancouver, BC, tel.: 1-800-663-3007 or

[www.self-counsel.com]

Province of British Columbia. 1995. *Resource Guide for BC Businesses*. Ministry of Small Business, Tourism, and Culture.

Western Economic Diversification

tel.: 1-800-667-2272 or wd.satelliteoffice@cbsc.ic.gc.ca.

Oregon State University Woodland Workbook.

Forestry Financial Analysis I: An Introduction to Landowners

Forestry Financial Analysis II: Worksheets for How to Do it

Record Keeping: A How to Do it Guide for Small Woodland Owners

Publication Orders, Extension and Communications, Oregon State Univer.,

422 Kerr Administration, Corvallis, OR 97331-2119, fax. 541-737-0817.

[www.orst.edu]

Bank of Montreal, *Business Planning*

[www.bmo.com/business/p/starting.html]

Small Business Planning Centre

[<http://www.bplans.com>]

Summary of Federal programs

[www.rural.gc.ca/pocket]

Oregon State University Extension Service

Forestry Financial Analysis II: Worksheets for How-to-Do-It, Extension Circular 1147

Forestry Financial Analysis III: How to Compare Two (or More) Investments, Extension

Circular 1148, [www.orst.edu]

Washington State University

[<http://pubs.wsu.edu>]

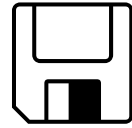

Introduction to Taxation

Business Planning

In this chapter...

Tax Planning	256
Property Taxes	257
Resource Taxes	257
Sales Taxes	258
Income Taxes	259
Estate and Succession Tax Planning	260
Recommended References	261

.....

Tax Planning

This chapter describes some of the taxation issues relevant to woodland operations on private land. Because tax planning is such an important part of operating a woodland business, and can be complex, you should not use this chapter to replace the advice of an accountant, tax specialist or Registered Professional Forester (RPF) familiar with woodland taxation.

The list below provides suggestions for basic tax planning that will help minimize the impact of taxes on your business:

Know your responsibilities – Learn about your municipal, provincial and federal tax obligations.

Assess where you are – Are you meeting legal tax requirements? Do you need professional advice? Are there areas where you could do better?

Set goals – Investigate ways to reduce your tax obligations.

Develop strategies to achieve your tax goals –

For example, to reduce or minimize taxes, you could consider a number of strategies: income splitting with family members, use of bonuses, shareholder loans, the small business tax rate, dividend payments, tax loss carryovers, and changing property classification status.

Enlist the services of an accountant and an RPF familiar with small woodlands operations – With these specialists, develop a plan to minimize taxes and meet legal requirements.

Maintain your record keeping system – Separate your business records from your personal records. Open a business bank account. Keep all receipts and records for business related activities. Keeping books current will help prove to the CCRA that the woodland business is not a hobby. Up-to-date accounts will also tell you how well your business is doing and you will have complete financial records for calculating GST and income taxes.

Write a Business Plan – A Business Plan will help convince CCRA that your woodland operation is a business and has a *reasonable expectation of making a profit*.

There are four categories of taxes of interest to woodland owners:

1. Property taxes
2. Resource taxes
3. Sales taxes
4. Income taxes, including capital gains and succession taxation.



Property Taxes

Private land in BC is classified into different categories for property tax purposes.

The following four apply to private woodland properties:

- Managed forest land
- Unmanaged forest land
- Residential land
- Farm land.

In general, BC Assessment (BCA) assesses and classifies land for property tax purposes. The exception is the Managed Forest Land classification, which is now granted by the Land Reserve Commission (LRC).

The table that follows illustrates how various regulations, restrictions and taxes apply to the different assessment classes.

[See the SWP Business Planning and Marketing Guidebook for details on Agricultural Land Reserve and Forest Land Reserve (FLR) classifications.]

Assessment class	Development restrictions	Right to farm/forest	Timber taxed	Forest Practices Regulations	Property tax
Managed Forest	Yes	Yes	Yes	Yes	
Unmanaged Forest	No	No	Yes	No (unless in FLR)	
Residential	No				
Farm	Only if in ALR	Yes	No	No	Lowest

Your tax assessment notice indicates your land classification. Apply to the BCA if you wish to obtain reclassification into a more favourable category.

Resource Taxes

Stumpage Fees on Private Property

Stumpage is the rent or return to the landowner from the harvesting of timber from the land. Simply put, it is the net income from selling logs after deducting harvesting and access costs.

In BC, the term ‘stumpage’ is generally associated with Crown land and is essentially a rent paid to the Crown in return for the right to harvest timber on public land.

It is very rare for private landowners to pay stumpage fees to the Crown. The exception is on private land that does not include surface rights. In this case, the landowner may have to pay stumpage to the owner of the surface rights. If you are unsure of the status of your land title, check the title or contact your nearest Land Title Office.

BC Logging Tax

Each individual or corporation that engages in logging operations on private or Crown land in BC is responsible for filing an annual logging tax return with the Income Taxation Branch.

[See the SWP Business Planning and Marketing Guidebook for details on filing and calculation.]

Logging operations include the following:

- the sale of logs or standing timber
- the sale of the right to cut standing timber
- the sale of primary and secondary forest products produced from logs such as
- lumber, pulp and paper, and shakes
- the export of logs.

Logging tax returns, along with a copy of the taxpayer's federal income tax return and financial statements, must be filed within six months of the end of the taxation year in which logging operations occurred. If logging operations cease, notify the Commissioner of Income Tax in writing.

Non-timber Forest Products

Currently, there are no direct taxes arising from the harvesting of non-timber forest products in BC. There are no government imposed fees or taxation on either public or private lands for wild mushrooms, berries, floral greenery, medicinal plants and boughs. However, there are certainly situations in which private landowners can, and should, charge people to harvest non-timber forest products on their woodlands.

Sales Taxes

Goods and Services Tax (GST)

If your annual sales exceed \$30,000, you are required to register for GST and collect it. The net amount of GST collected must be remitted to CCRA on a regular basis (monthly, quarterly or annually depending on the amount of sales). Net GST is calculated by deducting the GST paid on inputs (input tax credits are the amount of GST paid on business expenses) from the total GST collected.

[See of the SWP Business Planning and Marketing Guidebook for GST registration information.]

If your annual sales are less than \$30,000, GST registration is not required. It may still be worthwhile registering if you are mainly producing food crops. These are generally 'zero based,' allowing you to recover most of the GST paid out on your business operation.

Provincial Sales Tax (PST)

Land owners who have Farm Classification are entitled to exemption from PST on many of the inputs used on the farm. There are two ways to obtain an exemption:

1. Obtain a Farmer Identification Card from the BC Agricultural Council
2. Fill out a Certificate of Exemption. Many merchants, especially farm supply

outlets, will have copies.

The folio number from your tax assessment is needed to prove you are a *bona fide* farmer for the purposes of PST exemption. The Consumer Taxation Branch of the Ministry of Finance has developed an extensive list of exempt inputs. Note that not all inputs used on a farm are exempt. For example, PST on a tractor tire is exempt, while PST on a computer is not.

Manufacturers who regularly make retail sales (defined in the Act as sale for the purchaser's consumption or use and not for resale) must be registered as vendors with the Consumer Taxation Branch.

[See the SWP Business Planning and Marketing Guidebook.]

Income Taxes

If you own forest land you should be aware of how your forestry activities influence your income tax status. As profits increase, so does the potential for income taxes. As a result, it is worthwhile to look at ways to minimize your taxes. The Canada Customs and Revenue Agency (CCRA) has rules concerning how expenses and income are handled on your tax return when they apply to those forestry activities that are carried out with a

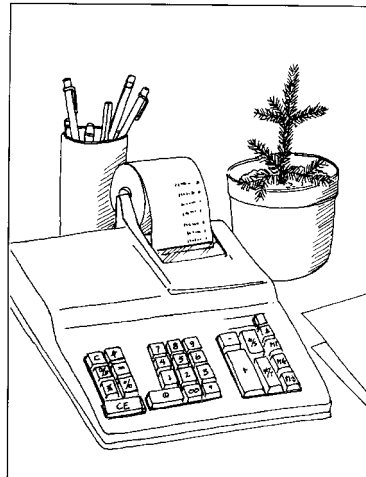

'reasonable expectation of profit.' In general, farmers have the most tax planning options available, and 'hobby woodlot' owners the least. For taxation purposes, it makes sense to steer your land designation toward the most beneficial classification.

This section can only highlight some of the relevant parts of income tax law and interpretations related to woodland operations. Be aware that the *Income Tax Act* changes yearly and interpretation of the Act is subject constant change and challenge.

The Canada Customs and Revenue Agency may challenge your claims, so you should be comfortable with your tax strategy and be prepared to defend your claims.

To begin your tax planning:

1. Collect the latest information and interpretations relevant to income taxation on your property.
2. Review the information carefully to see how the tax rulings affect you, and to prepare to meet with your accountant.
3. Consult an accountant familiar with taxation of woodland businesses.

The CCRA Interpretation Bulletin IT – 373R2 (Subject: *Income Tax Act – Woodlots*) probably provides the most relevant information for income tax planning.

[See the SWP Business Planning and Marketing Guidebook or www.c CRA-adrc.gc.ca].

The flowchart above summarizes the three-step process outlined in IT – 373R2 for determining income tax rules that apply to your woodlands.

Estate and Succession Tax Planning

Estate and/or succession planning is important to ensure the orderly transfer of property or business upon the owner's death. A well thought out estate plan will minimize the impact on the business and ensure that those left behind are able to manage estate-related taxes. Generally, the owner will be deemed to have disposed of the property for its fair market value as of the date of death. If there is a capital gain, the estate may be faced with a tax liability.

One common tax strategy is to transfer the woodland ownership to a spouse. If the woodland is transferred to a spouse, the transfer occurs at the owner's adjusted cost base, and the spouse simply assumes the owner's tax position. Income gains from the property during the owner's lifetime will be taxed to the owner, not the spouse. However, if the owner transfers the woodland to a child, grandchild, parent, sister or brother, the owner is deemed to have disposed of the property at fair market value. An appraisal of property value can be done with a timber cruise, which can provide an independent third party viewpoint for any discussions with CCRA.

There is an exception to this introduced in the December 2001 federal mini budget where woodland owners will now be eligible for the same tax relief as farmers on intergenerational transfers of properties providing that there is a Management Plan in place and they can provide evidence that the woodland actively managed. Contact CCRA for more information on this option.

The best way to ensure that you have an effective plan in place to minimize your succession taxes is to meet with an accountant, lawyer and forester to develop a proper estate plan. Ensure, at the very minimum, that your will is up to date.

The following is an illustration of three main issues that must be resolved in order to determine the income tax rules that will apply to you.

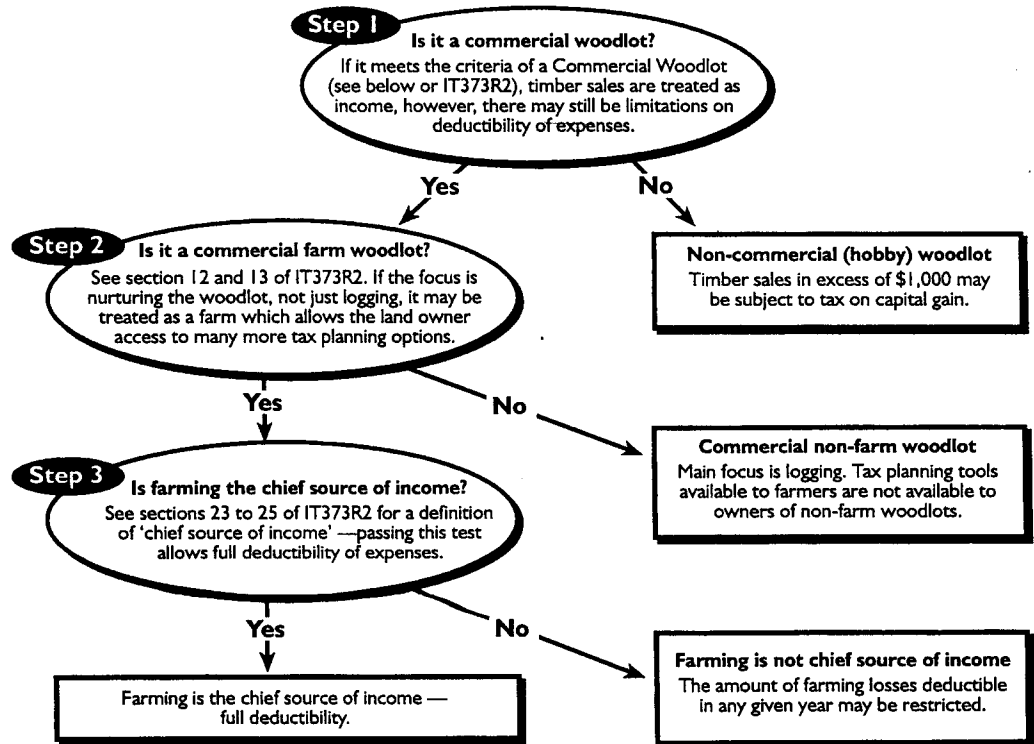

Recommended References

Small Woodlands Program of BC

A comprehensive 'Small Woodlands Library' is available on the web [www.swp.bc.ca]

Small Woodlands Program of BC, 2002. *Business Planning and Marketing Guidebook*,

Appendix 2, 17, 18, 19

[www.swp.bc.ca]

Canada/British Columbia Business Service Centre

[www.smallbusinessbc.ca]

Canada Customs and Revenue Agency (CCRA)

– IT-322R, *Income Tax Act* Farm Losses

– IT-373R2, Woodlot Owners

– IT-322R2, *Income Tax Act*, Non-Capital Losses, Net Capital Losses

– *Business and Professional Income Guide* T4002(E),

Interpretive Bulletins and Guides are available as publications at tel.: 1-800-959-5525

[www.cca-adrc.gc.ca]

BC Assessment Authority,

BC Ministry of Municipal Affairs, Municipal Financial Services in Victoria

tel.: 250-387-4060.

[www.bcassessment.bc.ca/6_agfo/6_agfo.html]

Crown Publications, *The Logging Tax Act*, 521 Fort Street, Victoria, British Columbia,

V8W 1E7, tel.: 250-386-4636

Ministry of Finance and Corporate Relations, *Logging Tax Act*, Income and Resource Tax

Section, Income Taxation Branch,

PO Box 9434 Stn Prov Govt, Victoria, BC V8W 9V3, tel: 250-387-0616

[www.rev.gov.bc.ca/itb/log/log_outline.htm]

Peat Marwick Thorne, 1993. *Taxation and the BC Farmer*,

BC Ministry of Agriculture and Food.

Doane, Raymond. 1996. *Income Tax Guide for Woodlot Owners*. New Brunswick Department of

Natural Resources and Energy, Forest Extension Service, Fredericton, NB.

Lunergan Professional Corporation. 1998. *Income Taxes and Woodlot Management*. New

Brunswick Federation of Woodlot Owners.

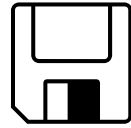

Forest Legislation

Forest Legislation

In this chapter...

What Legislation Applies to My Land?	263
Federal Legislation	264
Provincial Legislation	266
Local Legislation	270
Recommended References	271

.....

What Legislation Applies to My Land?

In British Columbia, there is federal, provincial and municipal legislation that can apply to private land.

Federal legislation generally applies to federal Crown land, Indian Reserves and to provincial Crown land and in certain circumstances to private land. Federal legislation generally covers inter jurisdictional issues such as species at risk, navigable waters and fisheries, exports and imports, and transportation of dangerous goods, and taxation.

Provincial legislation generally distinguishes between private land and Crown land, and between private land that is in the Forest Land Reserve and land that is not. Provincial legislation covers a range of topics including environmental standards, forest management, fisheries and wildlife, employment standards and workplace safety, assessment and taxation. Most provincial *Forest Act* and *Forest Practices Code of British Columbia Act* legislation is not applicable to private land.

Municipal bylaws generally govern private property within the jurisdiction of local government.

In some cases private land may carry restrictions on activities through zoning, covenants, bylaws, easements or surface rights. It is possible that the timber rights are not included, or that there are easements or covenants which would conflict with your plans for woodland management. Information about what rights are included or excluded in the ownership of your land can be obtained from the Land Titles Office or your government agent.

It is your responsibility to know what legislation and regulations apply to you and your land before you commence any management activities. This chapter provides an overview of the legislation affecting private woodlands in BC and since law is dynamic and always evolving, you are advised to educate and update yourself on an ongoing basis. Contact your local government agencies as well as representatives from your regional district or municipality if you are in doubt about which laws you have to follow.

Federal Legislation

Federal legislation is available online at: <http://canada.justice.gc.ca/en/laws/>

Canadian Environmental Assessment Act, S.C. 1992, c.37

Applies to harvesting on Indian Reserve lands and may apply if the federal government has any involvement with management (e.g., by providing financial assistance or providing permits or approvals).

Export and Import Permits Act

Under the authority of the *Export and Import Permits Act*, the issuance of Export Permits is administered by the Export Control Division of the Department of Foreign Affairs and International Trade. The Division provides assistance to exporters in determining if export permits are required. It also publishes brochures and Notices to Exporters that are

freely available on request. Since not all private land is equal in this regard you need to make sure that the timber from your land is exportable.

Explosives Act and Regulation

The *Explosives Act* and Regulation controls the storage and handling of explosives, which you might need to build your woodland road through some rock, or to develop a rock pit for ballasting material. The Explosives Branch of Natural Resources Canada is distributing a small brochure, outlining the requirements regarding explosives.

Fisheries Act R.S.C. 1985, c. F-14

Most woodland managers will have to consider how to operate near fish habitat, which could be streams, lakes, wetlands or fisheries sensitive zones (areas that are seasonally flooded and that are important as temporary retreat for some fish species). The *Fisheries Act* prohibits in section 35, *any work or undertaking that results in the harmful alteration, disruption or destruction of fish habitat*. Since most federal and provincial fisheries officials would not accept any habitat impact through you woodland operation after the fact, it is best to get their advice before you fell trees and cross streams. Depending on the particular situation, usually there are methods to avoid or to minimize logging impacts on fish habitat.

Indian Act, R.S.C. 1985, c-15.

Indian Timber Regulations apply to forest management on Indian Reserve lands.

Migratory Birds Convention Act, 1994, S.C. 1994, c.22.

Enables the Convention on the Protection of Migratory Birds in Canada and the United States. Section 6(a) of the *Migratory Bird Regulations* makes it an offence to disturb, destroy or take a nest or egg of a migratory bird without a permit. This can have implications for the timing of woodland operations during nesting season.

Pest Control Products Act, R.S.C. 1985, c. P-9.

Addresses the labelling and use of pesticides. This Act is supplemented by the provincial *Pesticide Control Act* which specifies detailed requirements for the use of pesticides.

Plant Protection Act, S.C. 1990, c.22.

The purpose of this Act is to protect plant life and the agricultural and forestry sectors of the Canadian economy by preventing the importation, exportation and spread of pests by controlling and eradicating pests in Canada. Landowners who wish to import exotic seeds or plant material need to be aware of this legislation (as well as the *Wild Animal and Plant Protection and Regulation of International and Interprovincial Trade Act*). This legislation will also apply if a forest becomes infested with certain insect pests allowing the government to either order or take necessary action to control an outbreak or infestation (e.g., recent cutting of trees in a downtown Halifax Park that had become infested with an invasive bark beetle).

Species at Risk Act

The *Species at Risk Act* defines the process of listing species at risk and of protecting critical habitat of those species on Crown **and** private land. This legislation is very recent and the question of compensation of a land owner who happens to have critical habitat on his property is not entirely clear.

Provincial Legislation

Provincial Statutes are available online at: www.qp.gov.bc.ca/bcstats/index.htm

Assessment Act, R.S.B.C. 1996, c.20

Provides for taxation assessment classes (e.g., Managed Forest Land) and the applicable framework for forest management on untenured private land, including the requirement for a management plan.

Employment Standards Act, R.S.B.C. 1996, c.113

May apply to a forest landowner if they you are hiring and maintaining employees. Refer to *Employment Standards Regulations* for full details.

Forest Act, R.S.B.C. 1996, c.157

The *Forest Act* applies primarily to Crown land and so is largely not applicable to private woodlands. However some provisions may apply. The *Forest Act* prohibits the export of unmanufactured timber products from Crown land **and** from land granted by the government after March 12, 1906. It could be possible that your woodland originated from those late Crown grants.

The *Forest Act* further establishes the requirement of timber marking and scaling of timber from Crown **and** private land. The *Timber Marking and Transportation Regulation* further clarifies the responsibility for accurate completion, retention and submission of transportation documents. Contact your Ministry of Forests district office to apply for a timber mark for your woodland. The staff can also provide you with further details on the marking, transportation, scaling and documentation requirements.

Transporting wood on public roads requires you to have documentation for the type and origin of the wood, even if it is your own! If you let a neighbour cut and take home firewood from your woodland, you should arrange for him to have a firewood permit or similar document. This document should contain information about source and destination of the wood, what kind and amount of wood it is, who owns and who gets it as well as what precautions are to be taken while on your woodlands (e.g., removal of debris, no cutting of standing trees, no spilling or leaving of garbage and keeping of all necessary safety and fire tools). Ask

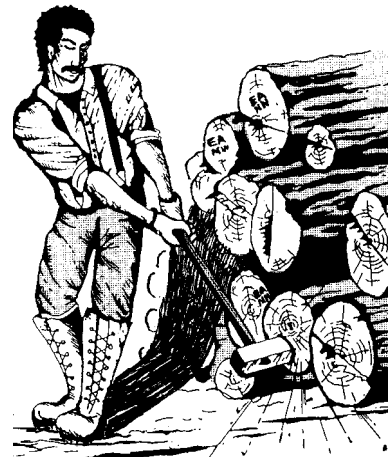

your local Ministry of Forests office for a fire permit form, which you can adapt for your own purpose.

Forest Land Reserve Act, R.S.B.C. 1996, c.158

Part of the legal framework for forest management on untenured private land. The *Private Land Forest Practices Regulation* applies to forest reserve land and agricultural reserve land that is classified as managed forest land and addresses forest management activities in the vicinity of riparian areas as well as soil conservation.

Forest Practices Code of British Columbia Act R.S.B.C. 1996, c.159

Most provisions of the *Forest Practices Code of British Columbia Act* do not apply to private land. However, there are exceptions. The *Forest Practices Code of British Columbia Act* details obligations for fire prevention, control and suppression that are applicable to private landowner. You must also report forest fires, fight any fires that you or your employees have started and you can be recruited to fight other fires. The *Forest Fire Prevention and Suppression Regulation* further details the type and amount of equipment you need to carry, the requirement to obtain a burning reference number for slash burning and the work time and fire watch schedule during fire season.



You are required to ensure that you are not trespassing on Crown land and damage Crown timber. The *Forest Practices Code of BC Act* is very clear that it is your obligation as the landowner to inform yourself and anyone authorized by you of the boundaries of your land. In practice, this means that the logging boundary is clearly marked (spray paint and flagging tape) so that there could be no error.

Section 106 of the *Forest Practices Code of BC Act* authorises the Ministry of Forests to order you to control diseases, insects, animals or abiotic factors (windthrow, water, etc.) on your woodland.

Highways Act

When you are constructing road access in your woodland to develop new harvesting areas you are required to get a permit for each new junction with a public road from the Ministry of Transportation and Highways. The permit for access to highways is issued under the *Highway Act* and specifies what signs are to be installed (stop sign, logging truck symbol) and what kind of culvert to be used for crossing the highway ditch.

The *Highway Act* further regulates the maximum axle weight of logging trucks on public highways and seasonal or permanent load restrictions on certain routes. Contact your local Ministry of Transportation office for more information regarding local restrictions.

Land Reserve Commission Act, S.B.C. 1999, c.14

Enables the land reserve commission whose responsibility is to maintain and restrict the use of land within the forest or agricultural land reserve. Part of the legal framework for forest management on untenured private land.

Logging Tax Act, R.S.B.C. 1996, c277

Applies to taxes payable on income derived from logging operations in BC.

Occupiers Liability Act, R.S.B.C. 1996, c337

The *Occupiers' Liability Act* states that you as the occupier of your woodland have to ensure that persons will be reasonably safe in using your woodland. It also states that someone entering farm or forest land for the purpose of recreation or trespassing is not covered by the occupiers liability. You are usually not liable for the negligence of independent contractors working in your woodland. However, you need to make sure that private roads and recreation trails are marked as such and that you are not creating or contributing to hazards (e.g., omitting to post warning signs before your falling areas, leaving holes unsecured)

Pesticide Control Act, R.S.B.C. 1996, c360.

If you intend to use pesticides on your woodland, for instance, to control weeds or insects or to apply 'hack & squirt' to hardwoods, you need to be certified to apply pesticides (Forest Pesticide Applicator Permit). According to the *Pesticide Control Act* you also need to have a permit or approved pest management plan before applying the pesticide. The application for such permit to the Ministry of Water Land and Air Protection usually involves advertising and a public review period.

Plant Protection Act, R.S.B.C. 1996, c365.

Relates to the prevention of deleterious spreading of pests or diseases harmful to plants including the Balsam Woolly Adelgid. Does not apply to matters specifically regulated under the federal *Plant Protection Act*.

Soil Conservation Act, R.S.B.C. 1996, c.434.

The *Soil Conservation Act* is intended to protect soil on land in an agricultural land reserve (ALR) by regulating its removal and the placement of fill. The process requires that the Land Reserve Commission provide written approval and the local authority must issue a permit.

Trespass Act

The *Trespass Act* defines, that your land needs to be fenced, or to be surrounded by a natural boundary or otherwise prohibiting trespass signs need to be posted at each ordinary access, in order to count as 'enclosed land.' If your woodland qualifies as such, someone entering without your permission is trespassing and committing an offence. You have the right to demand the name and address from trespassers.

This legislation is important, to protect your woodland from illegal firewood cutters, vandalism and theft of wood or non-timber first products.

You also have a duty to avoid harvest trespassing on adjacent land—one of the most common issues that arises when logging or road building near property boundaries. The Land Title Office can provide you with the legal surveys and legal plans that exist for your land. Since trespassing is a serious offence under provincial law you need to make sure of where the boundaries are, before you operate in the proximity of them. The best ‘low cost’ solution is to walk the boundary with your neighbour and to get a signed confirmation that you both agree on the viewed boundary location. If this is not possible, have a legal surveyor find and mark the boundary line.

Water Act, R.S.B.C. 1996, c.483

Among other things, applies to persons making changes in or about streams, requiring that they must ensure that no substance, sediment, debris or material that could adversely impact the stream is allowed or permitted to enter the stream, and that there is no unauthorized disturbance or removal of stable natural material and vegetation that contribute to stream channel stability. The *Water Act* also legislates the process for the establishment of community watersheds and water licences. Inquire at your local ministries about whether your woodland is within a community watershed and what restrictions might apply to your operations.

Waste Management Act, R.S.B.C. 1996, c.482

The *Waste Management Act* requires you to prevent and report spills of ‘polluting substances,’ which can include the fuel and oil you use in your woodland, pesticides, antifreeze, fertilizer, sewage, or smoke from burning. Your duty for preventing spills includes that you have a contingency plan (part of your safety or emergency plan) and spill kits in your large machines. Pre-packaged environmental spill kits are available at forestry supply stores or you can assemble your own. If you have a stationary fuel tank you need to install impermeable spill containment dykes that can hold the entire volume of your tank. In some cases, i.e., burning you may require a permit and approval before you are allowed to burn (consult the *Open Burning Smoke Control Regulation*, and *Wood Residue Burner and Incinerator Regulation*.)

Wildlife Act, R.S.B.C. 1996, c.488

The *Wildlife Act* prohibits you to disturb or destroy a muskrat or beaver den unless you have a permit. The nests of specified large raptors are also protected under this act including: eagles, peregrine falcons, gyrfalcons, ospreys, herons and burrowing owl. Make sure that you have located any of those nests on your woodland before you start logging. Consult your local wildlife officer if you are in doubt what kind of nest you have on your land.

The nests of all birds are protected under the *Wildlife Act*, if they are occupied by a bird or its egg. This is particular important in springtime, where there are many small nests that you could miss. The Ministry of Water Land and Air Protection recommends to avoid land clearings and timber harvesting during peak nesting season from April 1st to August 1st. See also Federal *Migratory Bird Regulations*.

Workers' Compensation Board Act, R.S.B.C. 1996, c.492

Under this act the Workers' Compensation Board (WCB) and the *Occupational Health and Safety Regulations* are legislated. Besides the obligation to register your company with WCB, you are required to take several mandatory steps to reduce the risk of accidents. Before you head out with your employees to work on your woodland, you need to prepare an emergency/safety plan, that details the procedures, contact numbers, means and line of communication and a backup plan if all else fails. Someone in your crew needs to be appointed the first aid attendant with the proper certificate and you need to have the necessary first aid equipment.

WCB regulations require you to have proper training when you are falling trees. Ask your local WCB representative about faller certification courses. As an employer you need to have written procedures for falling operations. In any of your woodland operations you are required to have regular safety meetings and reports. Before starting on the work site you need to notify WCB about the location. If someone gets hurt you are required as an employer to report even small accidents to WCB. Your local WCB office will be happy to provide you with their forms and report templates, but also with their excellent selection of educational material.



Woodworkers Lien Act, R.S.B.C. 1996, c.491

A person performing labour or services in connection with logs or timber in British Columbia, or his assignee, has a lien on them for the amount due for the labour or services.

Local Legislation

Local municipalities, regional districts, Island Trusts sometimes pass bylaws that regulate the cutting of trees to protect significant trees (size, species), riparian (streamside) vegetation, or to protect greenways and other local features. Often you will need a development permit before you start harvesting or modifying your land if you are located within a particular area. In some cases there may be covenants held by the local land trusts that can prohibit all or some cutting of trees. It is your obligation to find out about these laws that govern the area of your woodland. Contact your local municipality, regional district, landtrust for information about any local bylaws.

Recommended References

Small Woodlands Program of BC

A comprehensive 'Small Woodlands Library' is available on the web [www.swp.bc.ca]

Ministry of Forests. Brochures and Publications. Production Resources, 4th Floor - 722 Johnson Street, PO Box 9523, Stn. Prov. Gov., Victoria BC V8W 9C2, [www.for.gov.bc.ca/hfd/pubs/Index.htm]

Workers' Compensation Board. Safety regulations and education material. P.O. Box 5350, Vancouver, BC, V6B 5L5, tel.:1-800-661-2112, fax: 604-276-3247, [www.worksafebc.com]

Crown Publication Inc. Federal and Provincial Legislation.

521 Fort Street, Victoria, B.C. V8W 1E7, tel.:250-386-4636, fax 250-386-0221, [www.crownpub.bc.ca], On-line legislation research tool [www.qplegaleze.ca]

Queen's Printer, Federal and Provincial Legislation, tel.:250-356-5850, [www.qp.gov.bc.ca]

Export Control Division of the Department of Foreign Affairs and International Trade,

Export permits.Tower C, 4th Floor, L.B.Pearson Bldg., 125 Sussex Drive, Ottawa, Ontario, K1A 0G2, tel.: 613-944-2167, fax 613-944-2170, [www.dfait-maeci.gc.ca/~eicb/epd_home.htm]

Natural Resources Canada, Blasting Explosives and Detonators - Storage, Possession, Transportation, Destruction and Sale. Explosives Branch, 15th floor, 580 Booth Street, Ottawa, Ontario, K1A 0E4, tel.: 613-995-8415, fax 613-995-0480, [www.nrcan.gc.ca/mms/explosif/, Publication]

Ministry of Management Services, Brochures and Publications, Government Publications Centre, 2nd Floor 563 Superior St, Victoria, BC, V8V 4R6, tel.: 1-800-663-6105, fax 250-387-0388 [www.publications.gov.bc.ca]

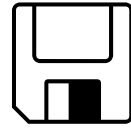

Glossary

Information Resources

Forestry, like any profession, has special terms (and meanings for some common words, such as ‘crown’ and ‘chain’) to describe its practices. Often there are formal definitions and less formal definitions in use, and in some cases, there are many levels of definition to specific terms.

The glossary that follows has tried to define as simply as possible the forestry terms used in this handbook. The definitions are more explanatory than definitive, and are not always comprehensive. More formal definitions can be found in several of the manuals (Silviculture, Policy, Inventory, Protection) produced by the Ministry of Forests.

Additional recommended reference glossaries include:

A Guide To Canadian Forest Inventory Terminology and Usage. 1978. G.M. Bonnor, Canadian Forestry Service

The Woodland Workbook-- Glossary of Woodland Words. 1983. Extension Circular 1155, Oregon State University Extension Service

Terminology of Forest Science, Technology, Practice & Product. 1971. Society of American Foresters, Washington, D.C.

advanced regeneration: Trees that have become established naturally under a mature forest canopy and are capable of becoming the next crop after the mature crop is removed.

adverse slope: An uphill incline for hauling or skidding of logs or other loads.

aerial photography: Photos taken from the air at regular intervals that are used in photo interpretation to provide much information about forests and landforms.

age class: Any interval into which the age range of trees, forests, stands or forest types is divided for classification and use. Forest inventories commonly group trees into 20-year age class groups.

agroforestry: A land management approach that deliberately combines the production of trees with other crops and/or livestock. By blending agriculture and forestry with conservation practices. Agroforestry optimizes economic, environmental and social benefits.

allowable annual cut (AAC): The average volume of wood which may be harvested annually under sustained yield management. Roughly equal to the amount of new growth produced by the forest each year including a proportion of the mature volume less deductions for losses due to fire, insects and disease.

amortization: A procedure by which the capital cost of projects, such as roads or bridges, is written off over a longer period as the timber volumes developed by the projects are harvested and extracted.

artificial regeneration: Establishing a new forest by planting seedlings or by direct seeding (as compared to natural regeneration).

azimuth: The horizontal angle or bearing of a point, measured from the true (astronomic) north. Used to refer to a compass on which the movable dial (which is used to read direction) is numbered in 360°. See also bearing.

backlog: A MOF term applied to forest land areas where silviculture treatments (such as planting/site preparation) are overdue. Planting is considered backlog if more than 5 years have elapsed since a site was cleared (by harvesting or fire) in the Interior and more than 3 years on the coast.

bareroot seedling: Stock whose roots are exposed at the time of planting (as compared to container or plug seedlings). Seedlings are grown in nursery seedbeds and lifted from the soil in which they were grown to be planted in the field.

basic silviculture: A term used by the MOF to refer to the silviculture treatments that are carried out to ensure the establishment of a free growing tree crop. May include: surveying, site preparation, planting, direct seeding or brushing. Compare with intensive silviculture.

bearing: A direction on the ground or on a map, defined by the angle measured from some reference direction: this may be true (geographic) North, magnetic North, or grid North. Used also to refer to a compass on which the movable dial (used to read direction) is numbered as four 90° quadrants where N=0, S=0, E=90, W=90. See also azimuth.

Biltmore stick: A stick graduated in such a way that the diameter of a standing tree may be estimated when the stick is held across the main axis of the tree, and at a distance from the eye for which the stick is graduated (usually 60 cm).

biodiversity: Biological diversity is considered at three levels: ecosystem diversity, species diversity and genetic diversity.

biogeoclimatic classification: The delineation of biotic regions or zones on the basis of vegetation, soils, topography and climate.

biological maturity: In stand management, the age at which trees or stands have peaked in growth rate and are determined to be merchantable. See also rotation age.

blowdown: See windthrown.

- broadcast burning:** A controlled burn, where the fire is intentionally ignited and allowed to proceed over a designated area within well-defined boundaries, for the reduction of fuel hazard or for site preparation. See also slash burning.
- browse:** Small bushes, shrubs, trees and herbs that provide food for wildlife.
- brushing:** A silviculture treatment to remove brush and weed species which compete with seedlings for sunlight, water and soil nutrients. See also conifer release.
- brush rake:** A tool used in mechanical site preparation to penetrate and mix soil and tear roots.
- bucking:** Cutting a felled tree into specified log lengths.
- bud burst:** The time at which the buds on trees and other woody plants begin to grow each year. Also known as bud break or flushing.
- buffer strip:** A strip of land (often including undisturbed vegetation) where disturbance is not allowed or is closely monitored to preserve or enhance aesthetic and other values along or adjacent to roads, trails, watercourses and recreation sites. See also green belt.
- Business Plan:** A plan identifying markets, customers, expenditures and finances required to carry out the identified business, based on projected revenues and costs over a specific period of time.
- cambium:** A single layer of cells between the woody part of the tree and the bark. Division of these cells results in diameter growth of the tree through formation of wood cells (xylem) and inner bark (phloem).
- canopy:** The forest cover of branches and foliage formed by tree crowns.
- chain:** A measuring tape, often nylon, 50 or 75 m in length, used to measure distances.
- certification:** Forest certification is a process where the management of forest land is reviewed by a recognized standards agency to allow the producer to label the wood as produced from an ecologically sustainable operation.
- choker:** A noose of wire rope used for skidding or yarding logs.
- clearcutting:** The harvesting of all trees from an area of forest land in a single cut.
- climax forest:** A forest community that represents the final stage of natural forest succession for its locality (i.e., for its environment). Often identified as those forests that can reproduce indefinitely (i.e., in their own shade).
- clinometer:** A simple instrument for measuring vertical angles or slopes. In forestry, used to measure distance and tree heights.
- close utilization:** Maximum stump height of 30 cm; minimum top dia of 10 cm. See also utilization standards.
- closed canopy:** The description given to a stand when the crowns of the main level of trees forming the canopy are touching and intermingled, and form a barrier to light penetrating the forest floor from above.
- codominant:** In stands with a closed canopy, those trees whose crowns form the general level of the canopy and receive full light from above, but comparatively little from the sides. In young stands, those trees with above average height growth.
- commercial thinning:** A silviculture treatment that 'thins' out an overstocked stand by removing trees that are large enough to be sold as products such as poles or fence posts. It is carried out to improve the health and growth rate of the remaining crop trees. As compared to juvenile spacing.
- coniferous:** Cone-bearing trees having needle or scale-like leaves, usually evergreen and producing wood known commercially as softwoods.

- conifer release:** To release established coniferous trees from a situation in which they have been suppressed, by thinning out undesirable trees and shrubs which have overtopped them. Carried out to improve the growth of the coniferous trees released. See also brushing.
- conk:** A hard, spore-bearing structure of a wood-destroying fungus, which projects beyond the bark of a tree. See also fruiting body.
- contour maps:** A topographic map which portrays relief by means of contour lines.
- control points:** A system of points with established positions or elevations, or both, which are used as fixed references in positioning map features.
- cord:** A pile of stacked rough wood, usually 4 ft by 4 ft by 8 ft (1.2 m × 1.2 m × 2.4 m), containing 128 cubic ft. of wood, bark and air, or approximately 85 cubic ft. of solid wood.
- crop tree:** A tree in a young stand, selected to be retained until final harvest.
- crown:** The live branches and foliage of a tree.
- Crown land:** Land that is owned by the Crown, or province. Referred to as federal Crown land when it is owned by Canada (e.g., Indian Reserves, Dept. of National Defense Lands).
- cruising:** The measurement of standing trees on an area to determine the volume and form of wood on that area. Commonly includes the measurement of other resources on the area, such as soil, wildlife and fisheries.
- culvert:** A drain or covered channel that crosses under a road to lead the water from the upper to the lower side.
- cut bank:** The excavated bank from a ditch line to the top of the undisturbed slope of a road.
- cutblock:** A specific area with defined boundaries authorized for harvest.
- cut period:** The interval between major harvesting operations in the same stand.
- cutting permit:** The document that contains the authority to harvest trees on a Woodlot Licence.
- dbh (diameter breast height):** The stem diameter of a tree measured at breast height (1.3 metres above the point of germination. On flat terrain, this would be ground level; on sloping terrain, this would be the mid-point of the slope between the upper and lower sides of the tree).
- deciduous:** Term applied to trees (commonly broadleaf) that usually shed their leaves annually. Also known commercially as hardwoods.
- declination (magnetic):** The angle between true (geographic) North and magnetic North (direction of the compass needle). The magnetic declination varies for different places and is set on a compass for a particular location to enable magnetic North to be used as a reference point for true North.
- defoliator:** An insect that damages trees by eating leaves or needles.
- depletion:** An income tax allowance reflecting the purchase price paid for merchantable timber, usually on fee simple land. Also, a term used to refer to the process of harvesting your growing stock.
- depreciation:** Reduction in the value of assets, such as equipment and buildings, resulting from their use. Annual income tax allowance for asset depreciation varies with the nature of the asset.
- development objectives:** The short-term (often 5 year) planning objectives for a specific Management Area.
- Development Plan:** A specific plan outlining harvesting, road construction, protection and silviculture activities over the short term (often 5 years) in accordance with the approved Forest Management Plan.

- diameter tape:** A graduated tape based on the relationship of circumference to diameter, which provides a direct measure of tree diameter when stretched around the outside of the tree, usually at breast height. See also dbh.
- dib (diameter inside bark):** The diameter of a tree or log excluding bark thickness.
- disc trencher:** A machine designed for mechanical site preparation. It provides continuous rows of planting spots rather than intermittent patches of the patch scarifiers. Consists of scarifying steel discs equipped with teeth.
- dominant:** Trees with crowns extending above the general level of the canopy and receiving full light from above and partly from the side; taller than the average trees in the stand with crowns well developed.
- dot grid:** A transparent sheet of film (overlay) with systematically arranged dots, each dot representing a number of area units. Used to determine areas on maps, aerial photos and plans, for example.
- drag scarification:** A method of site preparation that disturbs the forest floor and prepares logged areas for regeneration. Often carried out by dragging chains or drums behind a skidder or tractor.
- earlywood:** See springwood.
- ecosystem:** The sum of plants, animals and environmental influences, and their interaction within a particular habitat.
- Environmental Sensitive Areas (ESA):** ESAs for forestry include potentially fragile or unstable soils that may deteriorate unacceptably after forest harvesting, and areas of high value to non-timber resources such as fisheries, wildlife, water and recreation.
- even-aged:** A forest stand or forest type in which relatively small (10–20 year) age differences exist between individual trees. Even-aged stands are often the result of a single regeneration event, such as clearcutting or a seed cutting in the shelterwood method.
- extension services:** Assistance provided to woodland operators. May include help with the preparation of forest management plans, cutting permits, marking trees for selective cutting and guidance in carrying out slash disposal, site preparation and planting.
- favorable slope (or grade):** A downhill (i.e., gravity-assisted) incline for hauling or skidding of logs or other loads.
- feller-buncher:** A harvesting machine that cuts a tree by shears or a saw and then piles it.
- felling:** The act of cutting down a standing tree.
- fertilization:** The addition of fertilizer to promote tree growth on sites deficient in one or more soil nutrient elements. Also used to improve the vigor of crop trees following juvenile spacing or commercial thinning.
- fill bank:** The fill material used to shape a road from the outer edge of the traveled portion to its intersection with the existing ground profile.
- fill-in planting:** Planting required to supplement poorly stocked natural regeneration or to replace seedlings that have died on previously planted sites.
- financial maturity:** The age at which a stand of timber offers the maximum return on investment in terms of volume and grade yield.
- firebreak:** Areas or strips of less flammable fuels that are either natural (such as standing timber or landslides) or are made in advance (such as cat trails or roads), as precautionary measures, separating areas of greater fire hazard.
- fire guard:** A man-made barrier (often an area cleared of fuels) constructed at the time of a fire to control it and provide a point from which to carry out fire suppression.

Fisheries Sensitive Zones: Aquatic environments important for the life history of fish, including areas which may not be defined as streams. May include side and flood channels, swamps, seasonally flooded depressions, lake spawning areas or estuaries.

fixed area plot sampling method: A controlled cruise method whereby small plots of a fixed size are used to sample a portion of a forest area to obtain information (such as tree volume) that can be used to describe the whole area.

flagging tape: Coloured plastic tape which comes in rolls and is used to mark (flag) boundaries or identify certain trees or objects.

flushing: See bud burst.

forage: Grasses, small shrubs and other plant material that can be used as feed for livestock.

forest: A plant community predominantly of trees and other woody vegetation, growing more or less closely together.

forest cover map: A map showing relatively homogeneous forest stands or cover types, produced from the interpretation of aerial photos and information collected in field surveys. Commonly includes information on species, age class, height class, site and stocking level.

forest ecology: The relationships between forest organisms and their environment.

forest inventory: A survey of a forest area to determine such data as area condition, timber volume and species, for specific purposes such as planning, purchases, evaluation, management or harvesting.

forest land (BC Assessment Authority): Land having as its highest and best use the growing and harvesting of trees.

forest management cycle: The phases that occur in the management of a forest, including harvesting, site preparation, reforestation, and stand tending.

Forest Management Plan: A general plan for the management of a forest area, usually for a full rotation cycle. including the objectives, prescribed management activities and standards to be employed to achieve specified goals. Commonly supported with more detailed Development Plans.

forest renewal: The renewal of a tree crop, whether by natural or artificial means.

forest type: A group of forested areas or stands of similar composition (species, age, height and stocking) which differentiates it from other such groups.

forest type labels: The symbols which are used to code information about forest types on a forest cover map (e.g., site, disturbance, age and height class, species, stocking).

forest type lines: Lines on a map or aerial photo outlining forest types.

free growing: Young trees that are as high as or higher than competing brush vegetation, with one metre of free growing space surrounding their leaders.

fruiting body: The reproductive part of a fungus that contains or bears spores. Also known as a conk.

fuelbreak: See firebreak.

fuel management: The activities carried out to modify fuel accumulations (slash) to reduce the chance of ignition and rate of fire spread.

fuelwood: Trees used for the production of firewood logs or other wood fuel.

fungus: A plant that obtains its nourishment through the organic matter of other plants, causing decay.

galleries: Passages carved out under bark on in wood by insects feeding or laying eggs.

Geographic information system (GIS): A computerbased mapping system that combines digital maps and databases.

girdling: To kill a tree by severing or damaging the cambium layer and interrupting the flow of food between the leaves and the rest of the tree. A method of brushing, carried out using a hatchet or special tool to cut through the bark and cambium of the tree.

grading: Classifying timber, lumber or logs according to quality or end-use.

grapple yarder: A machine used in harvesting to bring logs into a landing. The grapple closes like teeth around the log and is controlled by the machine operator.

green belt: A strip of undisturbed soil and vegetation left along waterways or access routes to minimize the environmental impact from development. See also buffer strip.

gross sales: Where the buyer purchases on an area basis, all timber for a fixed price.

gross total volume: Volume of the main stem of the tree, including stump and top. Volume of the stand, including all trees.

habitat: The place where an organism lives and/or the conditions of that environment including the soil, vegetation, water and food.

habitat management: Management of the forest to create environments which provide habitats (food, shelter) to meet the needs of particular species of wildlife, birds, etc.

hack and squirt: A method of conifer release and juvenile spacing where the bark of a tree is cut (hack) and herbicides are injected (squirt) to kill the tree.

harvest cut: The felling of the mature crop of trees, either as a single clearcutting or a series of regeneration cuttings.

harvesting: The cutting and removal of trees from a forested area.

hauling: A general term for the transport of logs from one point to another, usually from a landing to the mill or shipping point.

heartwood: The inner core of a woody stem, composed of nonliving cells and usually differentiated from the outer wood layer (sapwood) by its darker colour.

height class: Any interval into which the range of tree heights is divided for classification and use; commonly 3, 5 or 10 metre classes.

height/diameter curve: A graphic representation of the relationship between individual tree heights and diameters that is used to determine tree volumes for localized areas.

herbicides: Chemicals used to kill vegetation such as brush, weeds and competing or undesirable trees.

high-grading: The removal from the stand of only the best trees, often resulting in a poor-quality residual stand.

highlead system: Logging system that uses cables rigged to a spar high above the ground so that one end of the logs can be lifted during yarding.

hinge wood: A term used in felling to indicate the portion of the tree that remains uncut, between the backcut and the undercut. Its width and location are used to influence the direction in which the tree falls.

hip chain: A device used to measure distance by running an anchored filament around a wheel which revolves as you walk (handy for measuring distances on your own).

humus: A general term for the more or less decomposed (plant and animal) residues in the upper soil layer.

hypometer: A simple instrument (often a stick or other straight edge) used to measure the heights of trees on the basis of similar angles.

- improvement cutting:** The removal of trees of undesirable species, form or condition from the main canopy of the stand to improve the health, composition and value of the stand.
- increment borer:** A tool used to extract a core of wood from a living tree, for the purpose of studying the annual growth rings of the tree.
- incremental silviculture:** See intensive silviculture.
- increment core:** That part of the cross section of a tree extracted by an increment borer. Used to determine tree age and growth pattern.
- insecticides:** Chemicals used to kill insects.
- integrated forest companies:** Forest companies that both produce logs and manufacture them into lumber, pulp and other wood products.
- integrated resource management:** The management of two or more resources in the same general area; commonly includes water, soil, timber, range, fish, wildlife and recreation.
- intensive silviculture:** A MOF term that refers to the treatments carried out to maintain or increase the yield and value of forest stands. Includes treatments such as site rehabilitation, conifer release, spacing, pruning and fertilization. Also known as incremental silviculture. Compare with basic silviculture.
- intermediate trees:** Trees shorter than the dominant and codominant trees in a stand, and with crowns below the general canopy formed by these trees. See also dominant, codominant, canopy.
- intertree distance:** The distance between tree crowns, usually used in the context of thinning. Recommended guidelines for intertree distances are established for different thinning programs depending on the species and age of trees, site variables and management objectives.
- juvenile spacing:** A silvicultural treatment to reduce the number of trees in young stands, often carried out before the stems removed are large enough to be used or sold as a forest product. Prevents stagnation and improves growing conditions for the remaining crop trees so that at final harvest the end-product quality and value is increased. See also commercial thinning.
- kickback:** The sudden and dangerous jump of the butt of a falling tree as it comes down. Also, the abrupt and dangerous backward movement of a chainsaw toward the operator, often caused by touching the moving chain at the tip of the bar to an object when starting to cut.
- landing:** The area where logs are collected for loading.
- latewood:** See summerwood.
- leave trees:** Trees selected to be left on an area following harvesting or thinning operations for the purpose of continued growth and/or seed dissemination. See also residual trees.
- litter layer:** The layer of organic debris, mainly bark, twigs and leaves, on the forest floor.
- logging plan:** A schedule of operations for a specific area that describes in words and on a map how and where harvesting will take place.
- loss factors:** Reductions made to gross volumes to allow for decay, waste and breakage.
- MAI (mean annual increment):** The average annual increase in volume of individual trees or stands up to the specified point in time. The MAI changes with different growth phases in a tree's life; being highest in the middle years and then slowly decreasing with age. The point at which the MAI peaks is commonly used to identify the biological maturity of the tree, and its readiness for harvesting.
- managed forest land:** Forest land that is being managed under a forest management plan.

Management Area: Stands or forest types that require similar management practices and can be grouped for treatment as a management unit.

management objectives: The long-term management strategies for a forest area.

map folio: A collection of a series of maps bound together; often produced as overlays of information (e.g., soils, fish, water, forest and wildlife).

merchantable timber: A tree or stand that has attained sufficient size, quality and/or volume to make it suitable for harvesting.

merchantable volume: The amount of sound wood in a single tree or forest stand that is suitable for marketing under given economic conditions.

meridian lines: A north-south reference line often appearing on maps. Meridian lines are also etched into the bearing plate on a compass.

microclimate: Generally, the climate of small areas, especially insofar as this differs significantly from the general climate of the region. Stands often create microclimates.

microsite: A small area which exhibits localized characteristics different from the surrounding area. For example, the microsites created by a rock outcrop with thin soils, or the shaded and cooled areas created on a site by the presence of slash.

mill rate: Property assessment based on a set rate per \$1,000 of land value.

natural regeneration: The renewal of a tree crop by natural (as compared to human) means (e.g., seed on-site, from adjacent stands, or brought in by wind, birds or animals).

net present value (NPV): A stand's present worth (before harvesting) once costs associated with its establishment and tending have been subtracted.

net volume: Volume of the main stem, excluding stump and top as well as defective and decayed wood, of trees or stands.

non-forest land: Land not primarily intended for growing, or not supporting forest.

non-timber resources: Commodities other than timber, such as floral greens, mushrooms, native plants, medicinal herbs, berries and crafts.

NSR (not satisfactorily restocked): Productive forest land that has been denuded and has failed partially or completely to regenerate naturally or to be artificially regenerated.

old growth: A forest of mature or overmature timber that is beyond its peak growing period.

operational cruise: An estimate, to a specified degree of accuracy, of the volume of timber on an area to be harvested.

overstorey: That portion of the trees, in a forest of more than one storey, forming the upper or uppermost canopy layer.

overtopping: Vegetation higher than the favoured species, as in brush or deciduous species that are shading and suppressing more desirable coniferous trees.

per hectare factor: A number used to convert sample plot information to per hectare information (as in converting the plot volume to a per hectare volume).

periodic harvests (periodic cut): The removal of several years' accumulated AAC in one year or other period.

pest: An organism capable of causing material damage. Forest pests include insects and diseases.

pesticides: A general term for chemicals used to kill either vegetation (herbicides) or insect pests (insecticides).

phloem: A layer of tree tissue, just inside the bark, that conducts food from the leaves to the stem and roots.

pioneer plants: A succession term for plants capable of invading bare sites (e.g., a newly exposed soil surface) and persisting there and colonizing them until supplanted by invader or other succession species.

pitch tubes: A tubular mass of resin that forms on the surface of bark at bark-beetle entrance holes.

pith: The central core of a stem and of some roots, representing the first year of growth and consisting mainly of soft tissue.

plot: A carefully measured area laid out for experimentation or measurement.

plug: A seedling grown in a small container, under carefully controlled (nursery) conditions. When seedlings are removed from containers for planting, the nursery soil remains bound up in their roots.

point of sale: The specific area where a product (i.e., tree, log) becomes the property of the buyer.

pre-harvest silviculture assessment (or survey): The survey carried out on a stand prior to logging to collect specific information on the silvicultural conditions such as planting survival, free growing status, stocking. See also silvicultural survey.

pre-harvest silviculture prescription: A planning system involving the collection of site-specific field data and the development of forest management prescriptions for cutblocks in advance of logging.

prescribed burning: The knowledgeable application of fire to a specified land area to accomplish designated land management objectives.

professional agrologist: A person registered under the *Agrologists Act*, who performs or directs works, services or undertakings requiring specialized knowledge, training and experience in the science of agriculture and associated natural resources (P.Ag.).

provincial forest inventory: A description of the quantity and quality of forest trees, non-wood values, and many of the characteristics of the land base, compiled from statistical data for the forest lands of the province.

pruning: The manual removal of the lower branches of crop trees, to a predetermined height to produce clear, knot-free wood.

railway grade: the roadbed upon which ties and rails were laid.

range: The general term for all rangelands in which edible forage is located within grasslands, open forests and forest ranges.

reamer: A steel tool with a tapered shank used for freeing stuck increment cores from an increment borer.

reforestation: The natural or artificial restocking (i.e., planting, seeding) of an area with forest trees. Also called forest regeneration.

regeneration delay: The maximum time allowed for initial restocking of a denuded area (e.g., from harvesting, fire) with the minimum number of acceptable trees. The delay is measured in growing seasons from time of denudation.

regeneration performance assessment (RPA): A sampling survey carried out to collect field data on the height growth, competition, and stocking of young stands (5–10 years).

regeneration survey: Carried out to determine the initial restocking of a site. It is used to describe the number of trees on a site that have reached acceptable standards.

registered professional forester: A person registered under the *Foresters Act*, who performs or directs works, services or undertakings requiring specialized knowledge, training and experience in forestry.

residual trees: Trees remaining in an area following harvesting. Usually non-commercial trees by virtue of species, size or quality. See also leave trees.

right-of-way: The strip of land over which a power line, railway line or road extends.

roundwood: Sections of tree stems, with or without bark. Includes logs, bolts, posts and pilings.

rotation age: The age at which a stand is considered mature and ready for harvesting. See also biological maturity.

salvage: To harvest trees that are dead or in poor condition, but that still yield a wood product. Often carried out following fire or insect attack.

sanitation cutting: The removal of damaged or diseased stems to prevent the spread of insects or disease.

sapwood: The light-coloured wood that appears on the outer portion of a cross section of a tree.

scaling: The measuring of lengths and diameters of logs and calculating deductions for defect to determine volume.

scarification: A method of seedbed preparation which consists of exposing patches of mineral soil by mechanical action.

screefing: Removing weeds and small plants together with most of their roots, to clear the area immediately surrounding a planting hole.

second growth: A second forest that develops after harvest of the original mature old growth forest.

seedbed: In natural regeneration, the soil or forest floor on which seed falls; in nursery practice, a prepared area over which seeds are sown.

seed orchard: An area of specially planted trees that have been selected for their superior characteristics (i.e., growth, volume, branching, pest resistance) to breed genetically improved seeds.

selection cutting: An uneven-aged silviculture system in which trees are harvested individually or in small groups continuously, at relatively short intervals.

seral stage: The series of changes occurring in the ecological succession of a plant community. (e.g., pioneer stage, or climax stage).

SFM: See sustainable forest management.

shade-tolerant: The capacity of a tree or plant species to develop and grow in the shade of (and in competition with) other trees or plants.

shearing: In Christmas tree culture, to prune the branches to make dense foliage and give the tree a conical shape.

shelterwood: Any harvest cutting of a more or less regular and mature crop, designed to establish a new crop under the protection of the old.

silviculture: The art and science of growing and tending a forest.

silviculture survey: A sampling procedure to determine silvicultural conditions such as planting survival, free growing status or stocking, and leading to management decisions. See also pre-harvest silviculture assessment.

silviculture system: A process, following accepted silvicultural conditions, whereby forests are tended, harvested and replaced (e.g., clearcutting, seed tree, selection cutting, shelterwood cutting).

site class: The measure of the relative productive capacity of a site for a particular crop or stand, based on volume or height at a given age. Forest sites are broadly classed as good, medium, poor or low

- site index:** indicates the ability of a site to produce commercial timber crops based on the estimated average height of the dominant trees of the leading species at age 50, and measured at breast height.
- site preparation:** Disturbance of an area's topsoil and ground vegetation to create conditions suitable for regeneration.
- site rehabilitation:** The conversion of the existing unsatisfactory cover on highly productive forest sites to a cover of commercially valuable species.
- skidder:** A wheeled or tracked vehicle used for sliding/dragging logs from the stump to a landing.
- skidding:** The process of sliding/dragging logs from the stump to a landing, usually applied to ground-based operations.
- skid trail:** A rough-formed, temporary forest trail suitable for use by horses or equipment such as bulldozers or skidders in bringing trees or logs from the actual place of felling to a landing.
- skyline:** A type of cable logging in which the mainline is stationary and a carriage moves along it carrying logs from the felling site to the landing.
- slash:** The residue left on the ground after felling, includes unused logs, uprooted stumps and broken tops, for example.
- slash burning:** The burning of logging slash, often carried out to reduce fire hazard and/or to prepare a site for planting. See also broadcast burning.
- slope correction tables:** Tables with conversions from slope distance to horizontal distance.
- small-scale forestry:** In general, non-industrial forestry operations. In BC, small-scale forestry operations are carried out by Woodlot Licensees, First Nations and private land-owners.
- soil compaction:** The compression of soil as a result of heavy equipment traffic.
- spacing:** The act of removing trees from a stand to decrease the stand density, distribute the crop trees more evenly over the growing site, and create more growing room. See also intertree distance, juvenile spacing and thinning.
- special forest products:** As defined under the *Forest Act* to include poles; posts; pilings; Christmas trees; building logs; mining timbers; cribbing; firewood and fuel logs; hop poles; orchard props; car stakes; round stakes, sticks and pickets; split stakes, pickets and palings; shake bolts, blocks and blanks; shingle blocks.
- springwood:** The less dense, larger wood cells of an annual growth ring. Also called earlywood to refer to the fact that it is the wood formed early in the growing season. See also summerwood.
- spur road:** A branch of a main or secondary road.
- stand:** A community of trees sufficiently uniform in species, age, arrangement or condition to be distinguishable as a group from the forest or other growth on the area.
- stand density:** A relative measure of the amount of stocking on a forest area. Often described in terms of stems per hectare.
- stand improvement:** Any silvicultural treatment that increases the growth, quality or value of trees in a stand.
- stand tending:** A variety of forest management activities carried out at different stages in the life of a stand. Treatments may include: juvenile spacing, brushing, commercial thinning, fertilization, conifer release, site rehabilitation, mistletoe control, seed tree control, and pruning.
- statistical sampling:** The selection of sample units from a population and the measurement and/or recording of information on these units, to obtain estimates of population characteristics.

- stocking class:** A numeric code representing a range of stems per hectare, sometimes estimated by crown closure on aerial photographs (e.g., stocking class 1 is mature with 76+ stems/ha of > 27.5 cm dbh; class 2 is mature with < 76 stems/ha; class 0 is immature).
- stomata:** Pores in plant leaves that control the respiration of a plant.
- strata:** Groups of forest types with the same or similar species composition, age and height classes (plural of stratum).
- stratum:** A subdivision of a forest area to be inventoried, based on a group of trees with the same or similar species composition, age and height class.
- stream gradient:** The general slope, or rate of vertical drop per unit of length, of a flowing stream.
- stumpage:** The price that must be paid to the provincial government for timber harvested from Crown land.
- stumpage appraisal:** The process by which the stumpage to be charged for harvesting on any given area is estimated.
- sub-grade:** That part of a road consisting of the material already in place (the road base).
- succession:** The replacement of one plant community by another in progressive development toward climax vegetation.
- summerwood:** The denser, later-formed wood of an annual growth ring. Also known as 'latewood' relating to the time in the growing season that these cells are produced. See also springwood.
- suppressed:** Trees with crowns entirely below the general level of the crown cover receiving little or no direct light from above or from the sides.
- survival assessment:** A survey that estimates survival, which is the percentage of trees living after a period of growth (often 2–5 years) following planting.
- sustainable forest management (SFM):** Broader forest management concept than sustained yield. SFM strives to manage and sustain the full range of social economic and environmental values inherent in a forest.
- sustained yield:** A method of forest management that calls for an approximate balance between net growth and amount harvested.
- tenure:** The holding, particularly as to manner or term (i.e., period of time), of a property. Land tenure may be broadly categorized into private lands, federal lands and provincial Crown lands. The Forest Act defines a number of forestry tenures by which the cutting of timber and other user rights to Crown land are assigned.
- thinning:** The process of removing excess and poorer quality trees from a stand for the purpose of improving the growth and value of the remaining crop trees.
- timber cruising:** The collection of field data on forests, commonly by the measurement and recording of information in sample plots. Includes the measurement and estimation of volumes of standing trees.
- timber mark:** A hammer indentation made on cut timber for identification purposes.
- tolerance:** A relative measure of a tree's ability to survive a deficiency of light, water or nutrients (i.e., shade-tolerant trees can grow under the shade of other plants, in conditions of low light).
- Tree Farm Licence:** A form of tenure agreement which allows the long-term practice of sound forest management and harvesting on Crown land or a combination of Crown and private land, by private interests under the supervision of the Forest Service.

tree-shearer: A mechanical device used in felling that cuts or shears the standing tree off at the stump.

trim allowance: The extra length (usually 20 cm) of a bucked log to allow for trimming waste in the sawmill.

turnout: A space adjacent to a road in which vehicles may park or pull into to allow others to pass.

understory: That portion of the trees or other vegetation in a forest stand below the main canopy level.

uneven-aged: Stands with a wide range of ages and sizes.

unit sales: Sale of timber based on an agreed 'price per unit of material for timber volume' with payment based on scaled volume.

unmanaged forest land: Forest land that is not subject to management under a forest management plan.

utilization standards: The utilization limits (stump height and top diameter inside bark) which define the trees considered to be commercially scaleable, and therefore the dimensions of all trees that must be cut and removed from Crown land harvesting operations. See close utilization.

variable area plot sampling method: A method of timber cruising commonly used for industrial timber cruising in which sampling area (plot size) varies with tree diameter.

Volume Table: A table showing the estimated average tree or stand volume based on given tree measurements (usually diameter and height).

V-plow: A forest plow with a V-shaped blade used to prepare strips for hand planting by removing surface debris and competing vegetation.

water bar: A shallow trench cut into the surface of road, or created by an embankment (e.g., log and soil), to collect and channel water off the surface, to avoid erosion.

watershed: An area of land that collects and discharges water into a main stream through a series of smaller tributaries.

weir: An enclosure set in a waterway for catching fish.

windfirm: Trees that can withstand normal and intermittent heavy winds.

wildling: A seedling naturally reproduced outside of a nursery, used in forest planting.

windrowing: The concentration of slash, branchwood and debris into rows to clear the ground for regeneration. Windrows are often burned.

windthrown: Trees that have been blown over by wind. Also known as blowdown.

witches' broom: An abnormal tufted growth of small branches on a tree or shrub caused by fungi or viruses.

wolf tree: A vigorous tree that has merchantable value but occupies more space than its value warrants. Usually broad crowned, dominant and very limby. Often a remnant from a previous stand.

Woodlot Licence: An area based forest tenure containing not more than 400 ha on the Coast and 600 ha in the interior of Crown land which may be managed in conjunction with some private land.

xylem: The principal strengthening and water-conducting tissue of stems, leaves and roots.

yarding: Moving trees or logs from felling site to roadside with cable, winch or helicopter.

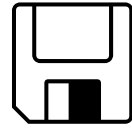

Contact Addresses

Information Resources

In this chapter...

Ministry of Forests	289
Canadian Forest Service	298
Woodlot Associations	299
Federation of BC Woodlot Associations	301
Education Institutions	301
Other Agencies and Institutions	302
Other Ministries	303
Forest Seedling Nurseries	304

.....

EXTENSION SERVICES
BC Ministry of Forests
14275 - 96th Ave. Surrey, BC V3V 7Z2

Carol Robertson	Reception	Tel:	604-930-3300
		Em:	Carol.Robertson@gems4.gov.bc.ca
		Fax:	604-775-1288
Don Summers	Manager	Tel:	604-930-3301
		Em:	Don.Summers@gems1.gov.bc.ca
Diane Gertzen	Christmas Tree Specialist	Tel:	604-930-3309
		Em:	Diane.Gertzen@gems3.gov.bc.ca
Dave Trotter	Pest Management Specialist	Tel:	604-930-3302
		Em:	Dave.Trotter@gems4.gov.bc.ca
Eric van Steenis	Forest Nursery Specialist	Tel:	604-930-3303
		Em:	Eric.vanSteenis@gems5.gov.bc.ca
Cheryl Calam	Test Nursery Supervisor	Tel:	604-930-3311
		Em:	Cheryl.Calam@gems8.gov.bc.ca
Artur Moeller	Operational Trials Technician	Tel:	604-930-3305
		Em:	Art.Moeller@gems5.gov.bc.ca

TREE SEED CENTRE
BC Ministry of Forests
18793 - 32nd Ave., Surrey, BC V4P 1M5

Kaela Simon	Reception	Tel:	604-541-1683
		Fax:	604-541-1685
Rob Bowden-Green	Manager	ext	223
Heather Rooke	Operations Supervisor	ext	224
Dawn Stublely	Production and Distribution Supervisor	ext	239
Dave Kolotelo	Seed Improvement Specialist	ext	228

BC MINISTRY OF FORESTS LIBRARY
4th Floor, 722 Johnson Street
PO Box 9523 STN PROV GOVT
Victoria, BC V8W 3E7

<http://www.for.gov.bc.ca/HFD/library/>

Roxanne Smith	Tel:	250-387-3628	Em:	Roxanne.Smith@gems7.gov.bc.ca
	Fax:	250-953-3079		

TREE IMPROVEMENT BRANCH
BC Ministry of Forests
3 - 712 Yates
Victoria, BC V8W 9C2

Tel: 250-387-8939
Fax: 250-356-8124
www.for.gov.bc.ca/TIP/index.html

Dale Draper	Director	Tel:	250-387-3179
Roger Painter	Tree Improvement Coordinator	Tel:	250-356-9276
Ron Planden	Seed Planning Forester	Tel:	250-652-8303
Susan Zedel	Technician	Tel:	250-356-1598
Anita Buist	Reception	Tel:	250-387-8939

Ministry of Forests Contact Addresses (May 2002)

Town/City	Office	Address
REGION		
Williams Lake	Cariboo Forest Region Ph: (250) 398-4345 Fax: (250) 398-4380 Forests.CaribooRegionOffice@gems3.gov.bc.ca	200 640 Borland Street, Williams Lake, BC V2G 4T1
Kamloops	Kamloops Forest Region Ph: (250) 828-4131 Fax: (250) 828-4154 Forests.KamloopsRegionOffice@gems3.gov.bc.ca	515 Columbia Street, Kamloops, BC V2C 2T7
Prince George	Prince George Forest Region Ph: (250) 565-6100 Fax: (250) 565-6671 Forests.PrinceGeorgeRegionOffice@gems3.gov.bc.ca	1011 - 4th Avenue, Prince George, BC V2L 3H9
Smithers	Prince Rupert Region Ph: (250) 847-7500 Fax: (250) 847-7217 Forests.PrinceRupertRegionOffice@gems3.gov.bc.ca	Bag 5000, 3726 Alfred Avenue, Smithers, BC V0J 2N0
Nanaimo	Vancouver Forest Region Ph: (250) 751-7001 Fax: (250) 751-7190 Forests.VancouverRegionOffice@gems3.gov.bc.ca	2100 Labieux Road, Nanaimo, BC V9T 6E9
DISTRICT		
100 Mile House	100 Mile House Forest District Ph: (250) 395-7800 Fax: (250) 395-7810 Forests.100MileHouseDistrictOffice@gems3.gov.bc.ca	PO Box 129, 300 South Cariboo Highway 97, 100 Mile House, BC V0K 2E0
Castlegar	Arrow Forest District Ph: (250) 365-8600 Fax: (250) 365-8568 Forests.ArrowDistrictOffice@gems3.gov.bc.ca	845 Columbia Avenue, Castlegar, BC V1N 1H3
Atlin	Atlin Field Office Ph: (250) 651-7638 Fax: (250) 651-7780	Box 45, McBride Blvd., Atlin, BC V0W 1A0 Note: Seasonal
Grand Forks	Boundary Forest District Ph: (250) 442-5411 Fax: (250) 442-5468 Forests.BoundaryDistrictOffice@gems3.gov.bc.ca	PO Box 2650, 136 Sagamore Avenue Grand Forks, BC V0H 1H0

Smithers	Bulkley/Cassiar Forest District Ph: (250) 847-6300 Fax: (250) 847-6353 Forests.BulkleyCassiarDistrictOffice@gems3.gov.bc.ca	Bag Service 6000, 3333 Tatlow Road, Smithers, BC V0J 2N0
Campbell River	Campbell River Forest District Ph: (250) 286-9300 Fax: (250) 286-9490 Forests.CampbellRiverDistrictOffice@gems3.gov.bc.ca	370 South Dogwood Street, Campbell River, BC V9W 6Y7
Alexis Creek	Chilcotin Forest District Ph: (250) 394-4700 Fax: (250) 394-4515 Forests.ChilcotinDistrictOffice@gems3.gov.bc.ca	PO Box 65, Stum Lake Road, Alexis Creek, BC V0L 1A0
Chilliwack	Chilliwack Forest District Ph: (604)-702-5700 Fax: (604)-702-5711 Forests.ChilliwackDistrictOffice@gems3.gov.bc.ca	46360 Airport Road Chilliwack, BC V2P 1A5
Clearwater	Clearwater Forest District Ph: (250) 587-6700 Fax: (250) 587 6790 Forests.ClearwaterDistrictOffice@gems3.gov.bc.ca	loc.: 687 Yellowhead South, Hwy 5 mail: PO Box 4501, R.R.#2, Clearwater, BC V0E 1N0
Clinton	Clinton Field Office Ph: (250) 459-2235 Fax: (250) 459-7082	Box 340, 1423 Cariboo Highway, Clinton, BC V0K 1K0
Cobble Hill	Cobble Hill Field Office (South Island Forest District) Ph: (250) 743-8933 Fax: (250) 743-7299	location: 3819 Trans Canada Hwy, Cobble Hill, BC V0R 1L0 c/o Access Center 5785 Duncan St Duncan, BC V9L 5G2
Revelstoke	Columbia Forest District Ph: (250) 837-7611 Fax: (250) 837-7626 Forests.ColumbiaForestDistrict@gems3.gov.bc.ca	Box 9158, RPO #3, 1761 Big Eddy Road Revelstoke, BC V0E 3K0
Cranbrook	Cranbrook Forest District Ph: (250) 426-1700 Fax: (250) 426-1777 Forests.CranbrookDistrictOffice@gems3.gov.bc.ca	1902 Theatre Road, Cranbrook, BC V1C 6H3
Creston	Creston Field Office Ph: (250) 428-3213 Fax: (250) 428-2773	RR6 1243 Northwest Blvd Creston BC V0B 1G6
Dawson Creek	Dawson Creek Forest District Ph: (250) 784-1200 Fax: (250) 784-2356 Forests.DawsonCreekDistrictOffice@gems3.gov.bc.ca	9000 - 17th Street, Dawson Creek, BC V1G 4A4

Dease Lake	Dease Lake Field Office (Bulkley/Cassiar Forest District) Ph: (250) 771-8100 Fax: (250) 771-5700	Bag 2000 Dease Lake, BC V0C 1L0
Fort Nelson	Fort Nelson Forest District Ph: (250) 774-5511 Fax: (250) 774-3704 Forests.FortNelsonDistrictOffice@gems3.gov.bc.ca	R.R.#1, Mile 301, Alaska Highway, Fort Nelson, BC V0C 1R0
Fort St. James	Fort St. James Forest District Ph: (250) 996-5200 Fax: (250) 996 5290 Forests.FortStJamesDistrictOffice@gems3.gov.bc.ca	PO Box 100, Stones Bay Road, Fort St. James, BC V0J 1P0
Fort St. John	Fort St. John Forest District Ph: (250) 787-5600 Fax: (250) 787-5610 Forests.FortStJohnDistrictOffice@gems3.gov.bc.ca	8808-72nd Street, Fort St. John, BC V1J 6M2
Golden	Golden Sub Office (Columbia Forest District) Ph: (250) 344-7500 Fax: (250) 344-7501	PO Box 1380, 800 - Ninth St. North, Golden, BC V0A 1H0
Horsefly	Horsefly Forest District Ph: (250) 620-3200 Fax: (250) 620-3540 Forests.HorseflyDistrictOffice@gems3.gov.bc.ca	Box 69, Horsefly Lake Road Horsefly, BC V0L 1L0
Invermere	Invermere Forest District Ph: (250) 342-4200 Fax: (250) 342-4247 Forests.InvermereDistrictOffice@gems3.gov.bc.ca	Box 189, 625 - 4th Street Invermere, BC V0A 1K0
Terrace	Kalum Forest District Ph: (250) 638-5100 Fax: (250) 638-5176 Forests.KalumDistrictOffice@gems3.gov.bc.ca	200-5220 Keith Avenue, Terrace, BC V8G 1L1
Kamloops	Kamloops Forest District Ph: (250) 371-6500 Fax: (250) 828-4627 Forests.KamloopsDistrictOffice@gems3.gov.bc.ca	1265 Dalhousie Drive, Kamloops, BC V2C 5Z5
Rock Creek	Kettle Valley Field Office Ph: (250) 446-2212 Fax: (250) 442-0350 (Grand Forks office)	R.R. #2, Highway #3, Rock Creek, BC V0H 1Y0
Hazelton	Kispiox Forest District Ph: (250) 842-7600 Fax: (250) 842-7676 Forests.KispioxDistrictOffice@gems3.gov.bc.ca	Mail: Bag 5000, Smithers BC V0J 2N0 Location: 2210 West Highway 62, Hazelton, BC V0J 1Y0
Nelson	Kootenay Lake Forest District Ph: (250) 825-1100 Fax: (250) 825-9657 Forests.KootenayLakeDistrictOffice@gems3.gov.bc.ca	1907 Ridgewood Road Nelson BC V1L 6K1

Burns Lake	Lakes Forest District Ph: (250) 692-2200 Fax: (250) 692-7461 Forests.LakesDistrictOffice@gems3.gov.bc.ca	Bag 3500, 185 Yellowhead Highway, Burns Lake, BC V0J 1E0
Likely	Likely Field Office Ph: (250) 790-2213 Fax: (250) 790-2325	Box 7, Cedar Creek Road, Likely, BC V0L 1N0
Lillooet	Lillooet Forest District Ph: (250) 256-1200 Fax: (250) 256-1290 Forests.LillooetDistrictOffice@gems3.gov.bc.ca	Bag Service 700, 650 Industrial Place Lillooet, BC V0K 1V0
Mackenzie	Mackenzie Forest District Ph: (250) 997-2200 Fax: (250) 997-2236 Forests.MackenzieDistrictOffice@gems3.gov.bc.ca	Bag 5000 #1 Cicada Road Mackenzie, BC V0J 2C0
Merritt	Merritt Forest District Ph: (250) 378-8400 Fax: (250) 378-8481 Forests.MerrittDistrictOffice@gems3.gov.bc.ca	Bag 4400, Stn Main Highway 5A + Airport Road Merritt, BC V1K 1B8
Hagensborg	Mid Coast Forest District Ph: (250) 982-2000 Fax: (250) 982-2090 Forests.MidCoastDistrictOffice@gems3.gov.bc.ca	Location: Sawmill Road, Hagensborg, BC Mail: PO Box 1000 Bella Coola, BC V0T 1C0
Houston	Morice Forest District Ph: (250) 845-6200 Fax: (250) 845-6276 Forests.MoriceDistrictOffice@gems3.gov.bc.ca	Bag 2000, 2430 Butler Avenue, Houston, BC V0J 1Z0
Nakusp	Nakusp Field Office Ph: (250) 265-3685 Fax: (250) 265-3067	Box 219, 109-6th Avenue West, Nakusp, BC V0G 1R0
Nelson	Nelson Forest Region Ph: (250) 354-6200 Fax: (250) 354-6250 Forests.NelsonRegionOffice@gems3.gov.bc.ca	518 Lake Street, Nelson, BC V1L 4C6
Prince Rupert	North Coast Forest District Ph: (250) 624-7460 Fax: (250) 624-7479 Forests.NorthCoastDistrictOffice@gems3.gov.bc.ca	125 Market Place, Prince Rupert, BC V8J 1B9
Penticton	Penticton Forest District Ph: (250) 490-2200 Fax: (250) 490-2255 Forests.PentictonDistrictOffice@gems3.gov.bc.ca	102 Industrial Place, Penticton, BC V2A 7C8
Port McNeill	Port McNeill Forest District Ph: (250) 956-5000 Fax: (250) 956-5005 Forests.PortMcNeillDistrictOffice@gems3.gov.bc.ca	PO Box 7000, 2217 Mine Rd Port McNeill, BC V0N 2R0

Prince George	Prince George Forest District Ph: (250) 614-7400 Fax: (250) 614-7435 Forests.PrinceGeorgeDistrictOffice@gems3.gov.bc.ca	2000 S. Ospika Blvd., Prince George, BC V2N 4W5
Princeton	Princeton Field Office Ph: (250) 295-3106 or 1-800-665-1511 Fax: (250) 295-6273	Location: 151 Vermillion Avenue, Princeton, BC Mail: PO Box 4400, Stn Main Merritt BC V1K 1B8
Queen Charlotte City	Queen Charlotte Islands Forest District Ph: (250) 559-6200 Fax: 559-8342 Forests.QueenCharlotteDistrictOffice@gems3.gov.bc.ca	PO Box 39, 1229 Cemetary Road, Queen Charlotte City, BC V0T 1S0
Quesnel	Quesnel Forest District Ph: (250) 992-4400 Fax: (250) 992-4403 Forests.QuesnelDistrictOffice@gems3.gov.bc.ca	322 Johnston Avenue, Quesnel, BC V2J 3M5
McBride	Robson Valley Forest District Ph: (250) 569-3700 Fax: (250) 569-3738 Forests.RobsonValleyDistrictOffice@gems3.gov.bc.ca	PO Box 40 380 Highway 16 West McBride, BC V0J 2E0
Salmon Arm	Salmon Arm Forest District Ph: (250) 833-3400 Fax: (250) 833-3399 Forests.SalmonArmDistrictOffice@gems3.gov.bc.ca	850 16th Street NE Salmon Arm, BC Mail: Bag 100 Salmon Arm, BC V1E 4S4
Sechelt	Sechelt Field Office Ph: (604) 740-5005 Fax: (604) 885-3803	Box 4000, 1975 Field Road Sechelt, BC V0N 3A0
Port Alberni	South Island Forest District Ph: (250) 731-3000 Fax: (250) 731-3010 Forests.SouthIslandDistrictOffice@gems3.gov.bc.ca	4885 Cherry Creek Road Port Alberni, BC V9Y 8E9
Squamish	Squamish Forest District Ph: (604) 898-2100 Fax: (604) 898-2191 Forests.SquamishDistrictOffice@gems3.gov.bc.ca	42000 Loggers Lane, Squamish, BC V0N 3G0
Stewart	Stewart Field Office Ph: (250) 636-2663 Fax: (250) 636-2338	Box 918, Sixth and Brightwell Stewart, BC V0T 1W0
Powell River	Sunshine Coast Forest District Ph: (604) 485-0700 Fax: (604) 485-0799 Forests.SunshineCoastDistrictOffice@gems3.gov.bc.ca	7077 Duncan Street, Powell River, BC V8A 1W1

Vanderhoof	Vanderhoof Forest District Ph: (250) 567-6363 Fax: (250) 567-6370 Forests.VanderhoofDistrictOffice@gems3.gov.bc.ca	PO Box 190, 1522 Highway 16 E., Vanderhoof, BC V0J 3A0
Vernon	Vernon Forest District Ph: (250) 558-1700 Fax: (250) 549-5485 Forests.VernonDistrictOffice@gems3.gov.bc.ca	2501-14th Avenue, Vernon, BC V1T 8Z1
Watson Lake	Watson Lake Field Office (May 1 - Aug 31) Ph: (250) 771-4211 Fax: (250) 771-5702	Stikine Road Dease Lake, BC, V0C 1L0
Williams Lake	Williams Lake Forest District Ph: (250) 305-2001 Fax: (250) 305-2034 Forests.WilliamsLakeDistrictOffice@gems3.gov.bc.ca	925 North 2nd Avenue, Williams Lake, BC V2G 4P7

MINISTRY

Victoria	Minister of Forests Ph: (250) 387-6240 Fax: (250) 387-1040	Room 128, Parliament Buildings Victoria, BC V8V 1X4
Victoria	Deputy Minister Ph: (250) 387-4809 Fax: (250) 387-7065 Forests.DeputyMinistersOffice@gems3.gov.bc.ca	Loc.: 4th Floor, 595 Pandora Avenue, Victoria, BC Mailing: PO Box 9525 Stn Prov Govt Victoria BC V8W 9C3
Victoria	Assistant Deputy Minister, Forestry Division (Chief Forester) Ph: (250) 387-1296 Fax: (250) 387-6267 Forests.ForestryDivisionExecutiveOffice@gems3.gov.bc.ca	4th Floor, 595 Pandora Avenue Victoria, BC V8W 9C3

BRANCHES

Victoria	Aboriginal Affairs Branch Ph: (250) 356-6064 Fax: (250) 356-6076 Forests.AboriginalAffairsBranchOffice@gems3.gov.bc.ca	PO Box 9521, Stn Prov Govt 2nd floor - 595 Pandora Avenue, Victoria, BC V8W 3E7
Victoria	Compliance and Enforcement Branch Ph: (250) 356-9841 Fax: (250) 387-2539 Forests.ComplianceAndEnforcementBranchOffice@gems3.gov.bc.ca	PO Box 9505, Stn Prov Govt 2nd Floor, 595 Pandora Street, Victoria BC V8W 9C1
Victoria	Forest Enterprises Branch Ph: (250) 387-1261 Fax: (250) 356-6209 Forest.ForestEnterprisesBranchOffice@gems3.gov.bc.ca	3rd floor, 1450 Government St, PO Box 9510 Stn Prov Govt Vic, BC V8W 9C2

Victoria	Forest Practices Branch Ph: (250) 387-6656 Fax: (250) 387-1467 Forests.ForestPracticesBranchOffice@gems3.gov.bc.ca	PO Box 9513, Stn Prov Govt 1st Floor, 1450 Government Street, Victoria, BC V8W 9C2
Victoria	Research Branch Ph: 387-6721 Fax: (250) 387-0046 Forests.ResearchBranchOffice@gems3.gov.bc.ca	PO Box 9519, Stn Prov Govt 3rd Floor, 712 Yates Street Victoria, BC V8W 9C2
Victoria	Resource Tenures and Engineering Branch Ph: (250) 387-5291 Fax: (250) 387-6445 Forests.ResourceTenuresAndEngineeringBranchOffice@gems3.gov.bc.ca	PO Box 9510, Stn Prov Govt 3rd Floor, 1450 Government Street, Victoria, BC V8W 9C2
Victoria	Resources Inventory Branch Ph: (250) 387-1314 Fax: (250) 387-5999 Forests.ResourcesInventoryBranchOffice@gems3.gov.bc.ca	PO box 9516, Stn Prov Govt 1st Floor, 722 Johnson Street, Victoria, BC V8W 9C2
Victoria	Revenue Branch Ph: (250) 387-1701 Fax: (250) 387-5670 Forests.RevenueBranchOffice@gems3.gov.bc.ca	PO Box 9511, Stn Prov Govt 2nd Floor, 1450 Government Street, Victoria, BC V8W 9C2
Victoria	Timber Supply Branch Ph: (250) 356-5947 Fax: (250) 953-3838 Forests.TimberSupplyBranchOffice@gems3.gov.bc.ca	PO Box 9512, Stn Prov Govt 3rd Floor, 595 Pandora Avenue, Victoria, BC V8W 9C2
Victoria	Tree Improvement Branch Ph: (250) 387-8939 Fax: (250) 356-8124 Forests.TreeImprovementBranchOffice@gems3.gov.bc.ca	PO Box 9518, Stn Prov Govt 3rd Floor - 712 Yates Street Victoria, BC V8W 9C2
Victoria	Library Ph: (250) 387-3628 Fax: (250) 953-3079	PO Box 9523, Stn Prov Govt 4th Floor, 722 Johnson Street Victoria, BC V8W 9C2
NURSERY		
Surrey	Nursery Services Coast Ph: (604) 930-3306 Fax: (604) 775-1288	14275 - 96th Avenue, Surrey, BC V3V 7Z2
Vernon	Nursery Services Interior Ph: (250) 558-1712 Fax:(250) 260-4619	2501 14th Avenue Vernon BC V1T 8Z1
Prince George	Nursery Services Interior - North Ph: (250) 963-9651 Fax: (250) 963-3436	c/o Prince George Region 1011 4th Avenue Prince George BC V2L 3H9
Tappen	Skimikin Nursery	R.R. #1, Site 13, Comp 11

Prince George	Nursery Services Interior - North Ph: (250) 963-9651 Fax: (250) 963-3436	c/o Prince George Region 1011 4th Avenue Prince George BC V2L 3H9
Tappen	Skimikin Nursery Ph: (250) 835-4541 Fax: (250) 835-8633	R.R. #1, Site 13, Comp 11 Tappen Valley Rd., Tappen, BC V0E 2X0
Surrey	Surrey Nursery Ph: (604) 576-9161 Fax: (604) 574-4235	3605-192nd Street, Surrey, BC V4P 1M5

RESEARCH STATIONS

Mesachie Lake	Cowichan Lake Research Station Ph: (250) 749-6811 Fax: (250) 749-6020	PO Box 335 7060 Forestry Road, Mesachie Lake, BC V0R 2N0
Vernon	Kalamalka Forestry Centre Ph: (250) 260-4763 Fax: (250) 542-2230	3401 Reservoir Road, Vernon, BC V1B 2C7

FIRE

Fort Nelson	Fort Nelson Fire Zone Ph: (250) 774-5511 Fax: (250) 774-3704	RR #1, Mile 301 Alaska Highway Fort Nelson, BC V0C 1R0
Fort St. John	Fort St. John Fire Zone Ph: (250) 787-5666 Fax: (250) 787-5672	8808 72nd Street Fort St. John, BC V1J 6M2
Houston	Houston Fire Zone Ph: (250) 845-6227 Fax: (250) 845-6277	Bag 2000 2430 Butler Avenue Houston, BC V0J 1Z0
Invermere	Invermere Fire Zone Ph: (250) 342-4248 Fax: (250) 342-4320	625 Fourth Street Invermere, BC V0A 1K0
Kamloops	Kamloops Fire Centre Ph: (250) 554-5500 Fax: (250) 376-9732	4000 Airport Drive Kamloops, BC V2B 7X2
Kamloops	Kamloops Fire Zone Ph: (250) 554-5502 Fax: (250) 376-2978	4000 Airport Drive Kamloops, BC V2B 7X2
Rock Creek	Kettle Valley Fire Zone Ph: (250) 446-2876 Fax: (250) 446-2774	Mail: Site 40, Comp 11, RR#2 Rock Creek, BC V0H 1Y0 Location: #403 5980 2nd Street Grand Forks Airport, Grand Forks, BC V0H1H4

Nelson	Kootenay Lake Fire Zone Ph: (250) 825-1192 Fax: (250) 825-4081 (Summer only)	RR #1 Site 22, Comp 27 Nelson, BC V1L 5P4
Lillooet	Lillooet Fire Zone Ph: (250) 256-4333 Fax: (250) 256-4367	Bag Service 700 658 Industrial Place Lillooet, BC V0K1V0
Mackenzie	Mackenzie Fire Zone Ph: (250) 565-6124 Fax: (250) 565-6672	Bag 5000 #1 Cicada Road Mackenzie, BC V0J 2C0
McBride	McBride Fire Zone Ph: (250) 569-3705 Fax: (250) 569-3271	PO Box 40, 380 Highway 16 West McBride, BC V0J 2E0
Merritt	Merritt Fire Zone Ph: (250) 378-6402 Fax: (250) 378-6516	Bag 4400, Stn Main 8 Km Highway 5A Merritt, BC V1K 1B8
Revelstoke	North Columbia Fire Zone Ph: (250) 837-7611 Fax: (250) 837-7687	PO Box 9158, RPO #3 1761 Big Eddy Road Revelstoke BC V0E 3K0
Smithers	Northwest Fire Centre Ph: (250) 847-6600 Fax: (250) 847-7470	Bag 5000, Airport Road Smithers BC V0J 2N0
Penticton	Penticton Fire Zone Ph: (250) 770-3700 Fax: (250) 493-7168	3547 Airport Road Penticton, BC V2A 8X1
Port Alberni	Port Alberni Fire Zone Ph: (250) 723-5124 Fax: (250) 723-7921	Courier: Port Alberni Airport Mail: c/o South Island Forest District, 4885 Cherry Creek Road, Port Alberni BC V9Y 8E9
Prince George	Prince George Fire Centre Ph: (250) 565-6124 Fax: (250) 565-6672	1011 4th Avenue Prince George, BC V2L 3H9
Prince George	Prince George Fire Equipment Depot Ph: (250) 565-6026 Fax: (250) 565-6673	3980 - 22nd Avenue Prince George, BC V2N 3A1
Prince George	Prince George Fire Zone Ph: (250) 565-7203 Fax: (250) 565-6760	2000 S. Ospika Blvd Prince George, BC V2N 4W5
Prince Rupert	Prince Rupert Fire Zone Ph: (250) 624-7494 Fax: (250) 624-7479	125 Market Place Prince Rupert, BC V8J 1B9

Quesnel	Quesnel Fire Zone Ph: (250) 992-2144 Fax: (250) 992-9368	601 Airport Road Box 14, Airport Site, RR#8 Quesnel, BC V2J 5E6
Castlegar	Southeast Fire Centre Ph: (250) 365-4040 Fax: (250) 365-4029	RR #1, Site 2, Comp 9 Castlegar Airport Castlegar, BC V1N 3H7
Squamish	Squamish Fire Zone Ph: (604) 898-2122 Fax: (604) 898-2190	42000 Loggers Lane Squamish BC V0N 3G0
Vanderhoof	Vanderhoof/Fort St James Fire Zone Ph: (250) 567-6468 Fax: (250) 567-6456	Box 190 1522 Highway 16 East Vanderhoof, BC V0J 3A0
Salmon Arm	Salmon Arm Fire Zone Ph: (250) 832-5026 Fax: (250) 832-4414	PO Box 3219 1810-40th Street SE, Salmon Arm, BC V1E 4R9

Canadian Forest Service

Natural Resources Canada, Canadian Forest Service
Pacific Forestry Centre
506 West Burnside Road
Victoria, BC V8Z 1M5
Ph: (250) 363-0600
Fax: (250) 363-0775
Web: <http://www.pfc.cfs.nrcan.gc.ca>

Woodlot Association Contact Addresses

Contact List

Boundary Woodlot Association

Box 116
Westbridge, BC
V0H 2B0

Bulkley Woodlot Association

c/o Box 3849
Smithers, BC
V0J 2N0

Cariboo Woodlot Association

c/o Box 81
Likely, BC
V0K 2G0

Chilcotin Woodlot Association

PO Box 38
Alexis Creek, BC
V0L 1A0

Clearwater Woodlot Association

c/o Box 1853, RR#1
Clearwater, BC
V0E 1N0

Columbia Woodlot Association

RR#1, 2500 Upper Road
Golden, BC
V0A 1H0

East Kootenay Woodlot Association

c/o RR#3, Site 5, Comp. 88
Cranbrook, BC
V1C 6H3

Fraser Valley Woodlot Association

c/o 28101 Dewdney Trunk Road
Maple Ridge, BC
V2W 1M1

Kamloops & District Woodlot Association

c/o Jay Springs Ranch
Pinantan Lake, BC
V0E 3E0

Kispiox Woodlot Association

c/o Box 217
Hazelton, BC
V0J 1Y0

Lakes District Woodlot Association

c/o Box 114
Burns Lake, BC
V0J 1E0

Lillooet Woodlot Association

c/o Box 1860
Lillooet, BC
V0K 1K0

MacKenzie Woodlot Association

c/o Box 2198
MacKenzie, BC
V0C 2C0

Merritt District Woodlot Association

c/o Box 2583
Merritt, BC
V1K 1B8

Morice Woodlot Association

c/o Box 80
Houston, BC
V0J 1Z0

North Island Woodlot Association

2456 Stephenson Rd.
Courtenay, BC
V9J 1T7

Peace River Woodlot Association

Box 21030
Dawson Creek, BC
V1G 4X8

Prince George Woodlot Association

Box 1684
Prince George, BC
V2L 4V6

Quesnel Woodlot Association

164 Front Street
Quesnel, BC
V2J 2K1

Robson Valley Woodlot Association

Valemount, BC
V0J 1J0

Sea to Sky Woodlot Association

c/o Box 1309
Mount Currie, BC
V0N 2K0

Shuswap/Okanagan Woodlot Association

c/o 3250 E 19th Avenue NE
Salmon Arm, BC
V1E 1M9

South Cariboo Woodlot Association

Box 2378
100 Mile House, BC
V0K 2E0

South Island Woodlot Association

RR#3, Site 314, Comp. 6
Port Alberni, BC
V9Y 7L7

South Okanagan Woodlot Association

c/o 346 Perth Road
Kelowna, BC
V1X 3R3

Stuart/Nechako Woodlot Association

Box 2126
Vanderhoof, BC
V0J 3A0

West Kootenay Woodlot Association

c/o RR#1, Site 11, Comp. 24
South Slocan, BC
V0G 2G0

Federation of BC Woodlot Associations

Contact Address

Federation of BC Woodlot Associations
Brian McNaughton, General Manager
655 N. Mackenzie Ave.
Williams Lake, B.C. V2G 1N9
tel.: 250-398-7646
gen_manager@woodlot.bc.ca or try: info@woodlot.bc.ca

Education Institutions

University College of the Fraser Valley
33844 King Road
Abbotsford, B.C., V2S 7M9
864-4608, Fax: 855-7588

Kwantlen University College
P.O. Box 9030
Surrey, B.C., V3W 2M8
599-2100, Fax: 599-2068

Malaspina University College (MUC)
900 5th Street
Nanaimo, B.C., V9R 5S5
753-3245, Fax: 755-8725

North Island College (NIC)
2300 Ryan Road
Courtenay, B.C., V9N 8N6
334-5200, Fax: 334-5269

Northern Lights College (NLC)
1401 - 8th Street
Dawson Creek, B.C.,
VIG 4G2
782-5251, Fax: 782-5233

Northwest Community College (NWCC)
5331 McConnell Avenue
Terrace, B.C., V8G 4C2
635-651 1, Fax: 635-351 1

Simon Fraser University (SFU)
The Registrar
Burnaby, B.C., V5A 1S6
291-3111 Fax: 291-4455

Okanagan University College
North Kelowna Campus
3333 College Way
Kelowna, B.C., V1V 1V7
762-5445, Fax: 470-6009

Selkirk College
PO. Box 1200
Caslegar, B.C., VIN 3J1
365-7292, Fax: 365-6569

Vancouver Community College (VCC)
PO. Box 24700, Station F
Vancouver, B.C., V5N 5T9
871-7171, Fax: 871-7451

British Columbia Institute of Technology (BCIT)
3700 Willingdon Avenue
Burnaby, B.C., V5G 3H2
434-5734, Fax: 434-6243

Open Learning Agency
4355 Mathissi Place
Burnaby, B.C., V5G 4S8
431-3000, Fax: 431-3333

Nicola Valley Institute of Technology (NVIT)
Box 399
Merritt, B.C., VOK 2B0
378-3300, Fax: 378-5898

University of Victoria (UVIC)
Admissions Services
PO. Box 1700
Victoria, B.C., V8W 2Y2
721-721 1, Fax: 721-6225

**University of British Columbia
(UBC)**
Faculty of Forestry
270-2357 Main Mall
Vancouver, B.C., V6T 1Z1
822-2727, Fax: 822-8645

Royal Roads University
2005 Sooke Road
Victoria, B.C., V9B 5Y2
391-2511, Fax: 391-2500

**University of Northern British
Columbia (UNBC)**
3333 University Way
Prince George, B.C.,
V2N 4Z9
960-5600, Fax: 960-5537

Other Agencies and Institutions Providing Assistance and Training

The **BC Forestry Continuing Studies Network** serves the forest community by meeting its needs for relevant and timely training in sustainable forest practice. The Network operates from six (6) offices located around the Province. The Provincial Office (UBC, Vancouver) is responsible for overall management and coordination of province-wide training initiatives. The Five Delivery Centres are responsible for organizing and delivering the training activities are associated with public institutions with forestry/natural resource programs: Castlegar (Selkirk College), Kamloops (UC Cariboo), Nanaimo (Malaspina), Prince George (CNC) and Smithers (NWCC).

Forestry Continuing Studies Network Society,
2665 East Mall
Vancouver, BC V6T 1W5
tel: 604-222-9157 fax: 604-222-1730
Email: inquire@fcsn.bc.ca
[www.fcsn.bc.ca]

Consulting Foresters of British Columbia
Box 30133, Saanich Centre Postal Outlet,
Victoria, BC V8X5E1
tel.: 250-384-7161,
[www.cfb.bc.ca]

Council of Forest Industries
200-Two Bentall Centre
555 Burrard Street, PO Box 276
Vancouver, British Columbia V7X 1S7
tel: 604-684-0211
[www.cofi.org]

Indian and Northern Affairs Canada, BC Region
600-1138 Melville St.
Vancouver, BC, V6E 4S3
tel.: 604-775-5100
[www.aime-inac.gc.ca]

Applied Science Technologists and Technicians of BC
[www.asttbc.org]

Other Ministries

Enquiry BC

1-800- 663-7867

Ministries and Organisations

[www.gov.bc.ca/bcgov/popt/orgs/]

Ministry of Water, Land and Air Protection

PO Box 9360 Stn Prov Govt, Victoria BC, V8W 9M2,

tel: 250 387-9422, fax: 250 356-6464

[www.gov.bc.ca/wlap/]

Ministry of Sustainable Resource Management

PO Box 9352 Stn Prov Govt

Victoria, BC V8W 9M2

[www.gov.bc.ca/srm/]

Ministry of Agriculture, Food and Fisheries

PO Box 9058, STN PROV GOVT

Victoria, BC, V8W 9E2

[www.gov.bc.ca/agf/]

FOREST SEEDLING NURSERIES
LOWER MAINLAND AND VANCOUVER ISLAND

Arbordale Nursery
R.R.#2 Site 225
Comp. 32
Courtenay, BC V9N 5M9

Dan Hanson
Tel: 250-338-1069
Fax: 250-338-9799
Em: dhanson@mars.ark.com

Arbutus Grove Nursery
9721 West Saanich Rd.
R.R# 2
Sidney, BC V8L 5T5

Hans Stoffelsma/Ron Webb
Tel: 250-656-4162
Fax: 250-656-0818
Em: hstoffelsma@pinc.com

Cairnpark Nusery Services Inc.
3467 Glenora Road
R.R. #3
Duncan, B.C. V9L 2X1

Tim Hale
Tel: 250-715-0559
Fax: 250-715-0559
Em: tjhale@island.net

Hybrid Nurseries
12682 Woolridge Road
Pitt Meadows, B.C.
V3Y 1Z1

Burce Morton/ Eileen Brader
Tel: 604-465-6276
Fax: 604-465-9829
Em:

PRT – Campbell River Nursery
3820 Snowden Rd.
Campbell River, B.C
V9H 1P5

Tom Harvey/Burt Fleming
Tel: 250-286-1224
Fax: 250-286-1229
Em: campbellriver@prtgroup.com

PRT – Reid, Collins
Box 430
2396-272nd Street
Aldergrove, B.C
V4W 2T9

Lauchlan Glen/Reg Remmer
Tel: 604-856-6408
Fax: 604-856-4218
Em: reidcollins@prtgroup.com

Pelton Reforestation Ltd.
12930-203 Street
Maple Ridge, B.C.
V3Z 1A

Norm Pelton/Steve Pelton
Tel: 604-465-4511
Fax: 604-465-7719
Em: Spelton@pelton.com

Sylvan Vale Nursery Ltd
2104A Kelland Road
Black Creek, B.C.
V9J 1G4

Iola Wedman/Siriol Paquet
Tel: 250-337-8487
Fax: 250-337-5898
Em: SVN@bc.sympatico.ca

Conversion Factors

Information Resources

Imperial to Metric Conversions

Metric to Imperial Conversions

Imperial Units

Metric Equivalents

Metric Units

Imperial Equivalents

Length

1 chain	20.116 m
1 foot	0.305 m
1 inch	2.54 cm
1 mile	1.609 km
1 yard	0.914 m

Length

1 cm (centimetre)	0.394 inch
1 km (kilometre)	0.621 mile
1 m (metre)	0.05 chain
1 m (metre)	3.281 feet
1 m (metre)	1.094 yards

Area

1 acre	0.405 ha
1 mil-acre	4.047 m ²
1 square foot	0.093 m ²
1 square inch	6.452 cm ²
1 square mile	2.59 km ²
1 square yard	0.836 m ²

Area

1 cm ² (square centimetre)	0.155 square inch
1 ha (hectare)	2.471 acres
1 km ² (square kilometre)	0.386 square mile
1 m ² (square metre)	0.274 mil-acre
1 m ² (square metre)	10.764 square feet
1 m ² (square metre)	1.196 square yards
1 m ² (square metre)	

Volume or Capacity

1 cord	3.625 m ³ (stacked)
1 cubic foot	0.028 m ³
1 cubic yard	0.765 m ³
1 cunit	2.832 m ³
1 gallon	4.546 I

Volume or Capacity

1 L (litre)	0.220 gallon
1 m ³ (cubic metre)	35.315 cubic feet
1 m ³ (cubic metre)	1.308 cubic yards
1 m ³ (cubic metre)	0.353 cunit
1 m ³ (stacked, stacked m ³)	0.276 cord

Mass or Weight

1 ounce	28.350 g
1 pound	0.454 kg
1 ton	0.907 t

Mass or Weight

1 g (gram)	0.035 ounce
1 kg (kilogram)	2.205 pounds
1 t (tonne)	1.102 tons

Ratios

1 cord per acre	8.956 m ³
1 cubic foot per acre (stacked)/ha	

Ratios

1 kg/m ³ (kilogram per m ³)	0.062 pound/cu.ft.
	2.825 miles per

1 mile per gallon	0.070 m ³ /ha	1 km/l (kilometre per	gallon
1 pound per cubic	0.354 km/l	litre)	4.356 square ft./acre
foot	16.019 kg/m ³	1 m ² /ha (m ² per hectare)	14.291 cu.ft./acre
1 square foot per	0.230 m ² /ha	1 m ³ /ha (m ³ per hectare)	0.112 cord per acre
acre	2.242 t/ha	1 m ³ (stacked)/ha	0.446 ton per acre
1 ton per acre		1 t/ha (tonne per hectare)	

In case you were wondering.....

chain= 22 yd

cord= 128 stacked ft³

cunit= 100 ft³ of solid wood

ton= 2,000 lb

tonne= 1000 kg